

## Increased street tree planting

### Objectives

- O4. To improve the walkability of streets adjacent to Victoria Road to make it more appealing for pedestrians to access shops and services.
- O5. To enhance the appearance and amenity of the area, improve the local micro-climate, provide native fauna and flora habitats and control climatic impacts on buildings and outdoor spaces.

### Controls

|     |  |
|-----|--|
| C7. | New street tree planting should concentrate along identified 'Street tree priority areas' i.e. Formosa Street, Renwick Street and the southern part of Wrights Road as identified in <b>Fig G3.7</b> and <b>Fig G3.8</b> .                                 |
| C8. | In the identified priority areas, undergrounding of power lines should occur wherever possible to enable street trees to grow to mature levels. If undergrounding is not possible, and where appropriate, the bundling of power lines would reduce impact. |

## Landscape quality

### Objectives

- O6. New development is to promote high quality landscape design as an integral component of the overall design.
- O7. Provide native flora and fauna habitats and control climatic impacts on buildings and outdoor spaces.
- O8. Allow adequate provision on site for infiltration of stormwater, deep soil tree planting, landscaping and areas of communal outdoor recreation.

### Controls

|      |   |
|------|---|
| C9.  | A 1m setback along Formosa Street and a 0.5m setback along Victoria Road is to be provided at appropriate locations to allow for landscaping. |
| C10. | New developments on street corners are to provide high quality landscaping and public seating.  |
| C11. | Landscaping is to be used to separate pedestrians from traffic, especially in 'no stopping' zones.  |

## Formosa Street pedestrianisation

### Objectives

- O9. To provide additional landscaping and pedestrian space along Formosa Street improving pedestrian amenity and active transport (walking, cycling).
- O10. To provide a high quality pedestrian environment in the 'heart' of Drummoyne within close proximity to existing retail and community facilities.

### Controls

|      |  |
|------|--|
| C12. | Investigate the opportunity to convert the northern end of Formosa Street north of Bowman Street into a pedestrianised zone identified in <b>Fig G3.7</b> as 'Priority area for streetscape pedestrianisation'. The proposed design options include: <ul style="list-style-type: none"> <li>• Closure to all through traffic to and from Lyons Road (see <b>Fig G3.3</b>); or</li> <li>• Limited through traffic via a one-way system.</li> </ul> <p>Pedestrianisation of this space would need to retain vehicular access to adjacent properties via a shared, slow speed zone and provide the opportunity for seating, landscaping and public art.</p> |
| C13. | New development that fronts onto the Formosa Street priority area for streetscape pedestrianisation must: <ul style="list-style-type: none"> <li>• minimise the number and width of vehicular driveways across the footpath;</li> <li>• ensure building entries are clearly visible and pedestrian access to entries and lobbies is direct;</li> <li>• maximise the number of doors and windows overlooking the street; and</li> <li>• provide a landscaped front setback with substantial vegetation (except along active frontages).</li> </ul>  |
| C14. | Investigate opportunities for the widening of footpaths and installation of landscaped street blisters at intersections along the entire length of Formosa Street.   |



Fig G3.1 Potential design option for a public space on Church Street between Victoria Road and Formosa Street



Fig G3.2 Proposed alternative option for Church Street with public space and one-way traffic from Victoria Road



A public space in the centre of Five Dock, with mature trees providing shade and a cooler micro-climate



Example of a public square with good solar access, seating facilities and active frontages

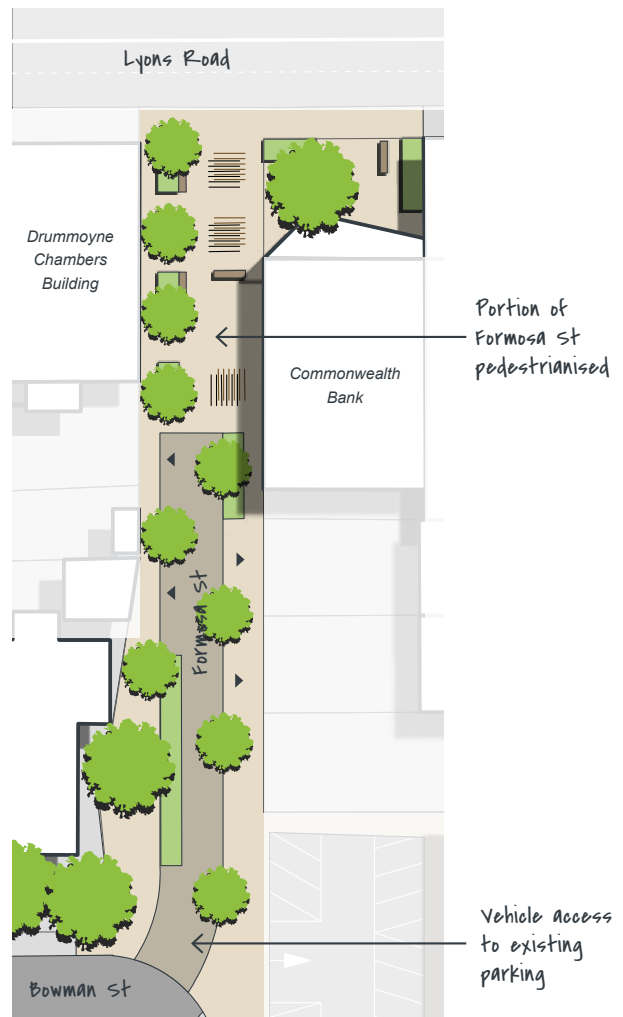

Fig G3.3 Potential design of the pedestrianised Formosa Street and the opportunity for a public space towards Victoria Road

## Church Street

### Objectives

- O11. To provide additional landscaping and pedestrian space along Church Street.
- O12. To improve pedestrian amenity and active transport (walking, cycling) within the linear Victoria Road business/ retail core.

### Controls

- |      |  |
|------|--|
| C15. | Investigate the opportunity to create a public space, via the partial or complete closure of Church Street, between Victoria Road and Formosa Street as shown in <b>Fig G3.8</b> .<br><br>Possible design options are shown in <b>Fig G3.1</b> and <b>Fig G3.2</b> . Additional traffic studies would be required to determine what the ideal option would be. It may be possible to consider a hybrid option that would involve a timed directional flow. |
|------|--|

## Pedestrian links

### Objectives

- O13. To improve pedestrian permeability and increase activity levels of the centre as a whole.

### Controls

- |      |  |
|------|--|
| C16. | Existing mid-block links as identified in <b>Fig G3.7</b> are to be retained.  |
| C17. | Upgrade and where possible widen existing mid-block links. Design treatments should include: <ul style="list-style-type: none"> <li>• Good lighting levels;</li> <li>• Clear sight lines;</li> <li>• Permanent and temporary art and installations;</li> <li>• Landscaping;</li> <li>• Active uses trading to the link, where possible;</li> <li>• High quality paving/ surface treatments.</li> </ul> |

- |      |  |
|------|--|
| C18. | Wherever possible, long blocks are broken up with new high quality pedestrian prioritised links, particularly where new connections would facilitate access to public transport, open spaces and community facilities. |
|------|--|

All new development is to consider the provision of new through site links, particularly where opportunities exist to connect retail and commercial uses along Victoria Road to parking and access along quieter streets such as Formosa Street.

Locations for two 'Desired future pedestrian links' are identified in **Fig G3.7**. Both connect Formosa Street with Victoria Road, one as an extension of Bowman Street and the other south of Edwin Street.

- |      |   |
|------|---|
| C19. | New pedestrian links should be at least 5m wide, naturally lit and ventilated where possible, appropriately lit after hours, publicly accessible 24/7, and have clear sightlines from end to end. |
|------|---|

## Visually prominent locations

- O14. To significantly improve the visual quality of the precinct by focussing on the design quality of prominent locations i.e. corner sites and localities at the end of terminating views.

### Controls

- |      |   |
|------|---|
| C20. | Development on sites identified as a prominent corner and/or at the end of a terminating view in <b>Fig G3.7</b> and <b>Fig G3.8</b> must pay particular attention to overall design quality due to the location's high visibility and impact on the local character, i.e. well proportioned facades, architectural detail, and quality materials and finishes. |
|------|---|

**Public art**

**Objectives**

O15. To provide a connection to the area's history and local stories, and enhance the pedestrian experience of the public domain.

| Controls |  |
|----------|--|
| C21.     | Large expanses of blank walls of new development should be utilised as a 'canvas' for art that has meaning and connection with the local community.  |
| C22.     | Smaller pieces of public art should be incorporated into the public domain wherever possible. Key locations are identified in <b>Fig G3.7</b> and <b>Fig G3.8</b> and include the proposed POPs, the new public place on Church Street and the pedestrianised section of Formosa Street. |
| C23.     | Preference should be given to items that are at pedestrian level and scale, and multi-functional and/or interactive, e.g. pieces children can play on or with.   |

**Smart poles**

**Objectives**

O16. To improve the visual quality of the centre in particular along Victoria Road.

| Controls |  |
|----------|--|
| C24.     | When required and in coordination with RMS, existing older-style timber light poles should be replaced with 'smart poles' able to carry banners. |



*Built form on visually prominent locations and corners require the highest architectural design quality*



*For the Victoria Road Centre, quality pedestrian links to Formosa Street are crucial for its future success*



*Public art as an interactive play piece*

## Lighting

### Objectives

- O17. To enhance safety across the centre and discourage anti-social behaviour.
- O18. To increase the amenity of footpaths and public places after hours increasing activity levels.
- O19. To promote the civic image of the centre.

### Controls

|      |   |
|------|---|
| C25. | <p>New development is to incorporate a variety of lighting sources. As a minimum the following is to be provided:</p> <ul style="list-style-type: none"> <li>• Pedestrian level lighting under awnings or mounted on ground level facades that sufficiently illuminates footpaths and any pedestrian links;</li> <li>• Indirect lighting within shopfronts and tenancies that softly 'spills' onto the footpath after hours; and</li> <li>• Indirect soft lighting of upper level facades or architectural details (note: care should be taken so that there is no light spill into apartments through windows).</li> </ul> |
| C26. | <p>Public domain lighting is to be maximised and should include a wide variety of sources such as bollards and other street furniture, street lighting at pedestrian scale and uplighting of trees.</p>   |

## Night-time economy

### Objectives

- O21. To provide a stimulus for a night-time economy within the centre and encourage clusters of businesses that also utilise suitable outdoor spaces.

### Controls

|      |   |
|------|---|
| C27. | <p>Establish a late night trading area (to midnight or 2 am) for shops, businesses and low-impact food and drink venues that trade off Victoria Road and/or the new public place on Church Street. (Note: the new hours would only apply if patrons enter and exit the venue from Victoria Road and not via a laneway or residential area).</p> |
|------|---|

|      |  |
|------|--|
| C28. | <p>Establish a new category of trading hours for unlicensed shops, such as bookstores and clothing shops, service businesses e.g. gyms, dry cleaners and hairdressers, and public facilities e.g. libraries and community centres.</p> |
| C29. | <p>Encourage weekend markets, events and small festivals, and support venues for live music such as hotels and restaurants,</p>  |

## Maximum building height

### Objectives

- O22. To ensure new development reinforces the desired streetscape character and where appropriate retains the character of established residential areas.
- O23. To provide a sense of enclosure to the street and contribute to a consistent built form scale across the precinct over time.
- O24. To create a more consistent height modulation along Victoria Road that follows the topography rather than emphasising the ridges.

### Controls

|      |   |
|------|---|
| C30. | <p>New development is to conform with the maximum heights as shown in <b>Fig G3.9</b> and <b>Fig G3.10</b> (Building Envelopes Control Plans) and <b>Fig G3.11</b> to <b>Fig G3.15</b> (Building Envelopes Control Sections).</p> |
|------|---|

## Number of storeys

### Objectives

- O26. To avoid 'sunken' ground floors below footpath level resulting in a poor quality streetscape and pedestrian activation.

### Controls

|      |   |
|------|---|
| C31. | <p>New development is to conform to the maximum number of storeys as shown in <b>Fig G3.9</b> and <b>Fig G3.10</b> (Building Envelopes Control Plans) and <b>Fig G3.11</b> to <b>Fig G3.15</b> (Building Envelopes Control Sections).</p> |
|------|---|

### Street wall height

#### Objectives

- O27. To help facilitate a gradual manifestation of consistent building scales and coherence along streetscapes and spatially enclose the street.
- O28. To minimise bulk and scale impact and help mitigate the pedestrian’s perception of building height.
- O29. To allow adequate sunlight and minimise shadow impacts on the public domain.
- O30. To avoid a 'canyon' effect along Victoria Road in particular, where the sloping topography accentuates perceived building scale.

| Controls |   |
|----------|---|
| C32.     | The maximum street wall height across the centre varies between 2 and 4 storeys as illustrated in <b>Fig G3.9</b> and <b>Fig G3.10</b> (Building Envelopes Control Plans) and <b>Fig G3.11</b> to <b>Fig G3.15</b> (Building Envelopes Control Sections). |
| C33.     | Building elements above the street wall height, such as balustrades, partition walls or roof overhangs must be set back at least 2.5m from the street wall height as illustrated in <b>Fig G3.4</b> (Typical built form interface section).               |
| C34.     | Where frontages are more than 20 metres wide, building massing must be vertically articulated.  |
| C35.     | Where built-to alignments apply, buildings should have a minimum of 75% of their frontage built to the nil setback. The remaining 25% may be set back up to 2 metres to provide areas for entrances, landscaping, bike parking, outdoor seating etc.      |

### Floor to floor heights

#### Objectives

- O31. To address the need to revitalise the retail functions along Victoria Road, promote higher quality ground floor retail spaces and avoid sunken frontages below footpath level.
- O32. To ensure buildings are adaptable to a variety of uses over time.

| Controls    |  |                                 |
|-------------|--|---------------------------------|
| C36.        | Minimum floor to floor heights for Victoria Road Drummoyne are as follows: |                                 |
| Use         | Minimum floor to floor height  | Minimum floor to ceiling height |
| Retail      | 4.4m   | 4m                              |
| Adaptable   | 3.7m   | 3.3m                            |
| Commercial  | 3.7m   | 3.3m                            |
| Community   | 3.7m   | 3.3m                            |
| Residential | 3.1m   | 2.7m                            |

Note: The ground floor is retail, commercial or community use. Residential use on the ground floor is not permitted in the centre.

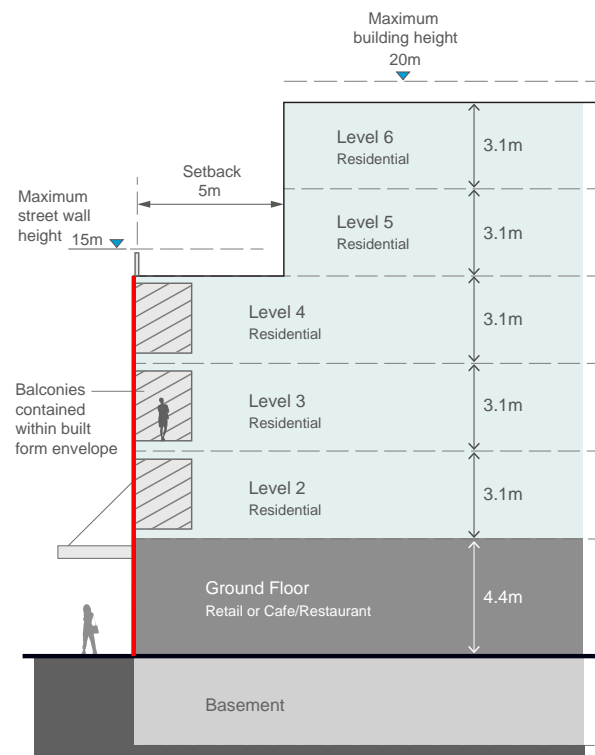

Fig G3.4 Typical built form interface section

### Upper level setbacks

#### Objectives

- O33. To define the proportion, scale and visual enclosure of the public domain and provide a level of consistency across the precinct.
- O34. To lessen the visual impact of taller development and help create a more unified, human-scale streetscape environment.

| Controls |   |
|----------|---|
| C37.     | Upper level setbacks are required towards most public domain interfaces as identified in <b>Fig G3.9</b> and <b>Fig G3.10</b> (Building Envelopes Control Plans) and <b>Fig G3.11</b> to <b>Fig G3.15</b> (Building Envelopes Control Sections).      |
| C38.     | The upper-most level(s) above the street wall height must be designed so that they are visually unobtrusive. Ways to achieve this include the use of lightweight construction techniques, dark colours and/or roof elements that create deep shadows. |
| C39.     | If a development is more than 50 metres in length and higher than 4 storeys it should provide a vertical break in the built form for the upper two storeys.   |

### Transition to lower scale residential

#### Objectives

- O35. To limit impacts of new development on surrounding lower density residential, i.e. loss of outlook, privacy and sun access.

| Controls |   |
|----------|---|
| C40.     | <p>New development on the eastern side of Victoria Road with a rear boundary to properties addressing Renwick Street must:</p> <ul style="list-style-type: none"> <li>• set back 3m as identified in <b>Fig G3.9</b> and <b>Fig G3.10</b> (Building Envelopes Control Plans) and <b>Fig G3.11</b> to <b>Fig G3.15</b> (Building Envelopes Control Sections). The setback area is to be a deep soil zone. Basements are not permitted to encroach into this zone.</li> <li>• step back and strictly adhere to a 30 degree height plane measured from 3.6m above natural ground level at the boundary as identified in <b>Fig G3.9</b> and <b>Fig G3.10</b> (Building Envelopes Control Plans) and <b>Fig G3.11</b> to <b>Fig G3.15</b> (Building Envelopes Control Sections).</li> <li>• have deep planters and partially solid balustrades (minimum 80% solid) designed to prevent views from apartments into the rear gardens/ rear habitable rooms of properties on Renwick Street as identified in <b>Fig G3.5</b>.</li> </ul> |
| C41.     | New development between Victoria Road, Day Street, Thornley Street and Formosa Street must have deep planters and partially solid balustrades (minimum 80% solid) on south facing balconies designed to prevent downward views from apartments into adjacent properties similar to <b>Fig G3.5</b> .  |

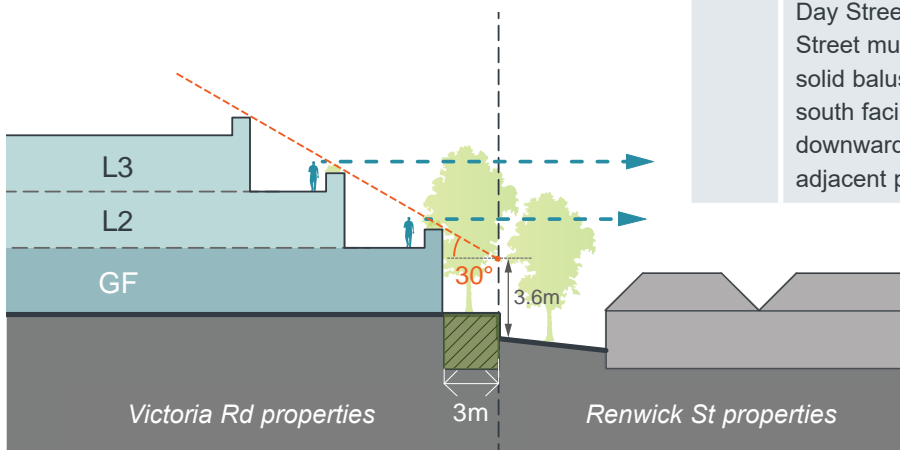

Fig G3.5 A 3m deep soil zone and solid balustrades of new development will reduce overlooking of neighbouring rear gardens

## Primary active frontages

### Objectives

- O36. To increase pedestrian activity and support the economic success of the area, particularly along Victoria Road.
- O37. To create diversity, avoid vehicle access points and shelter pedestrians from the weather along key pedestrian routes.

### Controls

|      |   |
|------|---|
| C42. | Ground level active uses and a continuous cantilevered awning must be provided along 'Primary active frontages' as identified in <b>Fig G3.9</b> and <b>Fig G3.10</b> .   |
| C43. | All primary active frontages must apply the design guidance outlined in Section G2 General Requirements, <b>Fig G2.2</b> .  |
| C44. | Ground level active uses/ tenancies must be minimum of 10m deep and be accessible without steps. Entries have a finished floor level that is at the same level as the footpath. Where this is not possible, entries are no greater than 0.4m above or below the footpath. Entries below footpath level are not permissible. |
| C45. | Residential entries and foyers are permitted along active frontages, however, they are not to compromise the commercial activity along the street by keeping their frontage width to a minimum. The maximum width for residential entries/ foyers is 6m.  |
| C46. | Vehicle access points are generally not permitted along active frontages. Where no alternative access point can be provided, their width must be kept to an absolute minimum.   |

## Secondary active frontages

### Objectives

- O38. To enhance the appearance, attractiveness and safety of streets close to the main commercial activity.

### Controls

|      |   |
|------|---|
| C47. | The interface of ground floors along 'Secondary active frontages' as identified in <b>Fig G3.9</b> and <b>Fig G3.10</b> must: <ul style="list-style-type: none"> <li>• consider the design requirements for primary active frontages;</li> <li>• display a high degree of architectural detail and interest;</li> <li>• use high quality materials and finishes;</li> <li>• maximise pedestrian safety at driveway cross overs and vehicular access points;</li> <li>• maximise the number of doors/ entries and windows; and</li> <li>• incorporate lighting that illuminates the footpath after hours.</li> </ul> |
|------|---|

## Balconies

### Objectives

- O40. To not add to the built form visual bulk and scale.
- O41. To provide passive surveillance of the public domain.

### Controls

|      |   |
|------|---|
| C48. | All balconies must be wholly contained within the building envelope. Forward protrusion beyond the envelope is not permissible.   |
| C49. | Balconies should be designed so that they strike a balance between visual privacy for the resident and opportunities to overlook the public domain. Design treatment may include a combination of solid and transparent balustrade materials. |



**Heritage and conservation**

**Objectives**

- O42. To provide a link to the history of the Victoria Road centre and showcase the area's historic charm.
- O43. To recognise and support the significant contribution of heritage items to the character, cultural value and identity of the area.
- O44. To protect heritage buildings/ items and their visual setting or 'curtilage'.

| Controls |   |
|----------|---|
| C50.     | New development in the proximity of the intersection of Victoria Road and Lyons Road, which has a pocket of heritage listed and contributory items, is to consider appropriate external paint schemes and sympathetic building signage.   |
| C51.     | Additional information signage about the area's history, located either in the public domain or on building facades, is to be provided wherever possible.   |
| C52.     | External facade lighting should be installed to highlight the architectural features of contributory buildings after dark.  |
| C53.     | Development in the vicinity of a heritage item, within a heritage conservation zone or a contributory zone, protects and enhances the cultural significance of nearby heritage items and streetscape character.   |
| C54.     | Where development is adjacent to a heritage item, contributory building or within a conservation area, a variation to the street wall height of the new development may be required.  |
| C55.     | Alterations and additions respond appropriately to the heritage fabric but do not mimic or overwhelm the original building. Designs are contemporary and identifiable from the existing building. Ways to separate the new work from the existing include providing generous setbacks between new and old, using a glazed section to link the new addition to the existing building and/or using shadow lines and gaps between old and new. |

|      |   |
|------|---|
| C56. | Building and facade design responds to the scale, materials and massing of heritage items through aligning elements such as eaves lines, cornices and parapets, facade articulation, proportion and/or rhythm of existing elements and complementary colours, materials and finishes. |
| C57. | Signs on heritage buildings, including painted lettering, should be carefully located and should be sympathetic to the historic nature of the building. Adjacent signs should be designed and applied sympathetically.  |
| C58. | Where new development directly adjoins a listed heritage building, the appropriate building setback and height will be determined on a case-by-case basis having regard to the views, vistas and context of the heritage item.  |
| C59. | Highlight the assets of heritage buildings at the intersection of Lyons Road and Victoria Road by lighting the facades after dark and providing an adjacent high-quality public domain.   |



Examples of information integrated into the public domain, highlighting the history of the area and its buildings

### Green walls and roofs

#### Objectives

O45. To enhance the appearance and amenity of the area, create biodiversity and improve micro-climate conditions.

#### Controls

- C60. New development should consider the incorporation of landscape elements and greenery such as:
- Vertical planting/ green walls;
  - Facade indentations for landscaping; and
  - Green roofs.



Example of a vertical green wall, Central Park Sydney

### Awnings and street trees

#### Objectives

O46. To provide for a balance of weather protection for pedestrians and the ability for mature street trees.

#### Controls

- C61. Particularly along Victoria Road, new development should consider the provision of 'breaks' in awnings to allow for street tree planting.



Example of an awning design with 'breaks' and street tree planting at 81-110 Victoria Road

### Residential uses along Victoria Road

#### Objectives

O47. To provide a high level of amenity for future building users and protect from negative impacts (noise, air quality, vibration).

| Controls |  |
|----------|--|
| C62.     | Development along Victoria Road is to consider the guidance in <i>Busy Roads Interim Guidelines</i> and the design approaches illustrated in <b>Fig G3.6 Noise mitigating facade treatments</b> , source: <i>Development Near Rail Corridors And Busy Roads Interim Guideline, NSW</i> . |
| C63.     | Noise sensitive areas (living rooms, bedrooms) are located away from Victoria Road where possible.   |
| C64.     | Windows located towards Victoria Road are double-glazed (or laminated glazing) and have acoustic seals.  |
| C65.     | Habitable rooms of dwellings are to be designed to achieve internal noise levels of no greater than 50dBA.   |

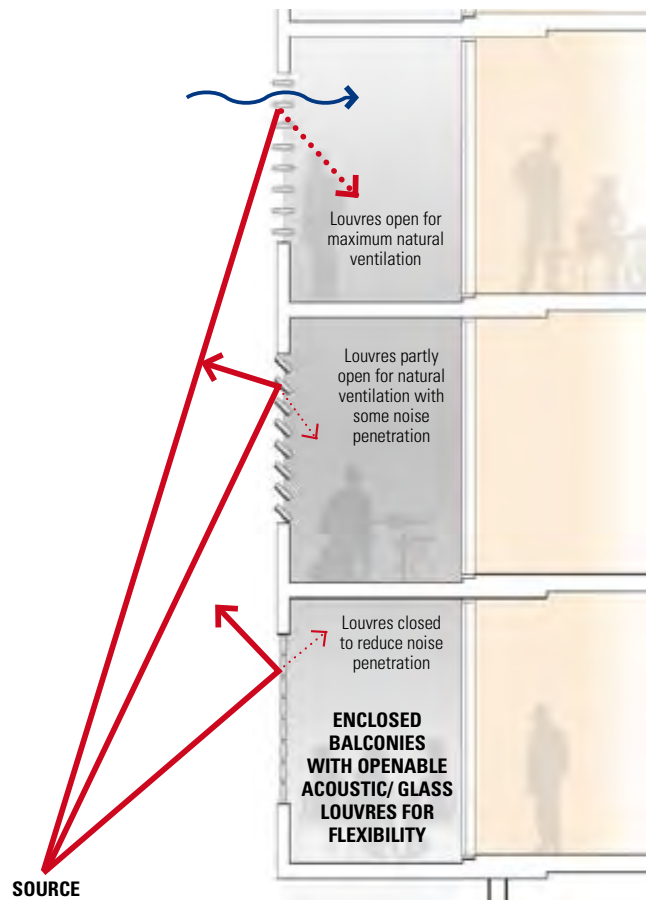
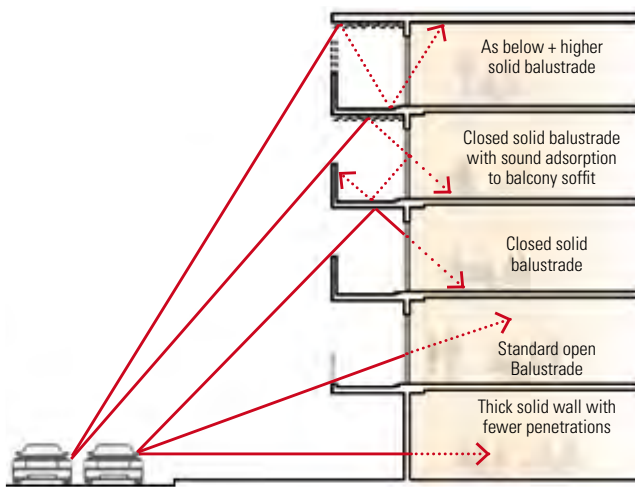

Fig G3.6 Noise mitigating facade treatments  
 (Source: *Development Near Rail Corridors And Busy Roads Interim Guideline, NSW*)

## Visual privacy

### Objectives

O48. To protect the visual privacy of lower scale residential properties addressing Renwick Street.

#### Controls

|      |   |
|------|---|
| C66. | The interface of new development that shares a rear boundary with properties addressing Renwick Street must provide solid balustrades and screening vegetation as shown in <b>Fig G3.5</b> . Solid balustrades and screening also required for south and south-west facing balconies or terraces for buildings between Victoria Road, Day Street, Thornley Street and Formosa Street. |
|------|---|

## On-street parking and loading

#### Controls

|      |  |
|------|--|
| C67. | New developments must not rely on Victoria Road on-street parking to meet parking and/or loading/delivery requirements or to facilitate access to the development and/or any associated commercial uses. |
|------|--|

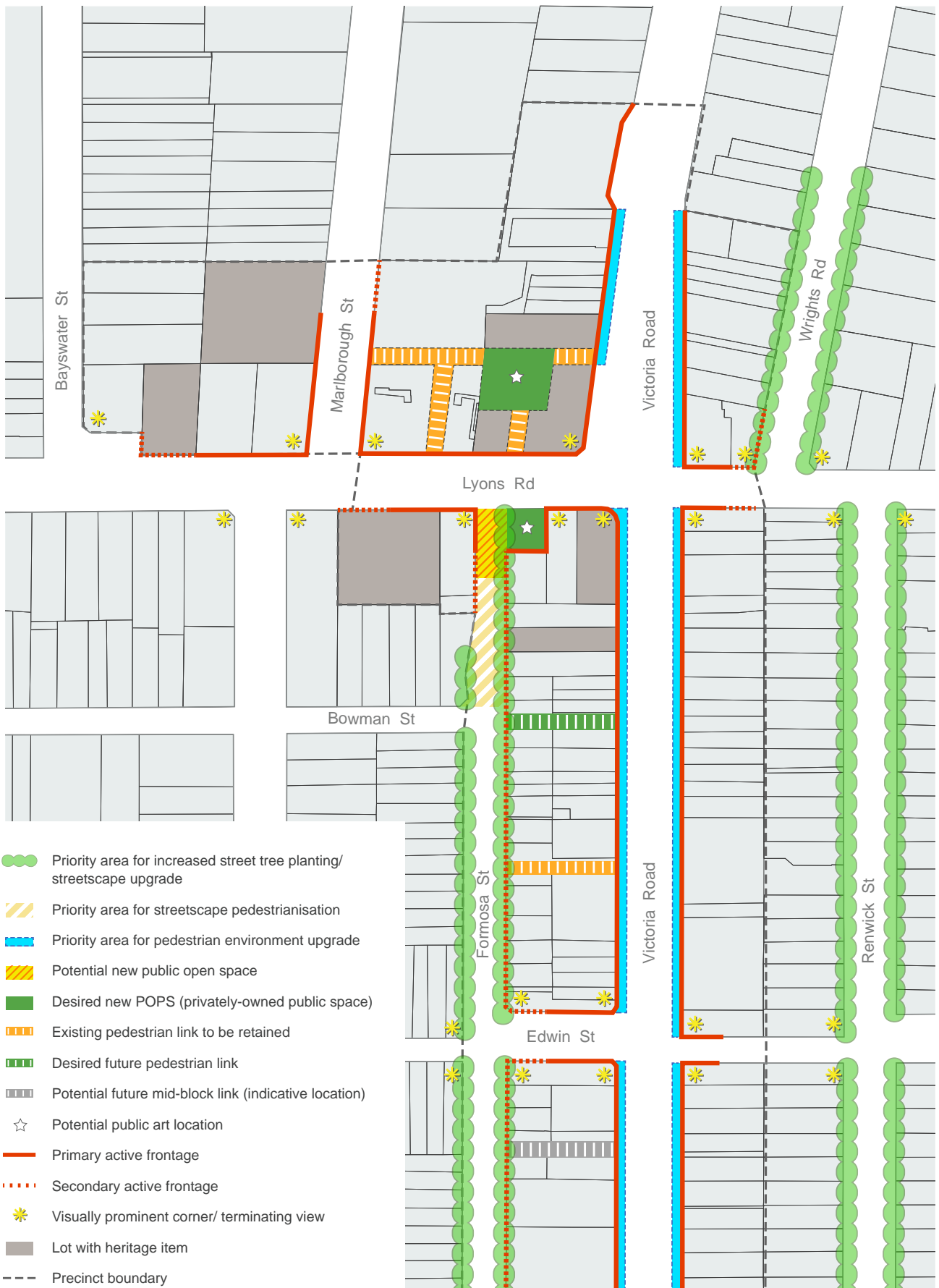

Fig G3.7 Public Domain Plan (north-west)

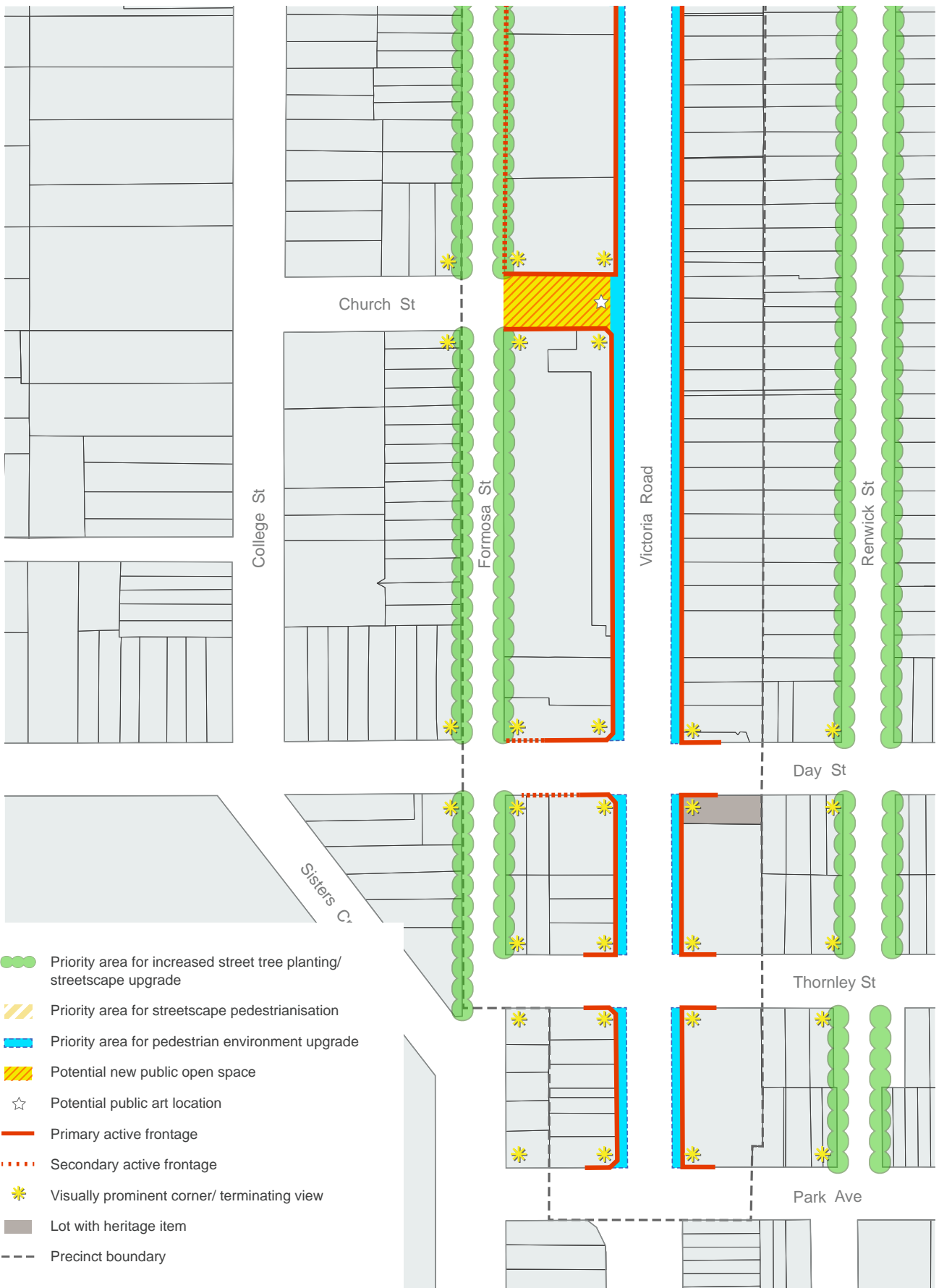

Fig G3.8 Public Domain Plan (south-east)



Fig G3.9 Built Form Envelope Controls Plan (north-west)



Fig G3.10 Built Form Envelope Controls Plan (south-east)



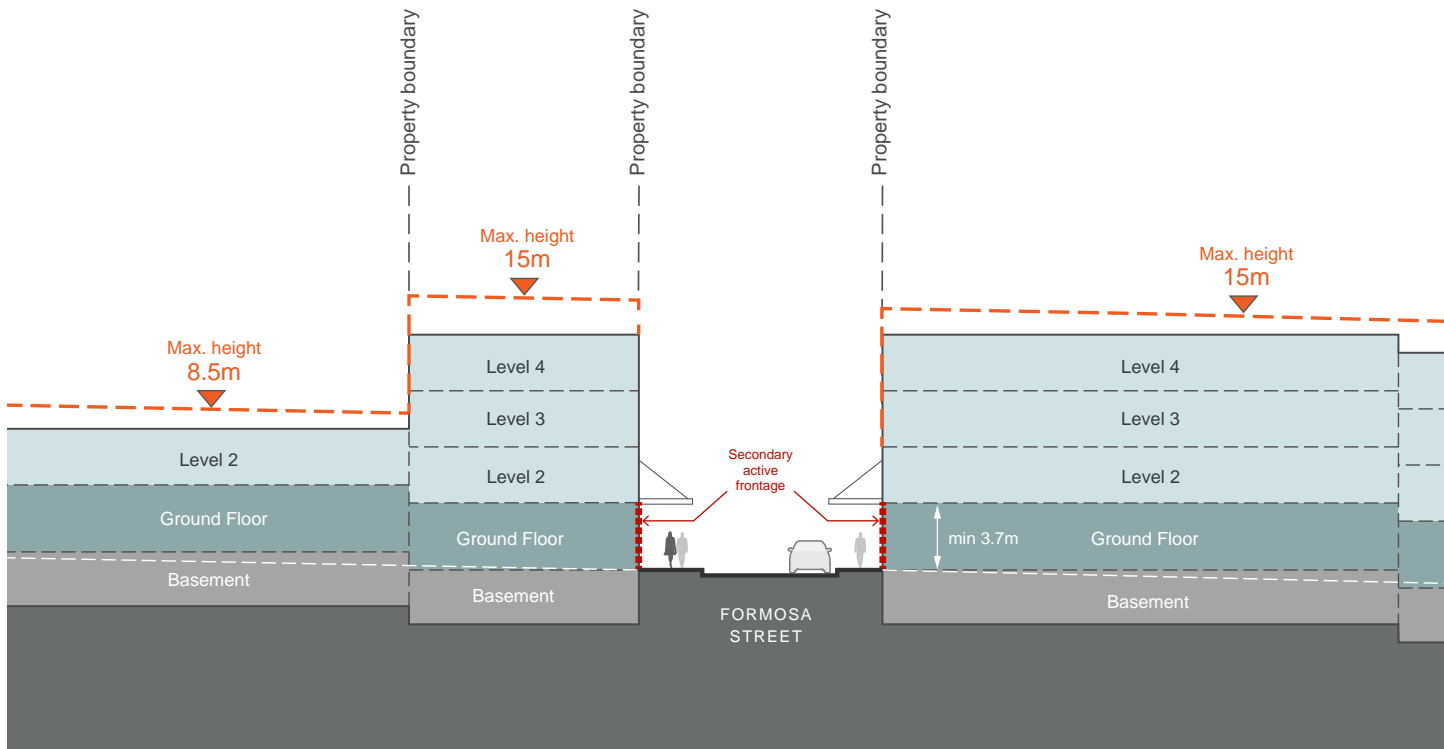
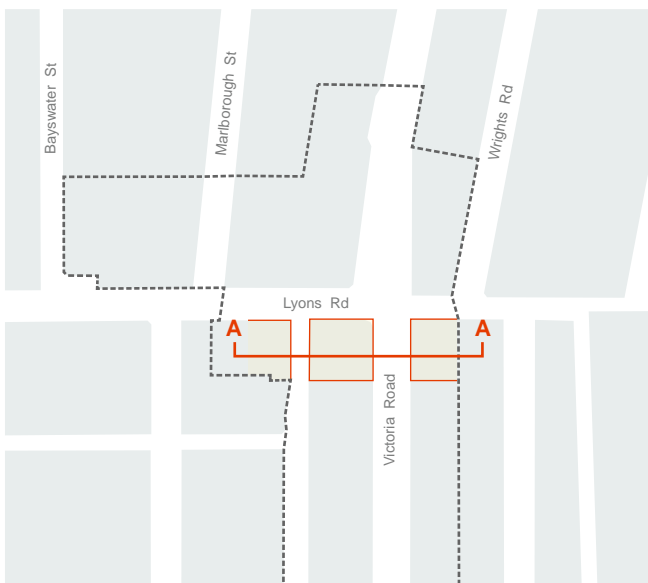
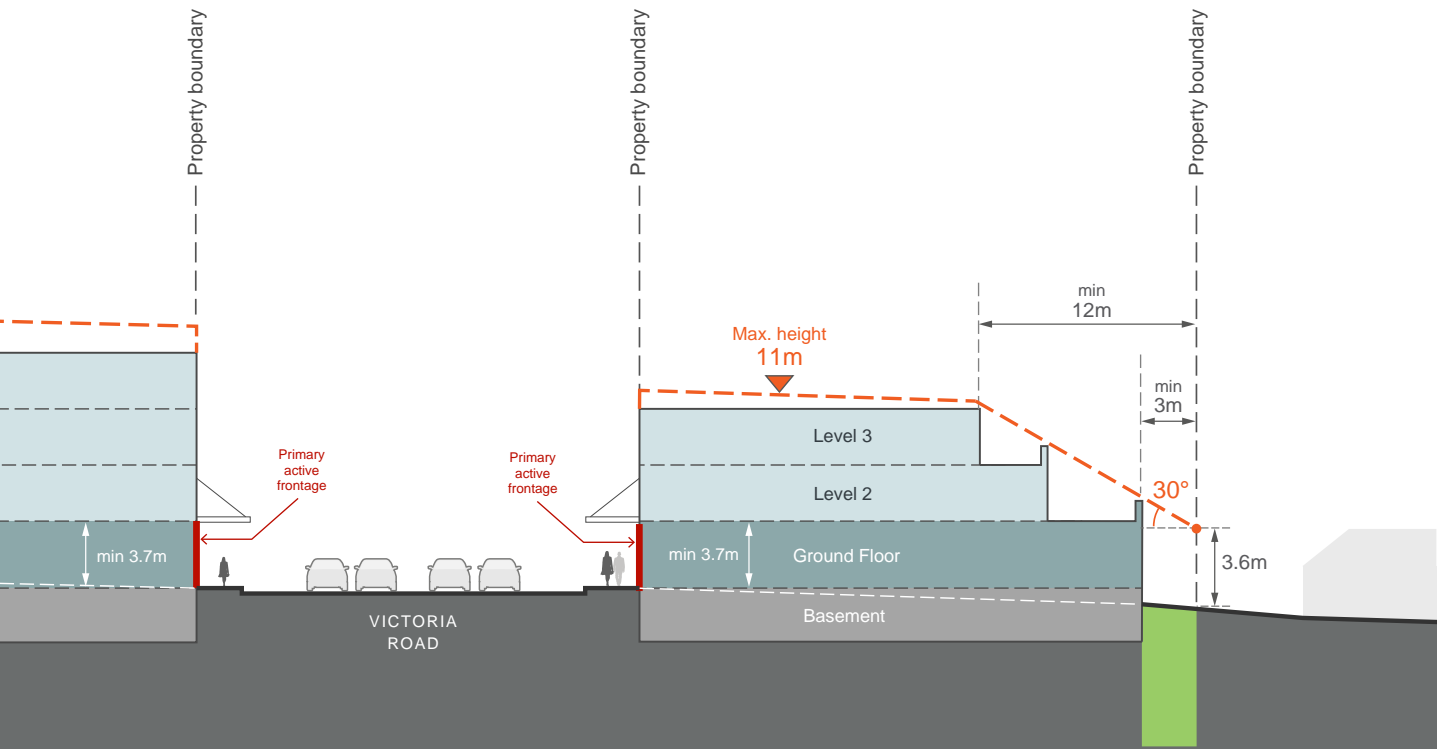

Fig G3.11 Built Form Envelope Section A



Key Plan Section A



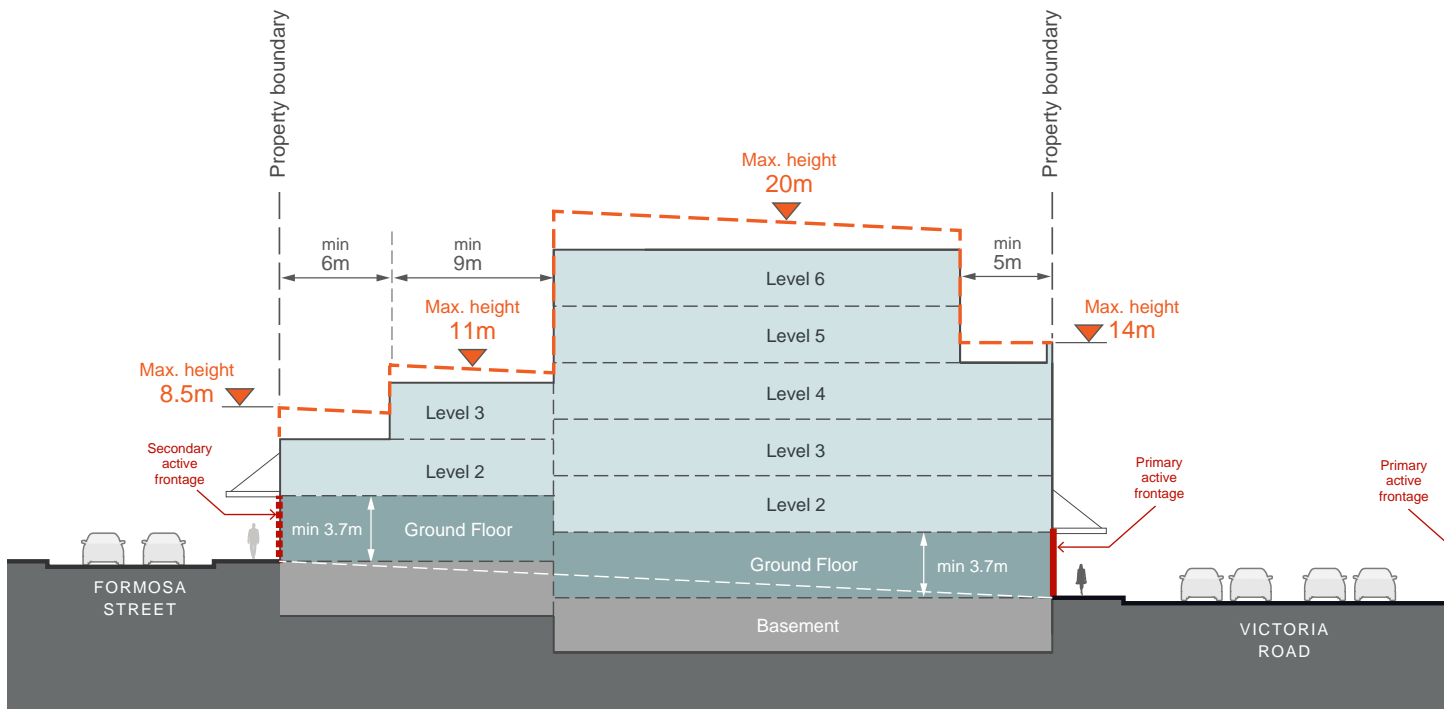

Fig G3.12 Built Form Envelope Section B

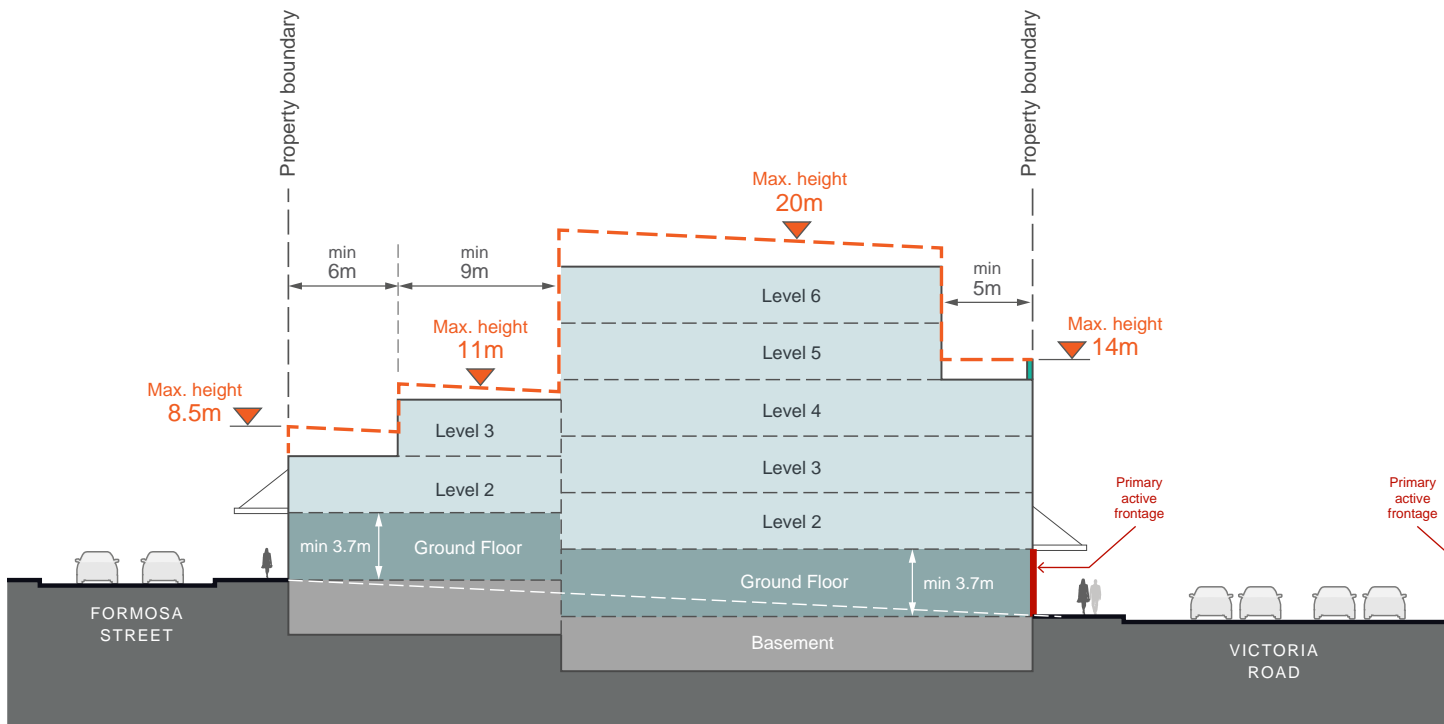
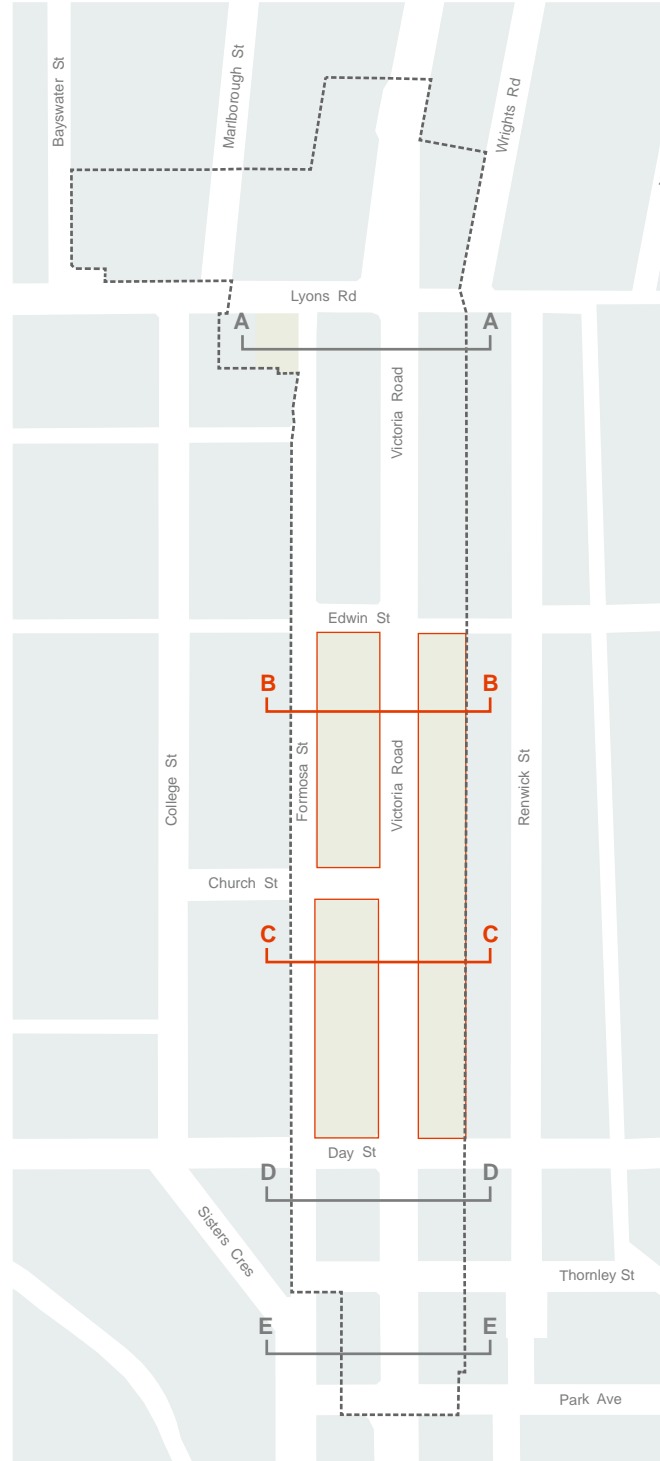
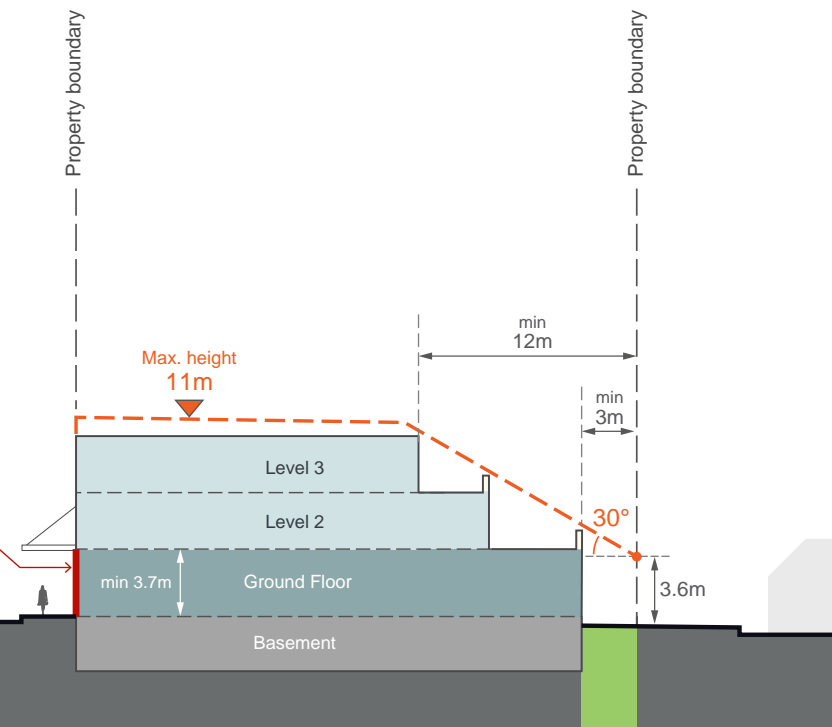
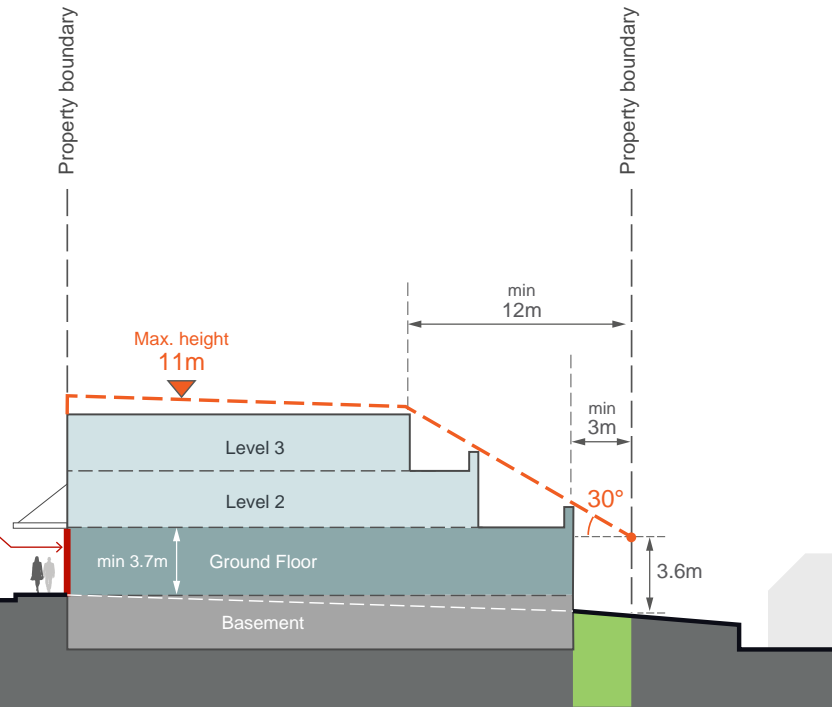

Fig G3.13 Built Form Envelope Section C



Key Plan Section B and C

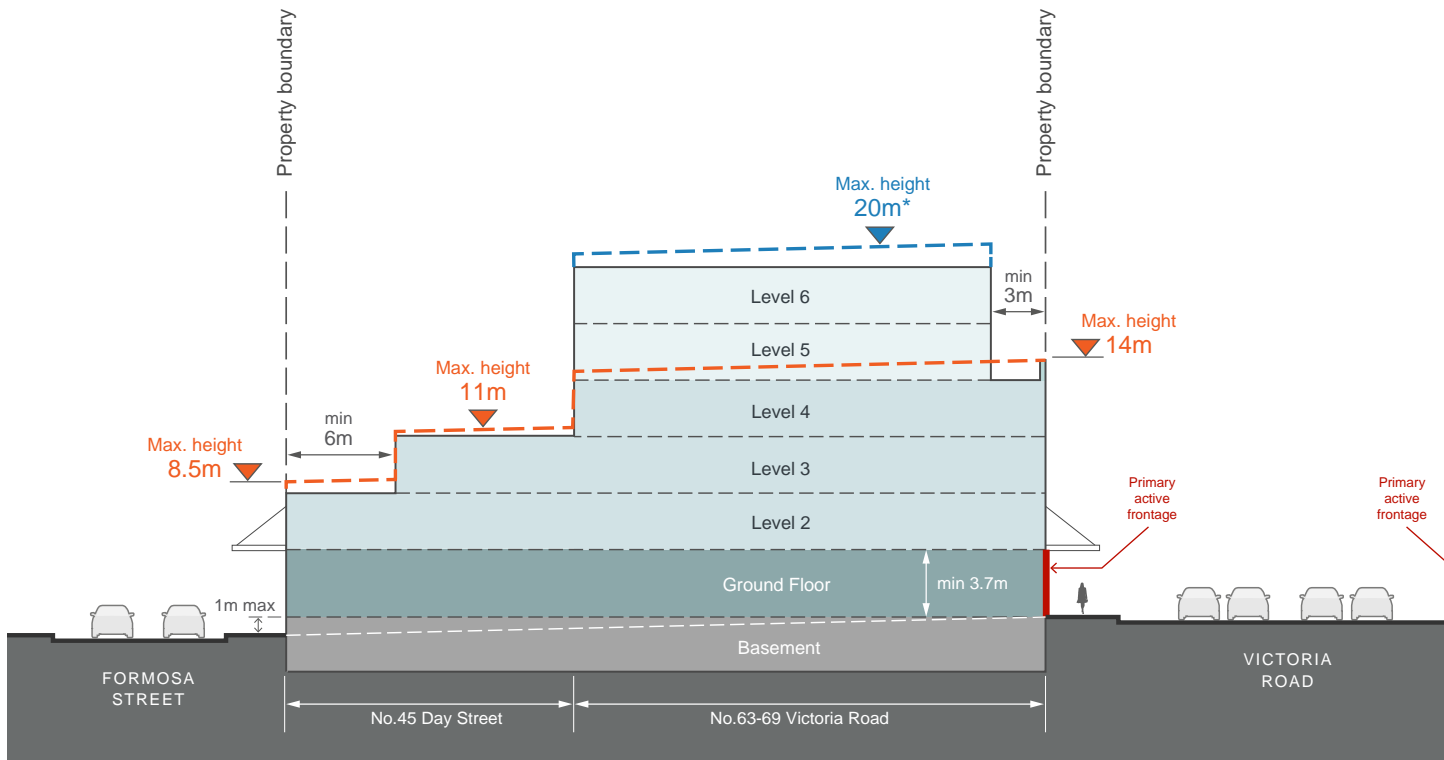

Fig G3.14 Built Form Envelope Section D

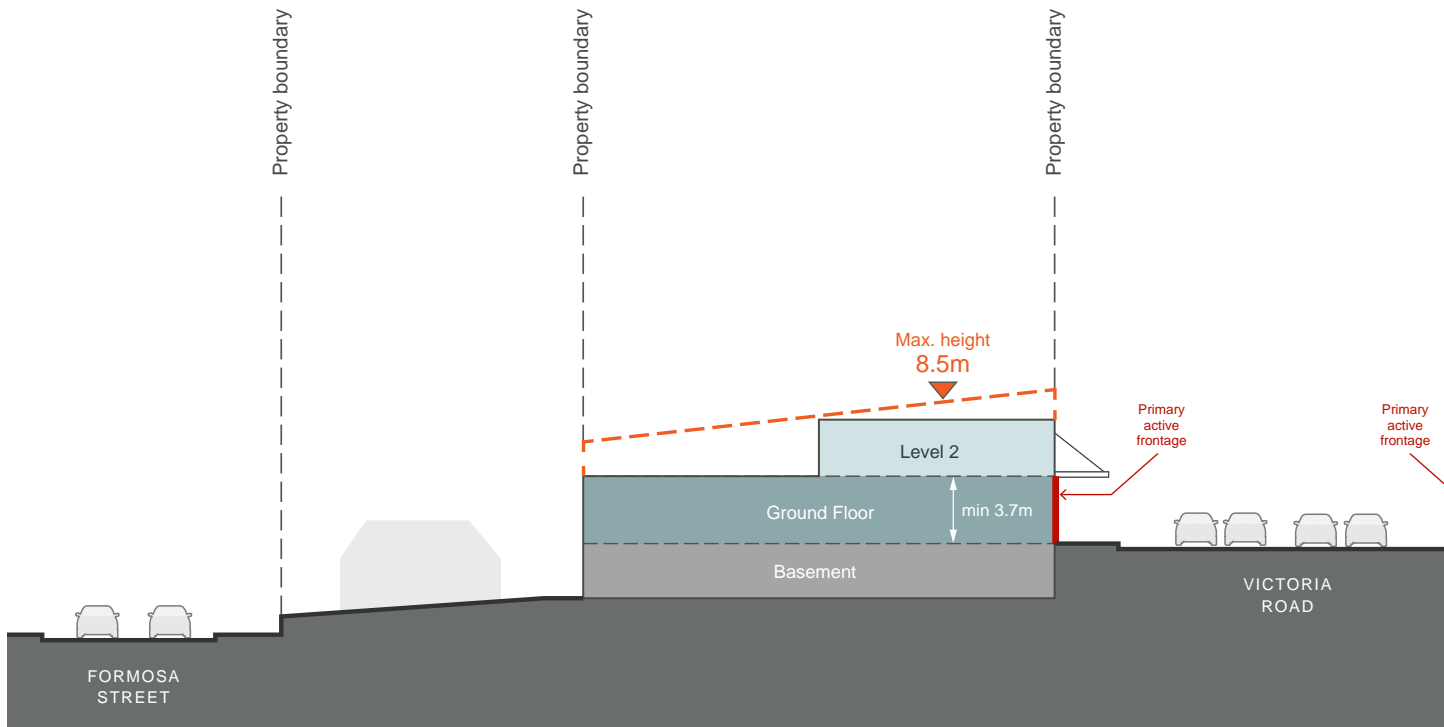
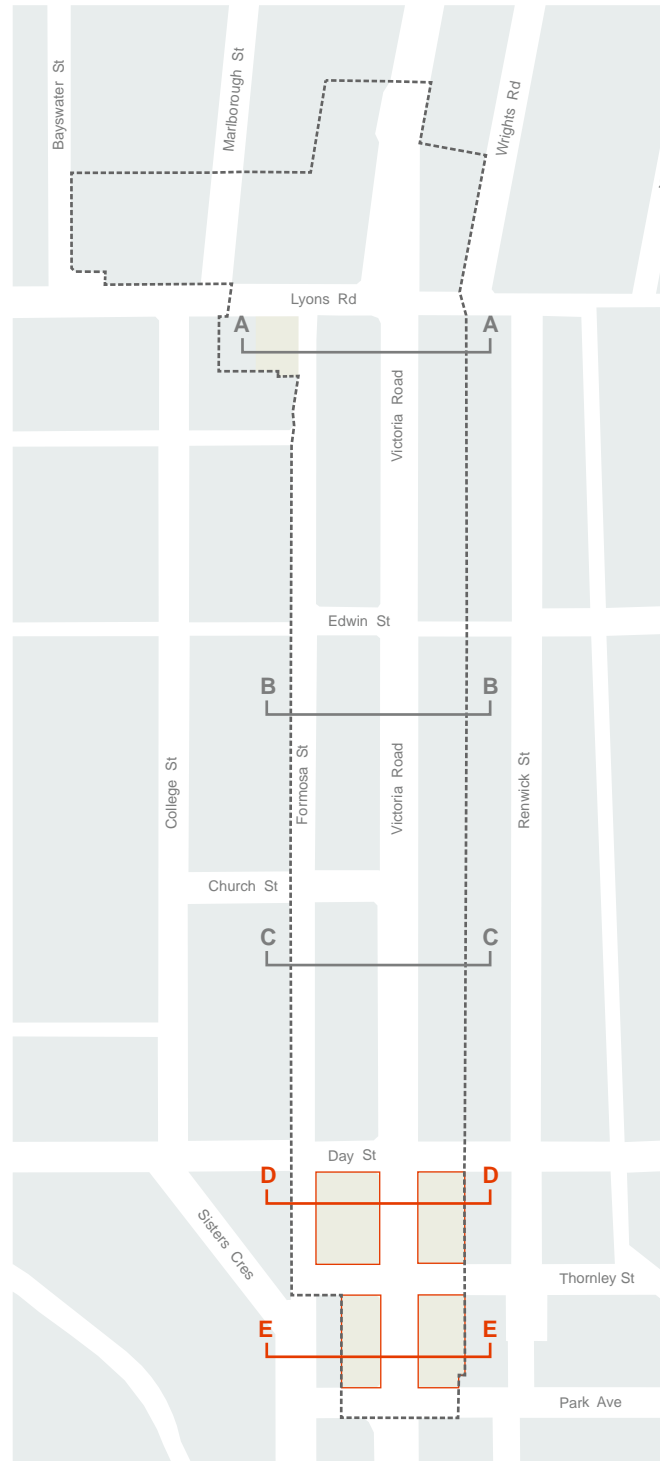
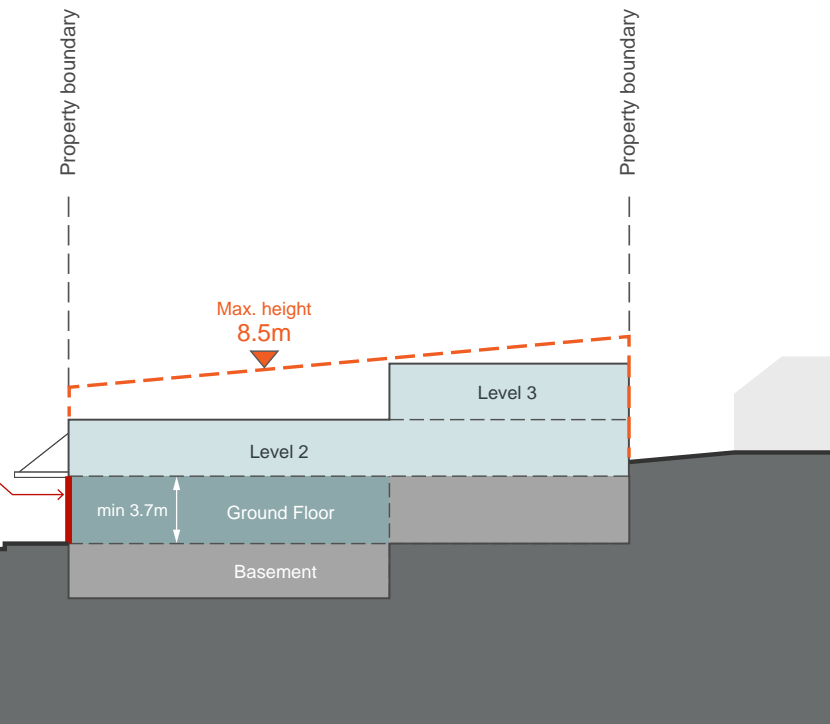
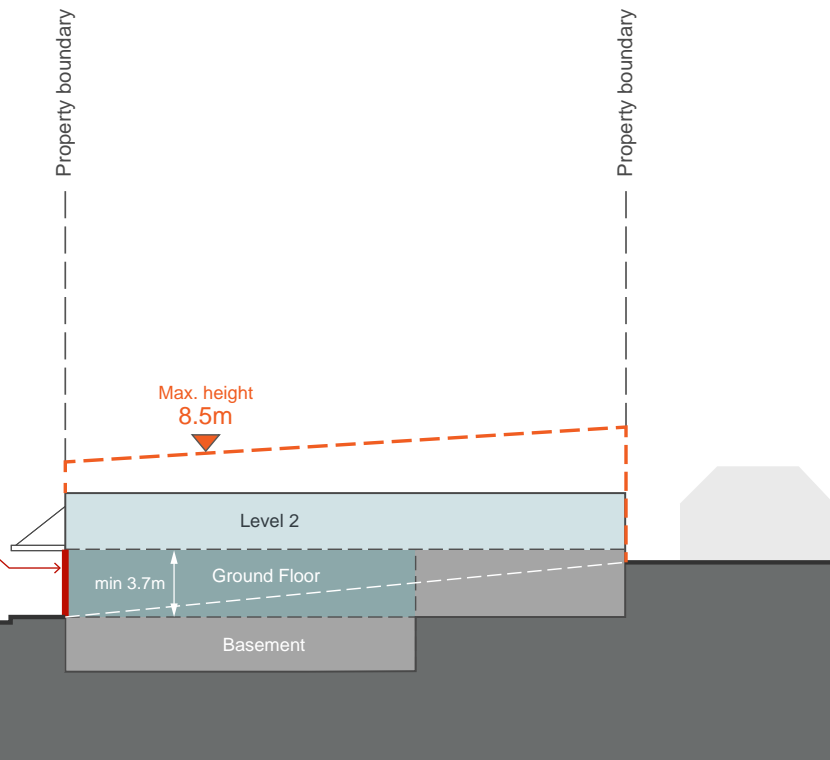

Fig G3.15 Built Form Envelope Section E



Key Plan Section D and E

## Special area: Sutton Place / Drummoyne Village



Fig G3.16 Sutton Place - Location Plan

### Objectives

- O1 Develop a compact, functional, and permeable urban structure, which is easily accessed from surrounding streets by vehicle and by foot.
- O2 To ensure efficient vehicular and pedestrian access links within and between Victoria Road, Lyons Road and Marlborough Street.
- O3 To achieve an appropriate built form for the role of the Drummoyne Village which also respects the surrounding heritage items and conservation areas.
- O4 To provide a mix of private open space and publicly accessible private open spaces.

### Access

| Controls |  |
|----------|--|
| C1.      | Retain existing pedestrian throughsite link between Marlborough Street and Victoria Road. Explore potential opportunity to widen this access way if future development occurs. |
| C2.      | Retain pedestrian access from Lyons Road into the courtyards through walkways and retail arcades.  |
| C3.      | Retain existing vehicular access to the Drummoyne Village site from Marlborough Street as far north as possible, away from major pedestrian movement paths.                    |
| C4.      | Vehicular access to the site from Victoria Road is discouraged.  |
| C5.      | Investigate changing Marlborough Street into a two-way street in order to improve access, slow traffic and promote a pedestrian friendly environment.                          |
| C6.      | Entrance to the commercial and residential uses will be provided wherever possible from the courtyards and walkways.   |

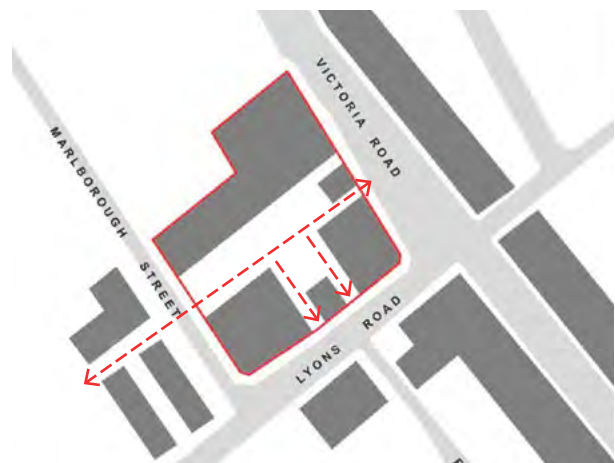

Fig G3.17 Permeable Village Strategy

**Uses**

| Controls |  |
|----------|--|
| C7.      | <p>The village site will provide a mix of uses through:</p> <ul style="list-style-type: none"> <li>• retail uses at ground level fronting onto Victoria Road, Lyons Road and existing and proposed courtyards;</li> <li>• generally commercial uses are to be provided on the second and third levels and;</li> <li>• residential uses are proposed on and above the third level.</li> </ul> |

**Built Form**

| Controls |  |
|----------|--|
| C8.      | The proposed built form is to be oriented to the street with a zero lot line to the street boundary; and enclose an open space within the interior of the block.   |
| C9.      | A height limit of 22m is required on the whole site to retain the scale of the Drummoyne skyline.  |
| C10.     | Development along Lyons Road and Victoria Road will maintain the parapet height of the Sutton Buildings as the height for their podium. The height of the podium is at 10.2m being two storeys in the Sutton Buildings and three storeys in all other buildings. |
| C11.     | Development fronting Marlborough Street will have a podium of 4 storeys setback 4.5 metres above a plinth at ground level which will form a street edge.   |
| C12.     | The setback to upper levels (5 and 6) from the Marlborough Street frontage is to be no less than 9.0m  |
| C13.     | Six storey heights will be provided at least 13.5m away from Lyons Road and other street boundaries to retain the scale and character of the street and the heritage buildings.  |
| C14.     | Built form is to be in accordance with Fig G3.23 to Fig G3.34.   |

**Outdoor Spaces**

| Controls |   |
|----------|---|
| C15.     | Sutton Buildings will maintain its existing courtyard. The courtyard should be increased in size by juxtaposing a similar shaped courtyard;                               |
| C16.     | Above ground communal open space should be provided for residential uses.   |
| C17.     | A gap should be provided in the development to the north of the space to allow the penetration of winter sun.   |
| C18.     | Outdoor eating is encouraged in areas fronting the courtyards and along the Marlborough Street walkway, generating activity in these courtyards.                          |
| C19.     | Restaurants and a possible outdoor eating terrace are encouraged at the northern end of the site to take advantage of the views to the west and the north western aspect. |

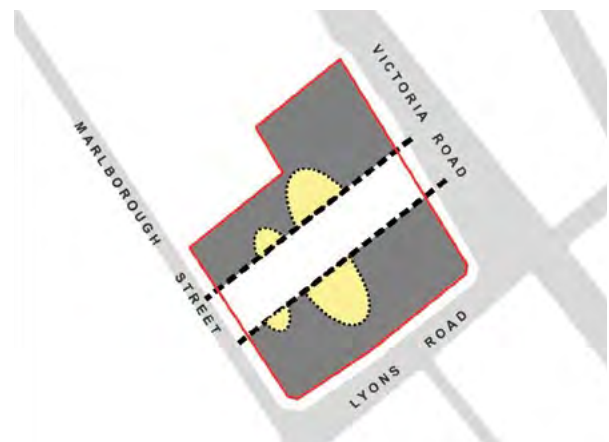

Fig G3.18 Interconnected Open Space Strategy



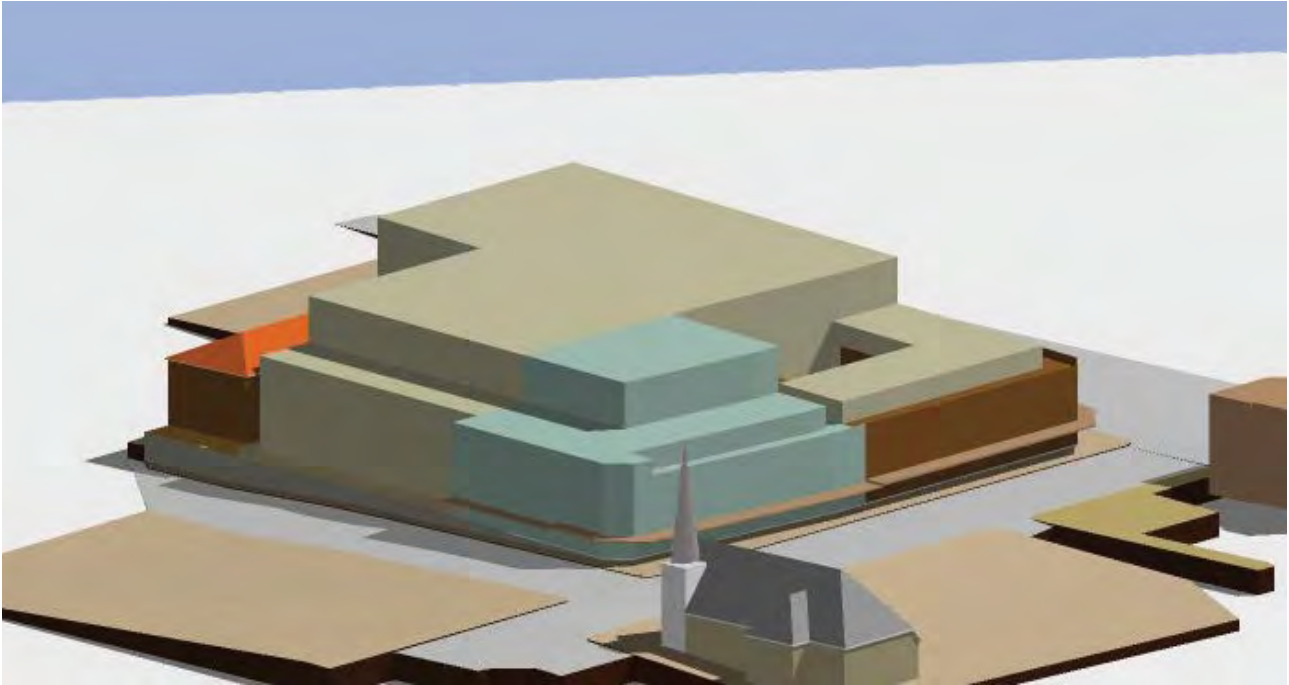

Fig G3.19 Heritage generated setback viewed from the south.

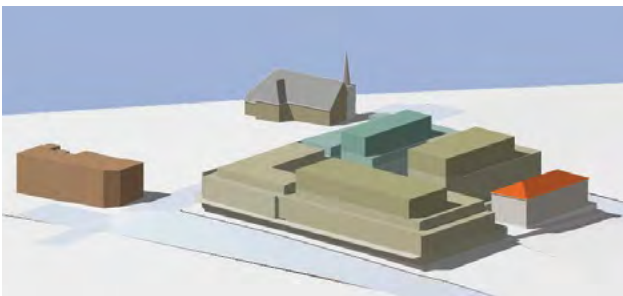

Fig G3.20 Potential building envelope view from north, incorporating heritage and amenity generated setbacks.

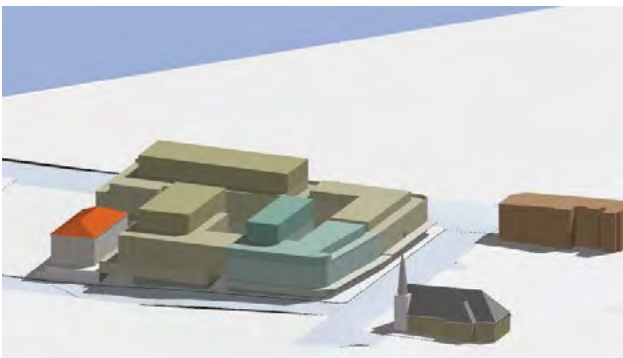

Fig G3.21 Potential building envelope view from south.



Fig G3.22 Potential building envelope top view of setbacks.

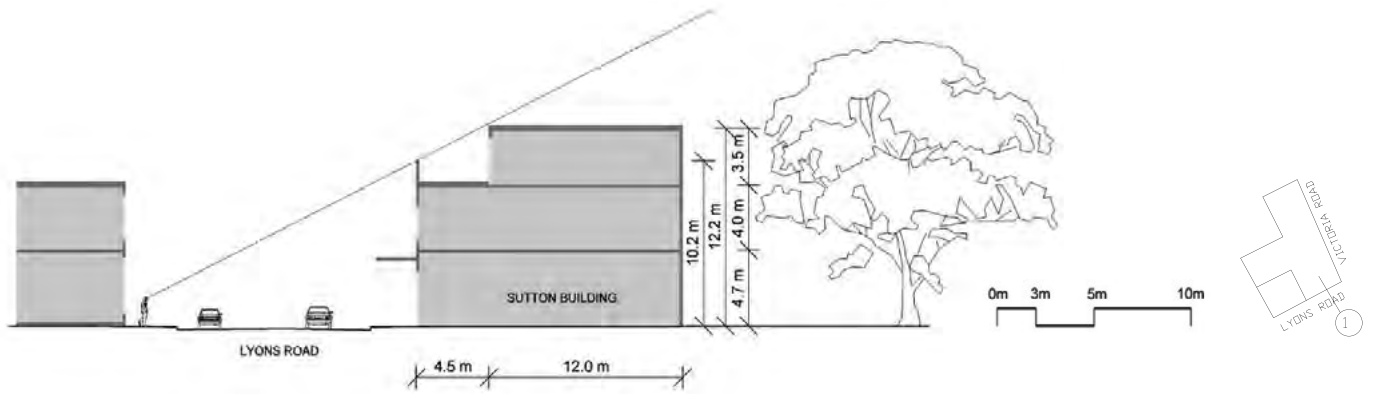

Fig G3.23 Heritage generated setback 1 through Sutton building.  
 Reducing the impact of development on the street character of Lyons Road and separating new built form from the existing.

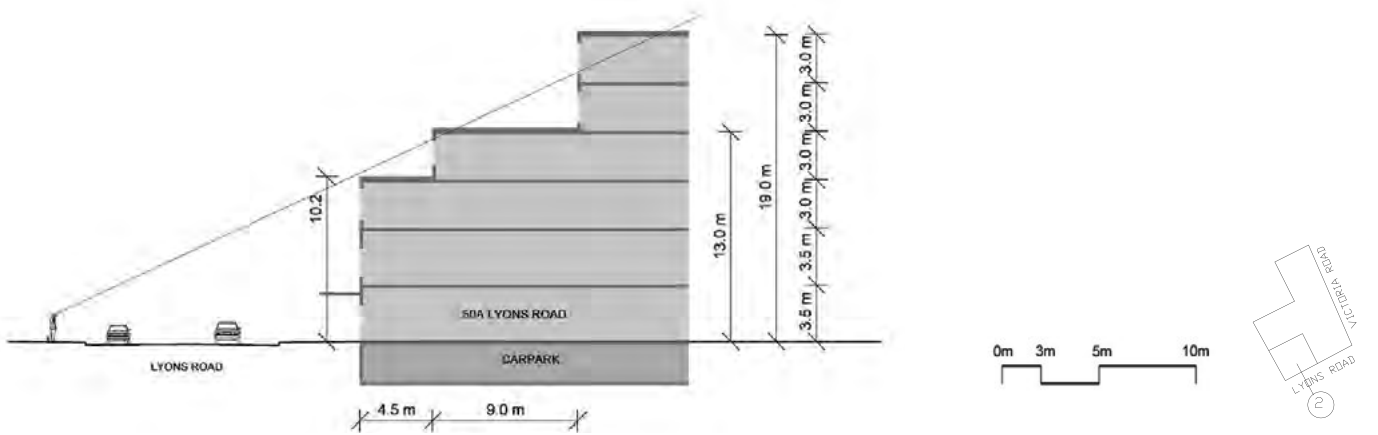

Fig G3.24 Heritage generated setback 2 through 50A Lyons Road.  
 Reducing the impact of development on the heritage items on this opposite side of the street. The parapet is compatible with the adjoining heritage item.

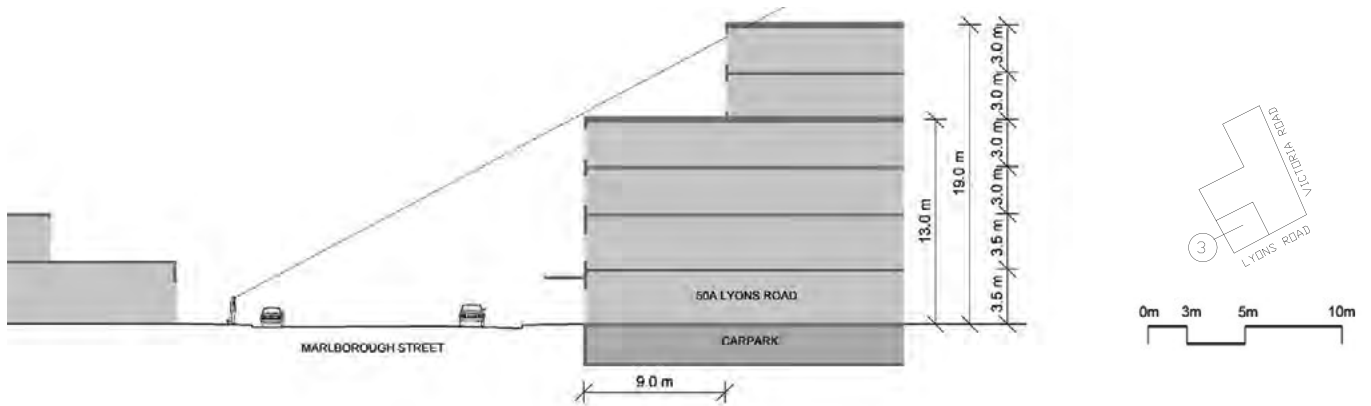

Fig G3.25 Heritage generated setback 3 through 50A Lyons Road on Marlborough Street. Reducing the impact of building bulk on heritage items to the east of Lyons Road.

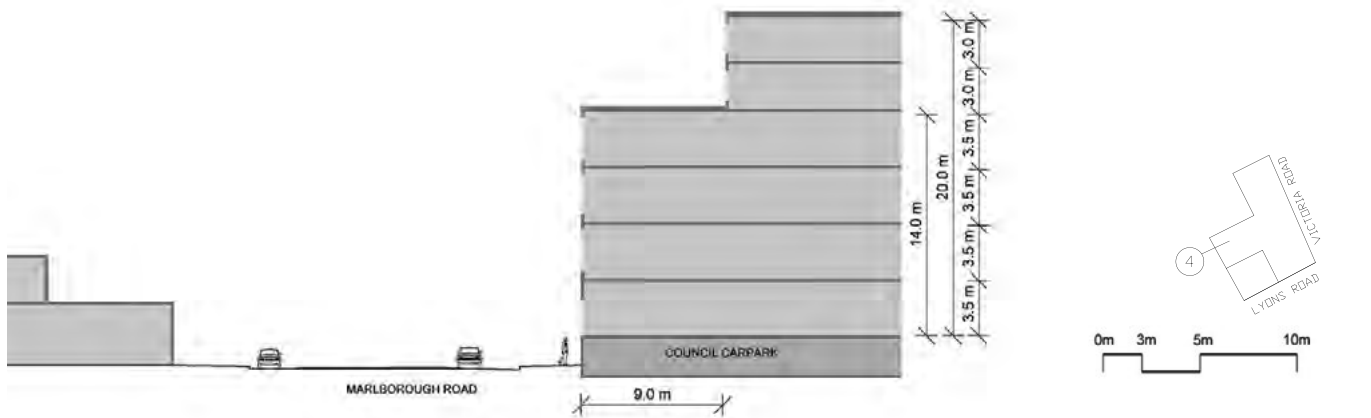

Fig G3.26 Heritage generated setback 4. Building form compatible with heritage item to the east of Lyons Road.

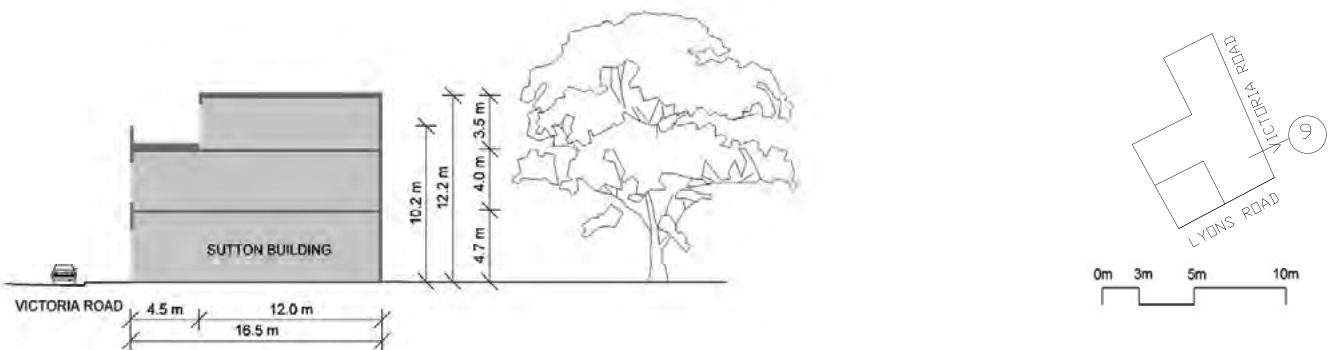

Fig G3.27 Heritage generated setback 9 through Sutton Building. Setback to separate new building from existing facade.

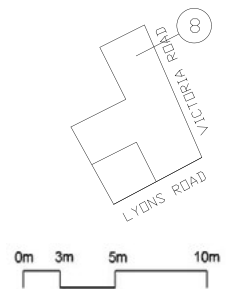
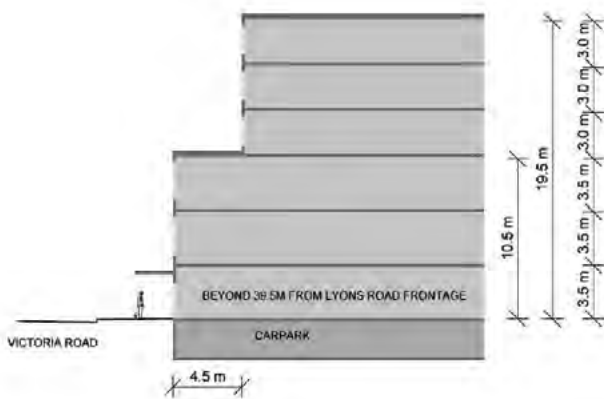

Fig G3.28 Heritage generated setback 8 through Victoria Road.  
Setback determined by height of Sutton Buildings' parapet.

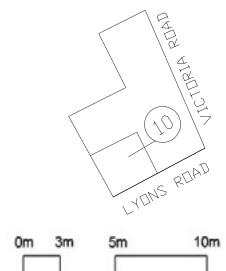
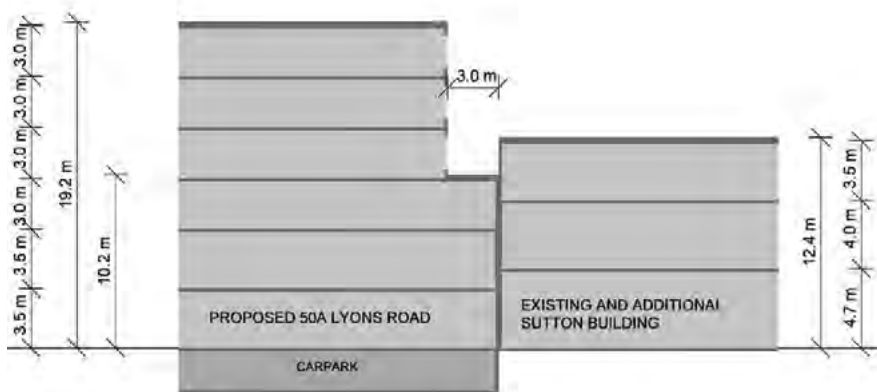

Fig G3.29 Heritage generated setback 10 through Sutton Building and 50A Lyons Road.

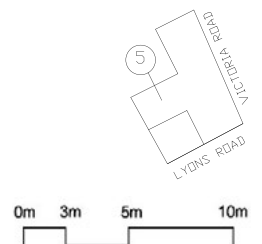
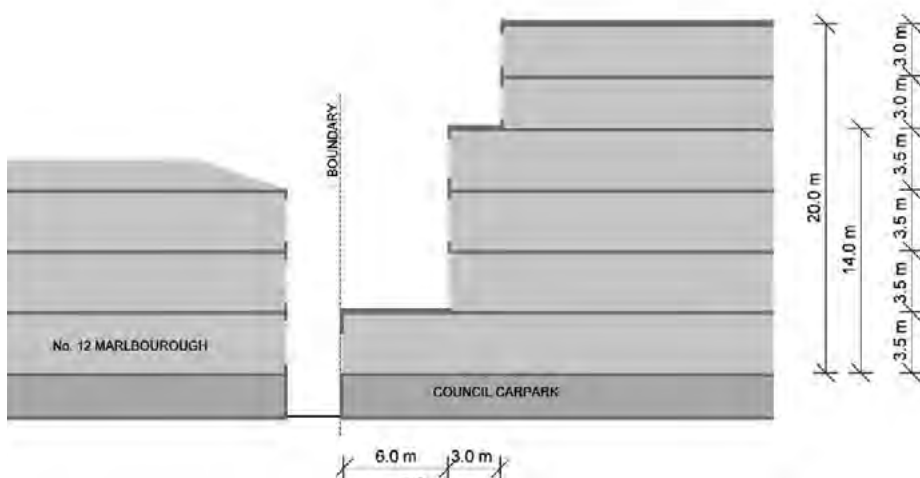

Fig G3.30 Amenity generated setback 5.  
The setbacks from the boundary are generated by amenity relating to the adjoining residential building.

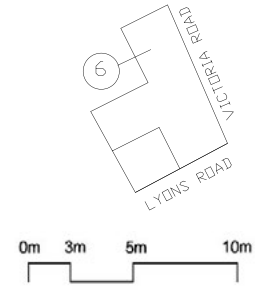
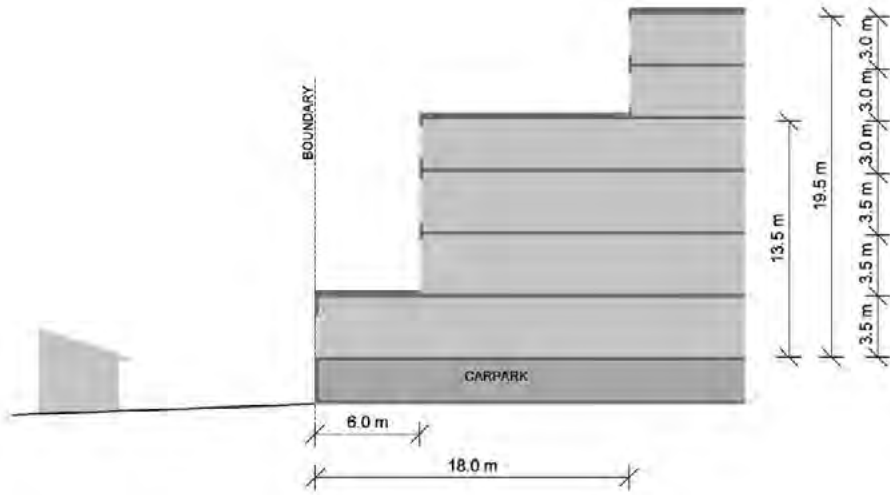

Fig G3.31 Amenity generated setback 6.  
 The setbacks from this boundary are generated by amenity relating to the adjoining residential building.

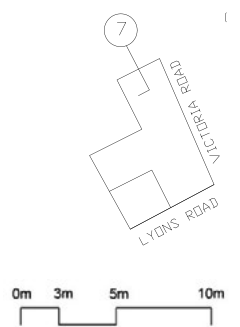
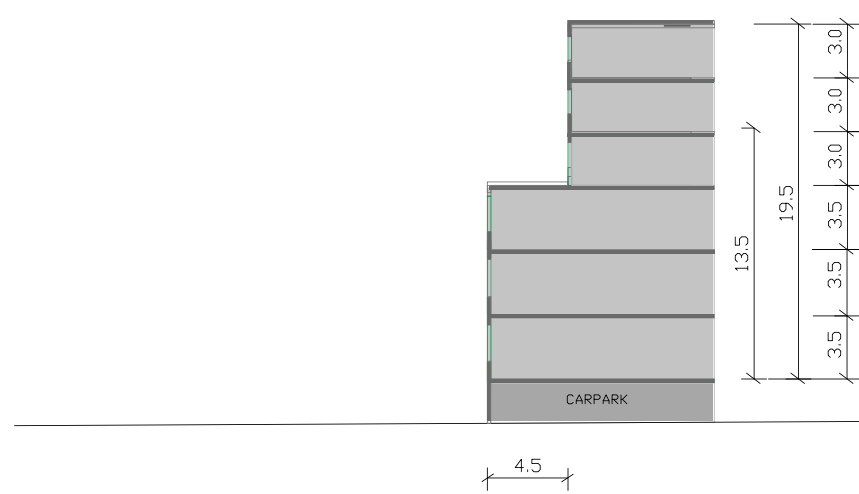

Fig G3.32 Amenity generated setback 7.  
 The setbacks from this boundary are generated by amenity relating to the adjoining residential building.

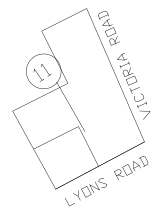
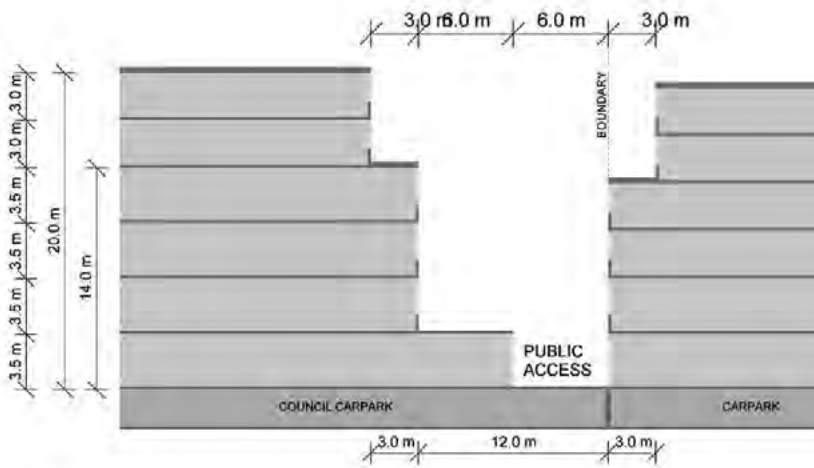

Fig G3.33 Amenity generated setback 10.  
Setbacks relating to SEPP 65 requirements for light and privacy and fire separation.

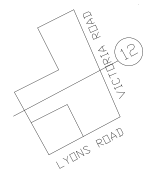
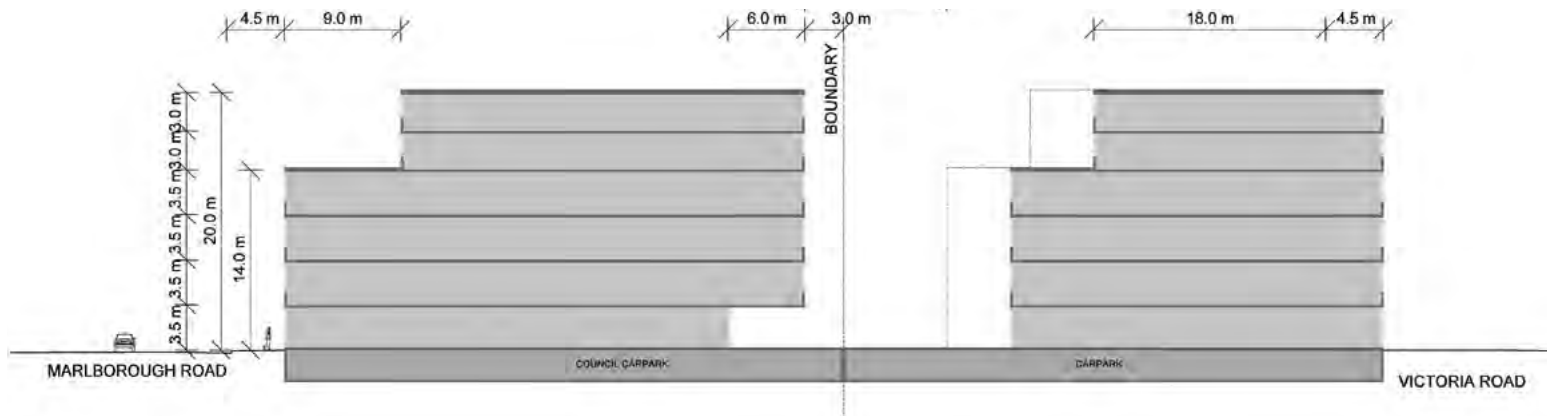

Fig G3.34 Heritage and Amenity generated setback 12.  
Envelope generated by desire for public space within development.



## Special area: 53 – 69 Victoria Road, 45 Day Street and 46 Thornley Street, Drummoyne Planning Proposal



Fig G3.35 53 – 69 Victoria Road, 45 Day Street and 46 Thornley Street, Drummoyne Planning Proposal Location Plan

### General objectives

- O1 To allow redevelopment with higher densities along Victoria Road while at the same time minimising the solar, visual and privacy impacts on surrounding properties.
- O2 To allow development that effectively transitions from taller heights at the northern corner of the site (corner of Day Street and Victoria Road) down to lower scale development to the south, east and west of the site (along Formosa Street and Thornley Street).

### Height of Building

New buildings are to have a scale that is visually compatible with surrounding development. The height of new development is to reduce towards the south and west and to achieve a successful transition it may need to be lower than the maximum height permitted in the LEP along Formosa Street and Thornley Street.

- O3 To concentrate higher development in the northern corner of the block, at Victoria Road and Day Street.
- O4 To provide an effective transition to the surrounding two storey development to the west and south by locating two to three storey built form along the street wall of the block.
- O5 To maximise the solar access and minimise the visual and privacy impacts on surrounding properties.
- O6 To create attractive streets along all boundaries of the block.

### Controls

|     |   |
|-----|---|
| C1. | Maximum building height along the Victoria Road alignment is 4 storeys with a minimum 3 metre set back from Victoria Road and Day Street to any 5 or 6 storey component of the development.                               |
| C2. | Maximum building height at the Formosa Street and Thornley Street alignment is 2 storeys with a minimum 6 metre set back to any 3 storey component of the development.  |
| C3. | 2 and 3 storey development within the 11m height limit is to be in accordance with the building envelope in <b>Fig G3.36</b> to <b>Fig G3.42</b> .  |
| C4. | The roof form at both Victoria Road and Formosa Street is to be a parapet edge.   |
| C5. | Basement garaging is to be designed to minimise the bulk and scale of the development, minimising blank walls to the street. Garage structures are not to extend more than 1m above the natural ground line at any point. |
| C6. | All plant must be contained within the building envelope.   |

## Bulk and Scale

The bulk and scale of a development plays an important role in helping the development fit into its surrounding context and minimise the impacts of development.

- O7 To accommodate a two to three storey built form along the southern and eastern boundaries of the block.
- O8 To provide height controls that accommodate the steep topography in the southern corner of the block.

### Controls

|      |  |
|------|--|
| C7.  | Basement parking is not to extrude more than 1m above the natural ground line.   |
| C8.  | Development along Formosa Street and Thornley Street is to have a two storey appearance.   |
| C9.  | It may be possible to provide some four storey development within the site at 53 Victoria Road where this can occur entirely within the maximum building envelope, is set back a minimum of 3 metres from the 3 storey street wall along Victoria Road and where it does not increase overshadowing or reduce privacy of adjoining properties. |
| C10. | The design of balconies and roof terraces is to minimise the visual bulk of the building. This is particularly important along Formosa Street and Thornley Street.   |

## Active frontages









Active frontages contribute to visual and physical activity along the street particularly along Victoria Road and may include community and civic facilities, recreation and leisure facilities and shops, restaurants and cafes.

- O9 To promote activity and interest along Victoria Road and at the highly visible corners.
- O10 To enhance the commercial viability and compliment existing retail, commercial, entertainment and community uses.
- O11 To enhance safety and security in the area.

### Controls

|      |   |
|------|---|
| C11. | Provide ground level active uses and a continuous cantilevered awning where indicated in <b>Fig G3.36</b> .   |
| C12. | Ground level active uses are to be a minimum of 10m deep and have a finished floor level no greater than 0.4m above or below the footpath level.            |
| C13. | Residential entries and foyers are permitted along ground level active street frontages but are not to compromise the commercial activity along the street. |
| C14. | Vehicle access points are not permitted in areas indicated as active street frontage.   |



-  20m\* max. building height (6 storeys)
-  Area where an increase to a maximum building height of 20m on sites greater than 2,500sqm may be possible
-  14m max. building height (3 storeys)
-  11m max. building height (3 storeys)
-  8.5m max. building height (2 storeys)
-  6m minimum upper level setback to boundary
-  3m minimum upper level setback to boundary
-  Active street front & continuous awning required

\* Increased heights only applicable if total development site area over 2,500sqm

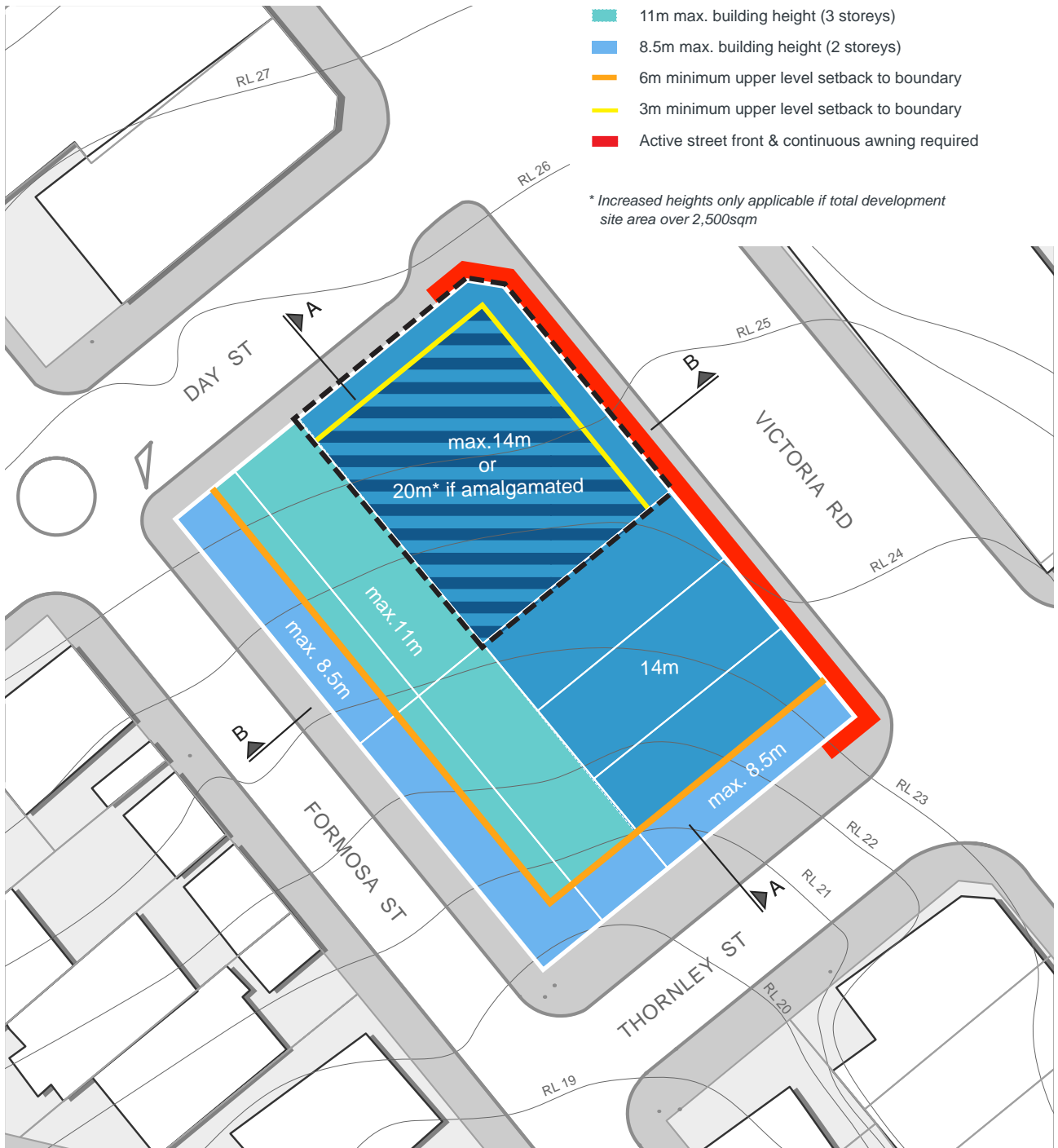

Fig G3.36 Area 'H' development controls plan



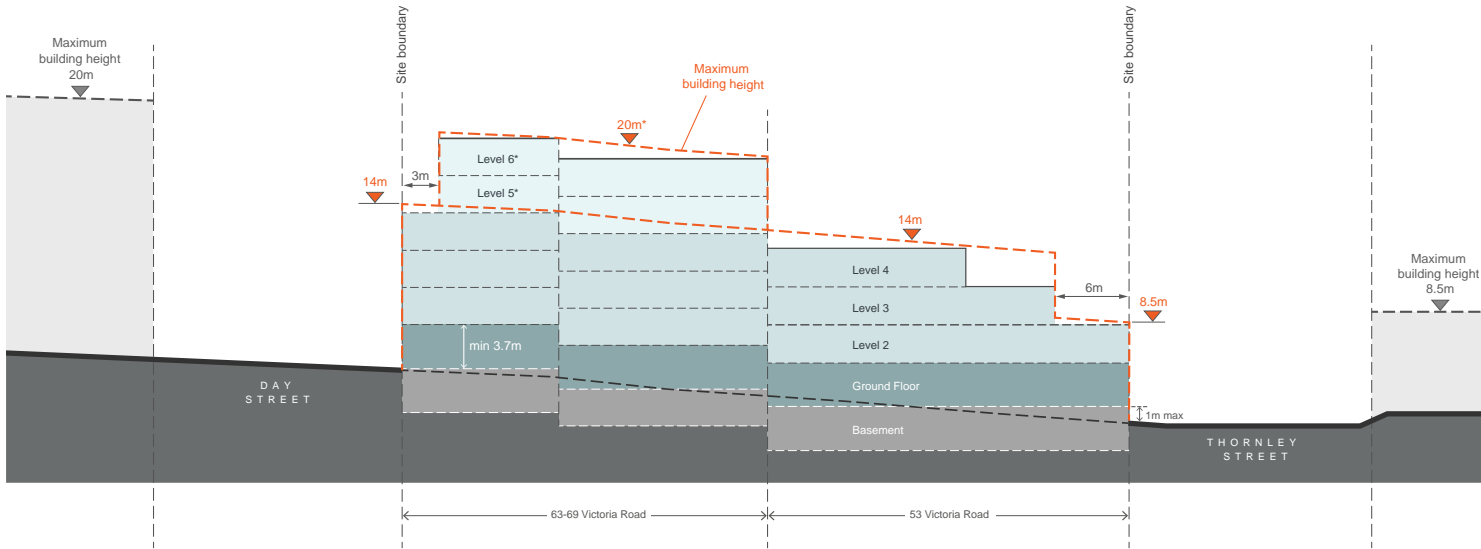

Fig G3.37 Area 'H' Section A

\* Increased heights only applicable if total development site area over 2,500sqm

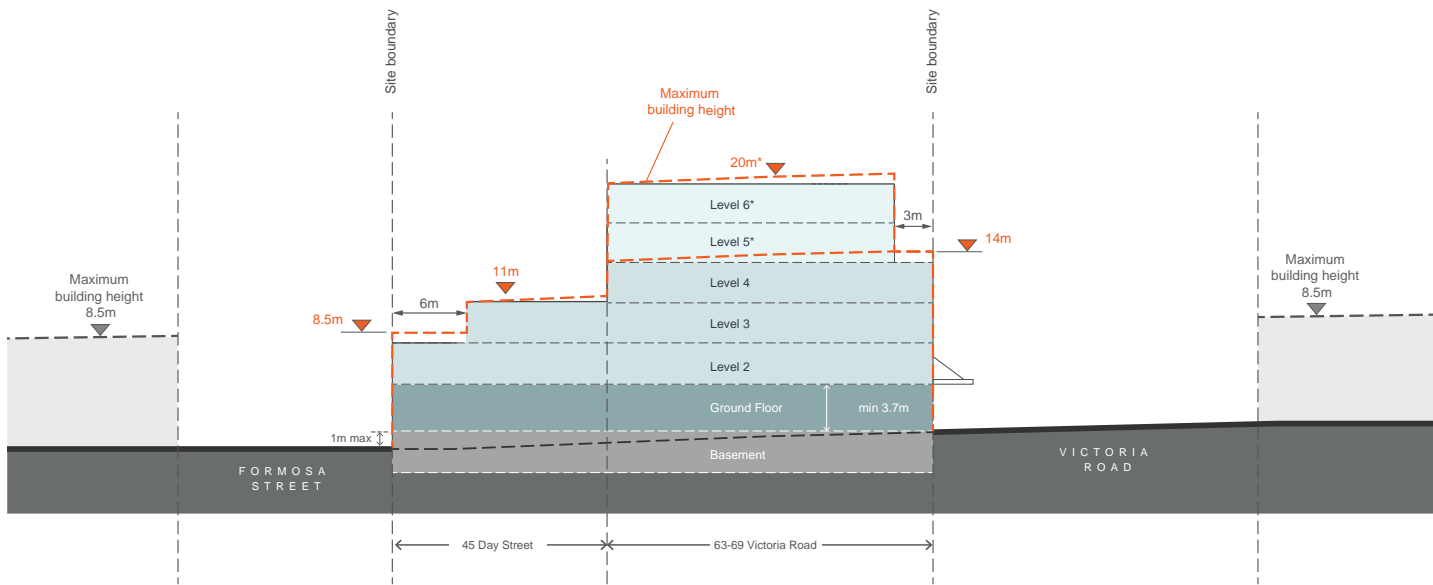

Fig G3.38 Area 'H' Section B

\* Increased heights only applicable if total development site area over 2,500sqm

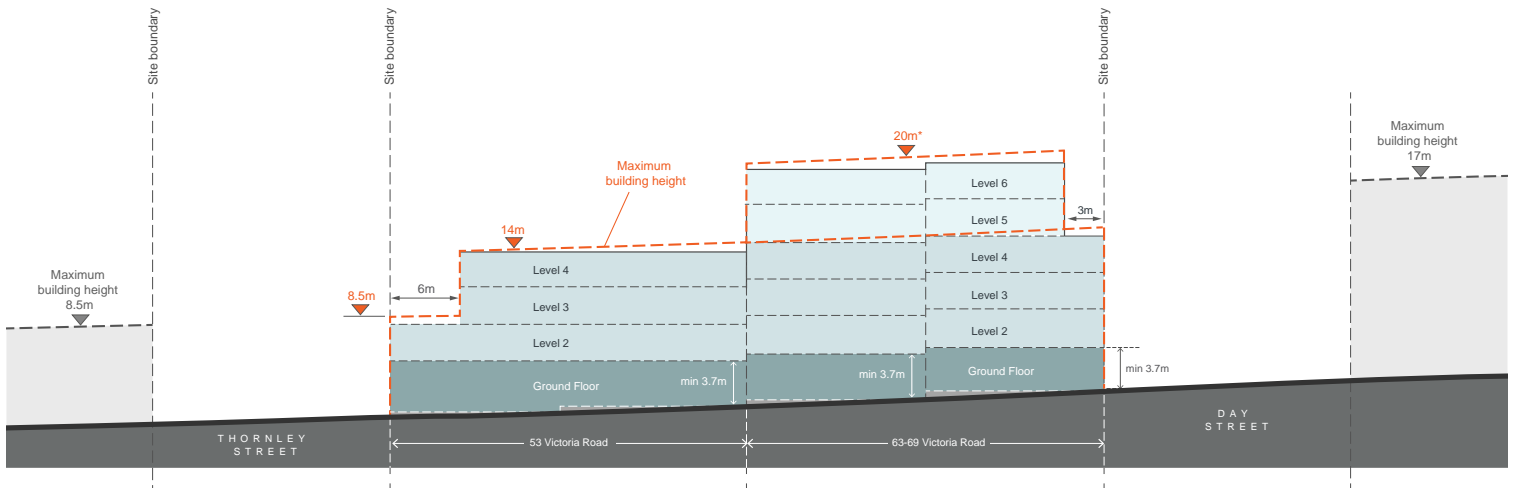

Fig G3.39 Area 'H' Elevation 1 Victoria Road

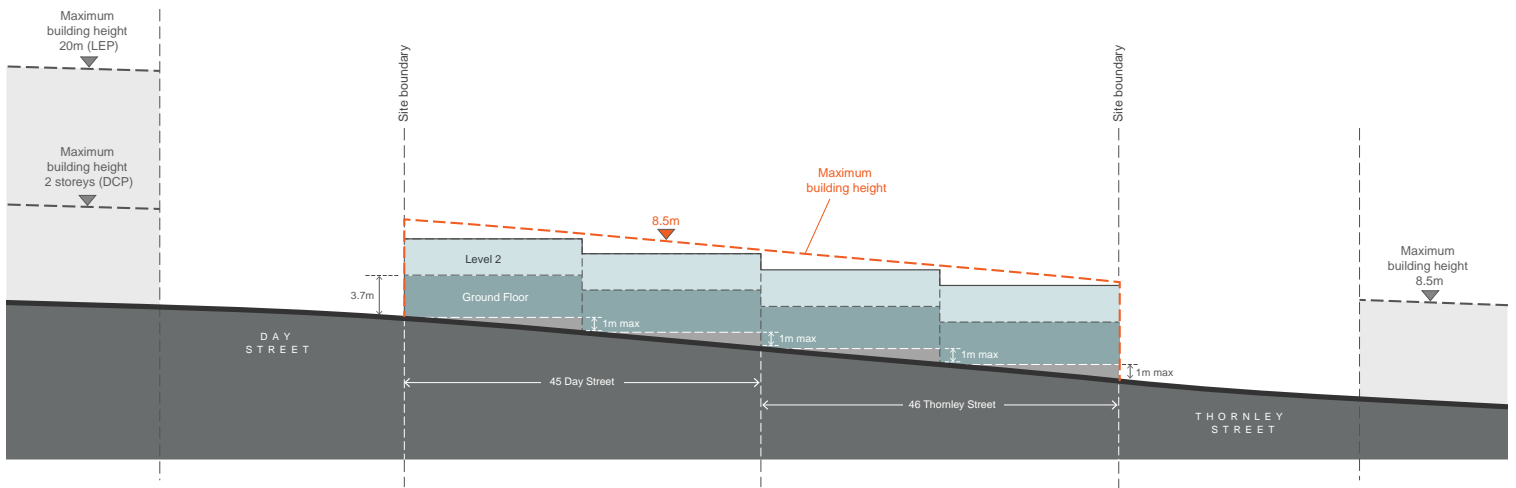

Fig G3.40 Area 'H' Elevation 2 Formosa Street

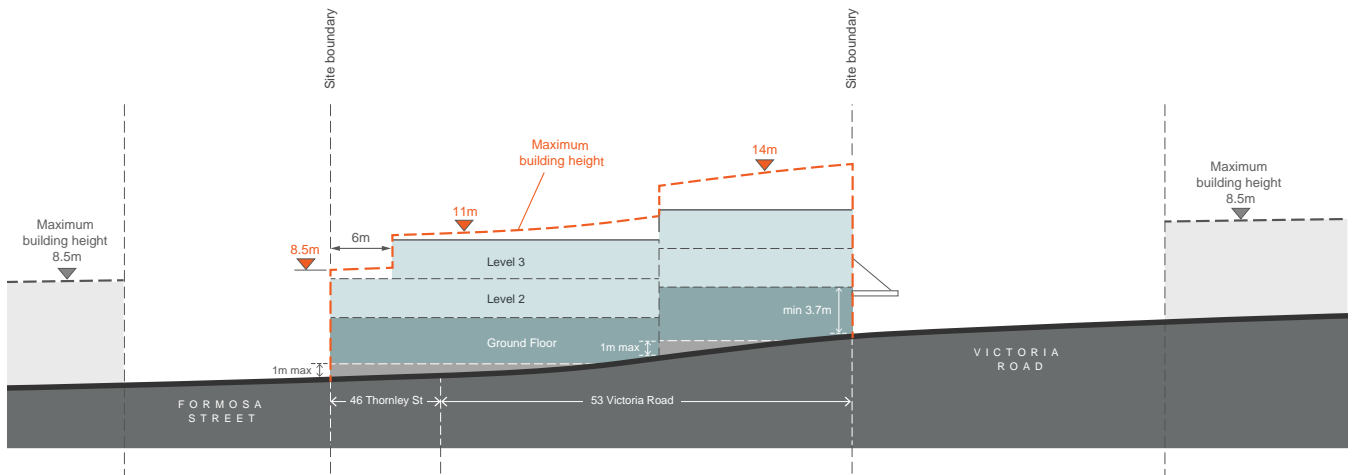

Fig G3.41 Area 'H' Elevation 3 Thornley Street

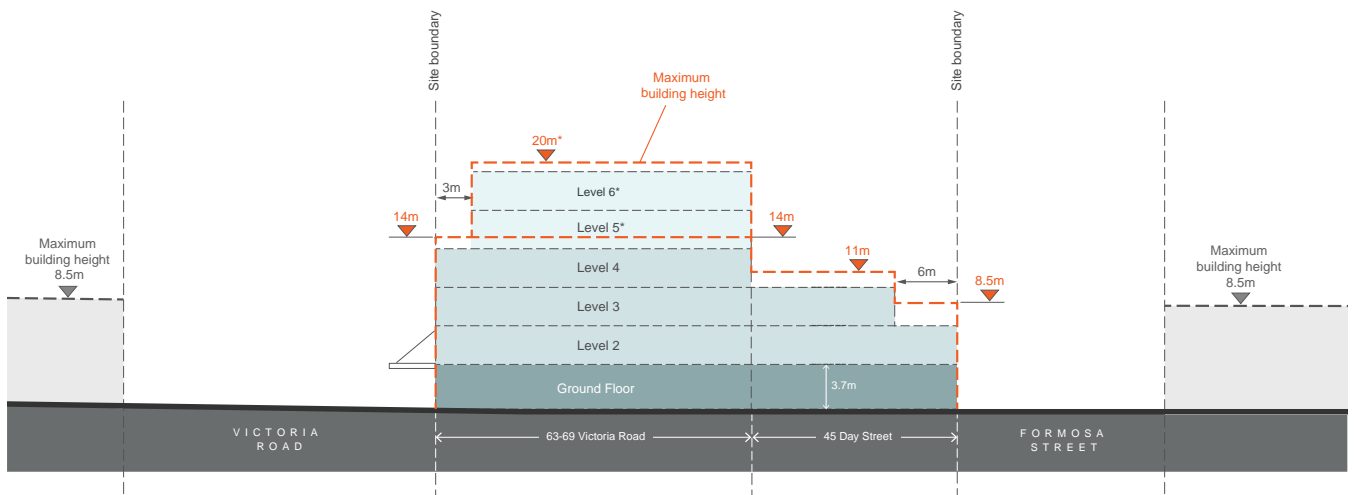
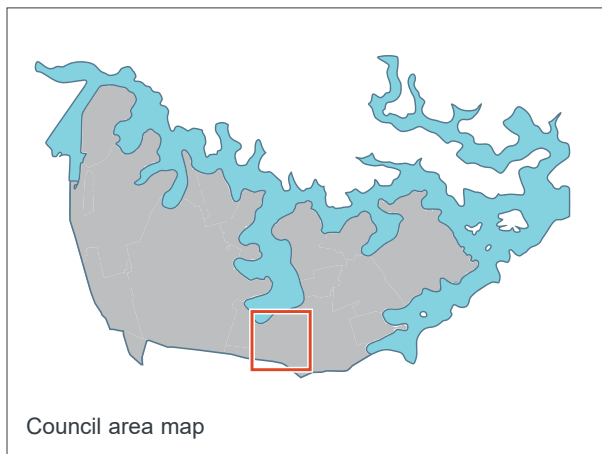

Fig G3.42 Area 'H' Elevation 4 Day Street

\* Increased heights only applicable if total development site area over 2,500sqm

## G3.2 Five Dock Town Centre



### Context

The Five Dock Town Centre is focused along each side of Great North Road between Queens Road and Fairlight Street to the south and Lyons Road to the north. The centre is a commercial, civic, community and residential precinct, with a local neighbourhood emphasis and consists primarily of 2-3 storey buildings.

Variety is created along the streetscape through different building styles which range from Edwardian and inter-war buildings to more recent development including a mixed use building on Garfield Street, which incorporates the Five Dock public library.

The centre starts in the south at the ridge line intersection at Fairlight/Queens Road with Great North Road and extends along Great North Road past First Avenue and Garfield Street with the northern end defined by intersection with the Lyons Road/Lyons Road West. The highest part of the centre occurs to the south of the centre between Kings Road and Second Avenue.

Taller buildings have views to the Sydney CBD and the Sydney Harbour Bridge to the north-east, Hen and Chicken Bay to the north-west and the Blue Mountains to the west. Land use zoning allows mixed use activities, including apartments with retail uses located on the ground floor, along Great North Road.

### Land to which this DCP applies

This Part applies to all land shown within the area identified in 'Fig G3.43 Location Plan'.

### Desired future character

The Five Dock Town Centre will be a place where new buildings, alterations and additions contribute to the local 'village character' and heritage values through appropriate building forms, setbacks and heights.

Development proposals in the centre are required to provide a written statement that outlines how the following future character performance criteria have been achieved:

- **Mixed use:** New developments and alterations add to the centre's function as a vibrant destination for the local community and visitors, by providing a diverse mix of uses including retail, hospitality, residential and recreational facilities.
- **Well-proportioned streetscapes:** The bulk and scale of new development and alterations ensures good access to sunlight and natural ventilation is retained along the centre's streets and to areas of public open space. Built form will also create consistent street wall heights, especially along Great North Road, and ensure the bulk and scale steps down towards adjoining residential areas.
- **Quality built form:** New buildings and alterations display a high level of architectural design quality with construction methods and materials that are proven to be durable over time, colours that integrate with the context and building articulation that is sympathetic with adjoining built form and the local 'village character'.
- **Safety and surveillance:** New buildings and alterations support street level activity by paying particular attention to the design of ground floors, facades, signage and awnings and by providing opportunities for passive surveillance of the public domain from upper levels.
- **Access and mobility:** New development supports accessibility of the centre by reinforcing, and where possible adding to, a permeable and attractive network of streets, lanes, footpaths and pedestrian links.

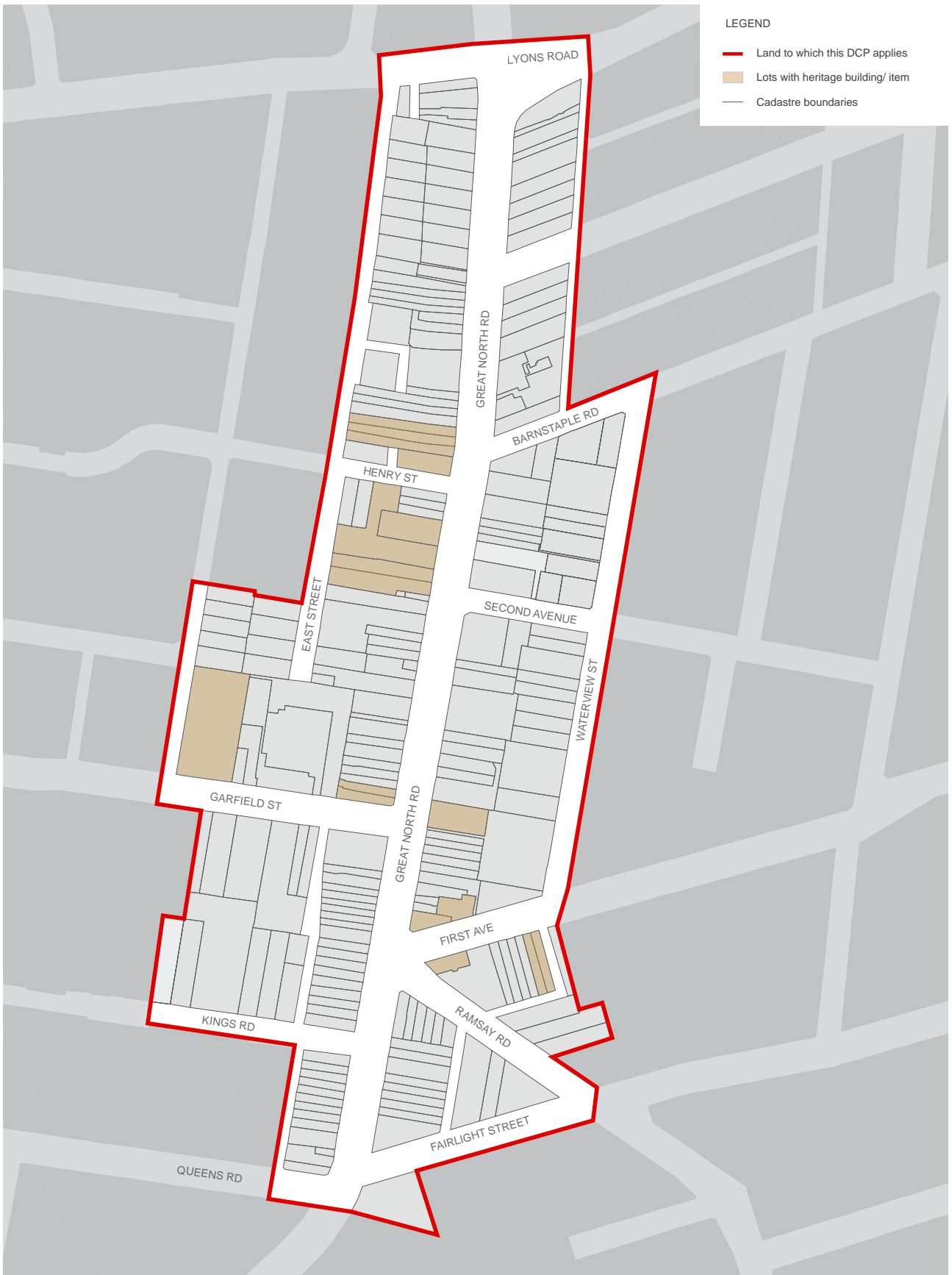
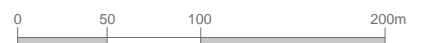

Fig G3.43 Location Plan



## Public open space

### Objectives

- O1. To increase the amount of open space in the centre and to provide more areas for the community to meet, gather and relax.
- O2. To ensure areas of open space have access to adequate sunlight especially in mid-winter between 12-2pm.
- O3. To ensure new areas of open space are of a sufficient size to accommodate a wide variety of activities.

### Controls

|     |   |
|-----|---|
| C1. | Provide a Northern Gateway Plaza on the corner of Lyons Road and Great North Road (identified as Public Open Space A in 'Fig G3.45 Public Domain').           |
| C2. | Widen Fred Kelly Place to the north (identified as Public Open Space B in 'Fig G3.45 Public Domain').   |
| C3. | Provide a new town square on the eastern side of Great North Road opposite Fred Kelly Place (identified as Public Open Space C in 'Fig G3.45 Public Domain'). |

## New laneways

### Objectives

- O4. To improve east west access and connectivity, making it easier and more attractive to cycle and walk through the centre.
- O5. To attract people to the new town square and create a pleasant safe environment around the square.
- O6. To facilitate car parking exits and entries for buildings fronting Great North Road.
- O7. To provide the opportunity to service businesses on Great North Road and limit service vehicle movements along residential streets, e.g. along Waterview Street.
- O8. To improve existing and create new connections between the Five Dock Public School (West Street) and Great North Road.

### Controls

|     |   |
|-----|---|
| C4. | Provide a network of new laneways in the block bounded by First Avenue, Second Avenue, Waterview Street and Great North Road. |
|-----|---|

|     |  |
|-----|--|
| C5. | Provide a new laneway between East Street and West Street along the alignment of Lancelot Street.  |
| C6. | Provide a new laneway between Barnstaple Road and Second Avenue.   |
| C7. | All laneways are to be a minimum of six (6) to nine (9) metres wide. Where a laneway is less than nine (9) metres, the design of the laneway must demonstrate how vehicular and pedestrian traffic can be managed to avoid conflicts and safety issues.                      |
| C8. | New development between Barnstaple Road and Second Avenue is not permitted to provide vehicular access and servicing off Great North Road, Waterview Street, Barnstaple Road or Second Avenue. All vehicular access and servicing must be provided off the proposed laneway. |

## Pedestrian connections

### Objectives

- O9. To improve east-west access, making it easier to cycle and walk through the centre.
- O10. To create new access routes that support pedestrian activity along Great North Road.

### Controls

|      |   |
|------|---|
| C9.  | Provide a new mid-block link between Great North Road and East Street within the hatched area identified in 'Fig G3.44 Access Network and Hierarchy'. |
| C10. | Provide a new mid-block link between Garfield Street and Kings Road within the hatched area identified in 'Fig G3.44 Access Network and Hierarchy'.   |
| C11. | Widen the existing pedestrian link to the east of Great North Road opposite Garfield Street.  |
| C12. | All pedestrian links are to be a minimum of four (4) metres wide.   |
| C13. | All links are to be activated by retail, civic and/or commercial uses.  |
| C14. | All links are to be naturally lit and ventilated, and well-lit after hours.   |
| C15. | All links are to be publicly accessible between at least 6am and 8pm daily, however 24-hour public access is preferred.                               |
| C16. | All links are to follow Safer-by-Design (or CPTED) principles (i.e. clear lines of sight).  |



- LEGEND**
- █ State-owned road (RMS)
  - █ Local street - collector
  - █ Local street - access
  - █ Laneway / pedestrian link
  - ▨ Laneway (strata)
  - ▨ Proposed laneway (preferred location, 6-9m wide)
  - ▨ Proposed pedestrian link (preferred location, min 4m wide)
  - █ Open space
  - █ Proposed open space
  - Five Dock Town Centre boundary

*Note: New and expanded areas of public open space have been identified in this plan. It is expected that some of these areas will be delivered by Council and/or as part of the redevelopment of adjacent properties.*

Fig G3.44 Access Network and Hierarchy





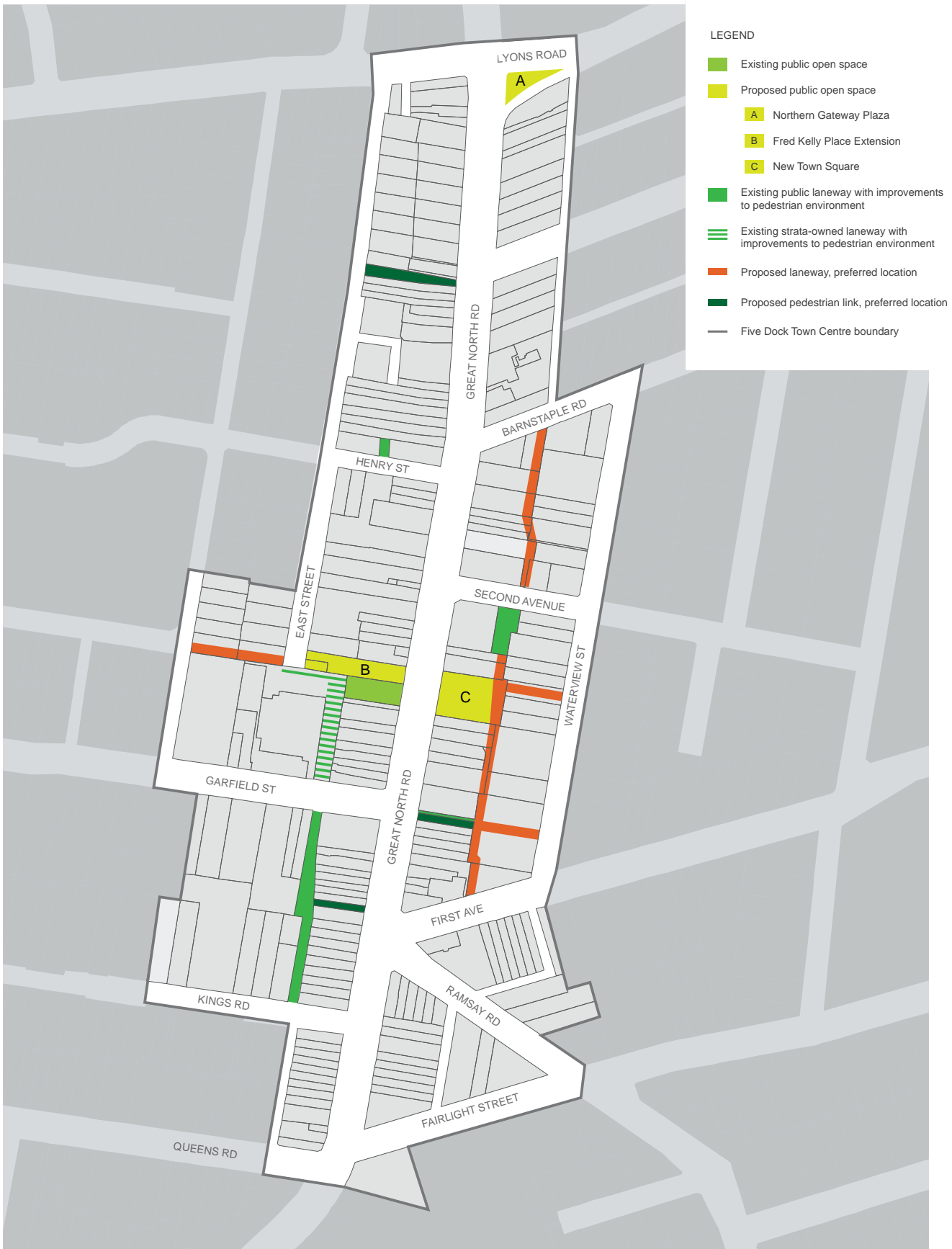

LEGEND

- Existing public open space
- Proposed public open space
- A Northern Gateway Plaza
- B Fred Kelly Place Extension
- C New Town Square
- Existing public laneway with improvements to pedestrian environment
- Existing strata-owned laneway with improvements to pedestrian environment
- Proposed laneway, preferred location
- Proposed pedestrian link, preferred location
- Five Dock Town Centre boundary

Fig G3.45 Public Domain

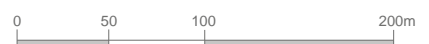

## Built Form

The built form controls shape the form of new development in the centre, establishing the location, height and shape of new buildings. The controls also consider visual privacy, sunlight access to adjoining properties, usability of private open spaces and pedestrian scale and amenity along the street.

### Objectives

- O11. To encourage investment in the town centre and create attractive places to live, shop and recreate.
- O12. To ensure adequate sunlight is available for all buildings, streets and public open spaces.
- O13. To promote opportunities for catalyst and landmark developments in appropriate locations.
- O14. To ensure the ground floor levels along key streets are appropriate for retail uses and that ground level uses in the remaining streets are adaptable over time to a wide range of uses.
- O15. To ensure the urban grain, built form and palette of materials used in the design of new buildings respond to the “fine grain” character of the surrounding area.
- O16. To minimise the visual impact of above ground car parking and encourage car parking that is adaptable to other uses in the future.
- O17. To enhance the existing streetscape and ensure appropriate development scale and interface near heritage buildings and residential areas.

## High-quality residential development

### Objectives

- O18. To position the Five Dock Town Centre as an attractive place to live.

#### Controls

- |      |  |
|------|--|
| C17. | Recommendations within the SEPP 65 (State Environmental Planning Policy No 65 - Design Quality of Residential Apartment Development) and the accompanying Apartment Design Guide are adopted by this DCP for apartment developments. |
|------|--|

## Landscaping and setbacks

### Objectives

- O19. To ensure that the amenity of residents, workers and visitors to the centre is enhanced by high quality landscaping.
- O20. To create appropriate landscaping for private and common open space areas.
- O21. To soften and screen the interface between buildings in the centre and adjoining residential areas.
- O22. To increase building separation along East Street between Henry Street and Lyons Road West.
- O23. To encourage the landscape character of West Street to continue past new development and up to Garfield Street.

#### Controls

- |      |  |
|------|--|
| C18. | Landscape setbacks are to be in accordance with 'Fig G3.46 Primary Setbacks'   |
| C19. | A landscape plan prepared by a qualified Landscape Architect is to be submitted with the development application that shows levels adjacent to the public domain; planting schedules; and type and detail of paving, fencing and other details of external areas.  |
| C20. | The area within the minimum landscape setback is to be a deep soil zone, i.e. where there are no structures below.   |
| C21. | For residential apartment development common open space is to be provided that occupies a minimum of 25% of the site area and has a minimum dimension of 3.0m. The common open space may be located on an elevated garden (i.e. above car parking) or on roof tops provided the area provides for the recreational and amenity needs of residents. |
| C22. | Landscaping is to give preference to species with low water needs, including native plant species and select and position trees and shrubs to control sun and winds and provide privacy.   |

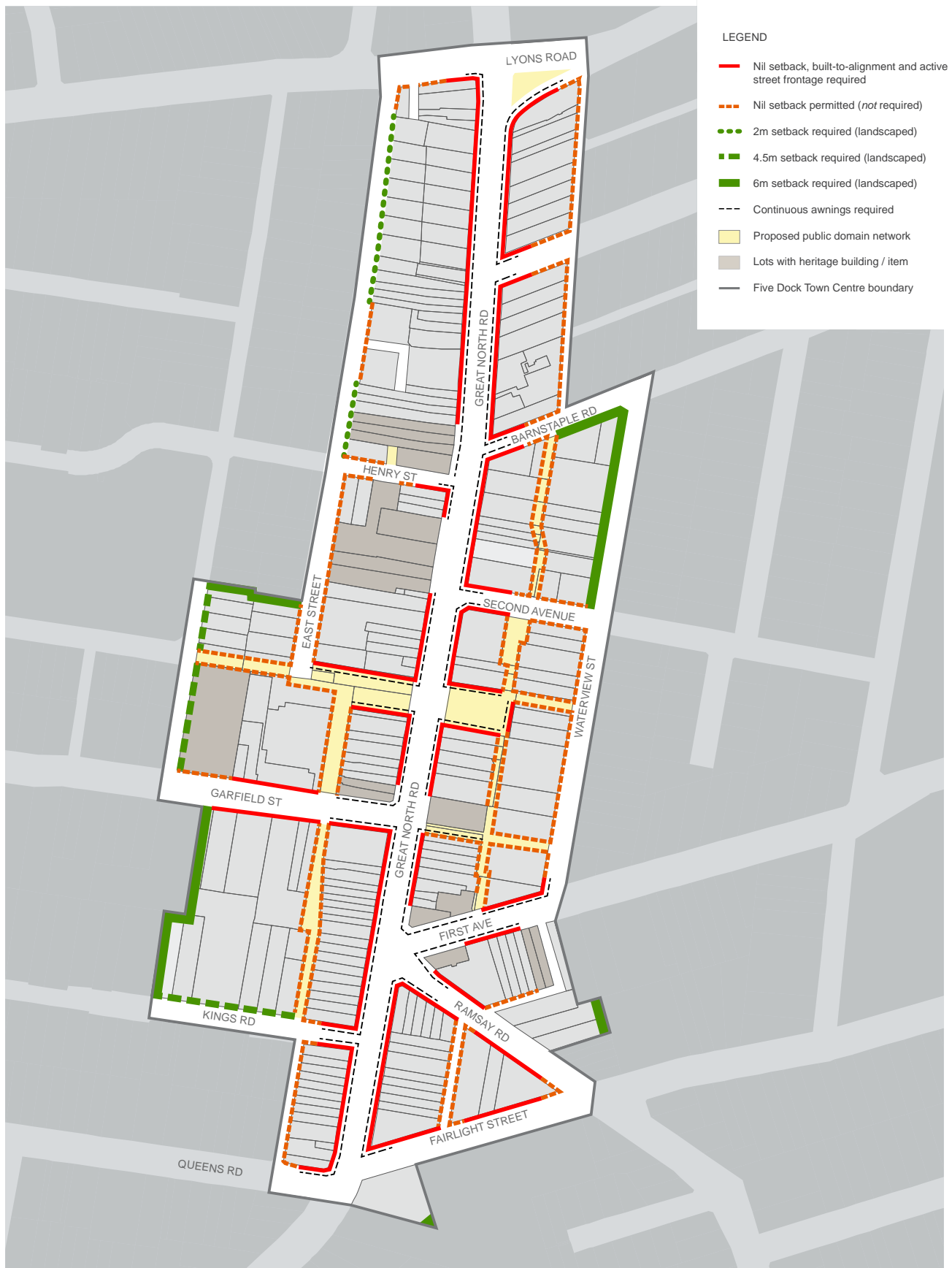

Fig G3.46 Primary Setbacks



## Building setbacks

For the purpose of this section of the DCP, the primary building setback is the setback between the public domain/street boundary and the building alignment, and the secondary building setback is the additional setback above the street wall height.

### Objectives

- O24. To allow redevelopment and gradual transition to higher densities while at the same time respecting heritage buildings and the 'village character' of the centre.
- O25. To locate balconies and terraces along streets and laneways where they can provide passive surveillance (and increased safety) of streets and public open spaces.
- O26. To reduce potential negative impacts of development such as overshadowing of streets and public open spaces.
- O27. To minimise negative impacts of development on existing development in the town centre and surrounding the town centre.

### Controls

|      |  |
|------|--|
| C23. | Building setbacks are to be in accordance with 'Fig G3.46 Primary Setbacks', 'Fig G3.47 Secondary (Upper Level) Setbacks', 'Fig G3.49 Maximum Street Wall Heights', 'Fig G3.51 Example street frontage section showing maximum potential building height' and 'Fig G3.52 Maximum Building Height Zones' and any additional controls set out below. |
| C24. | Any additional floors above four storeys have a minimum setback of 6.0m unless otherwise shown in 'Fig G3.47 Secondary (Upper Level) Setbacks'.  |
| C25. | Where possible along 6.0m wide laneways, increase setbacks above two (2) storeys and/or increase ground level setbacks to improve pedestrian amenity.  |

## Active frontages

Active frontages and uses contribute to visual and physical activity in the centre and include community and civic facilities, recreation and leisure facilities and shops, restaurants and cafes.

### Objectives

- O28. To promote activity and interest along key streets in the centre, in particular along Great North Road
- O29. To enhance the commercial viability and function of the centre and compliment current retail, commercial, entertainment and community uses.
- O30. To enhance safety and security in the centre.

### Controls

|      |  |
|------|--|
| C26. | Provide ground level active uses where indicated on 'Fig G3.46 Primary Setbacks'.  |
| C27. | Residential entries and foyers are permitted along active street frontages but are not to dominate or compromise the commercial viability of the street.           |
| C28. | Where required, active uses must be at least 10.0m deep.   |
| C29. | A continuous awning is to be provided where indicated on 'Fig G3.46 Primary Setbacks', and meet the requirements of Section 'G2.2 Building design and appearance'. |
| C30. | Vehicle access points are not permitted along active street frontages. Where rear or side access is not possible, development without parking will be considered.  |

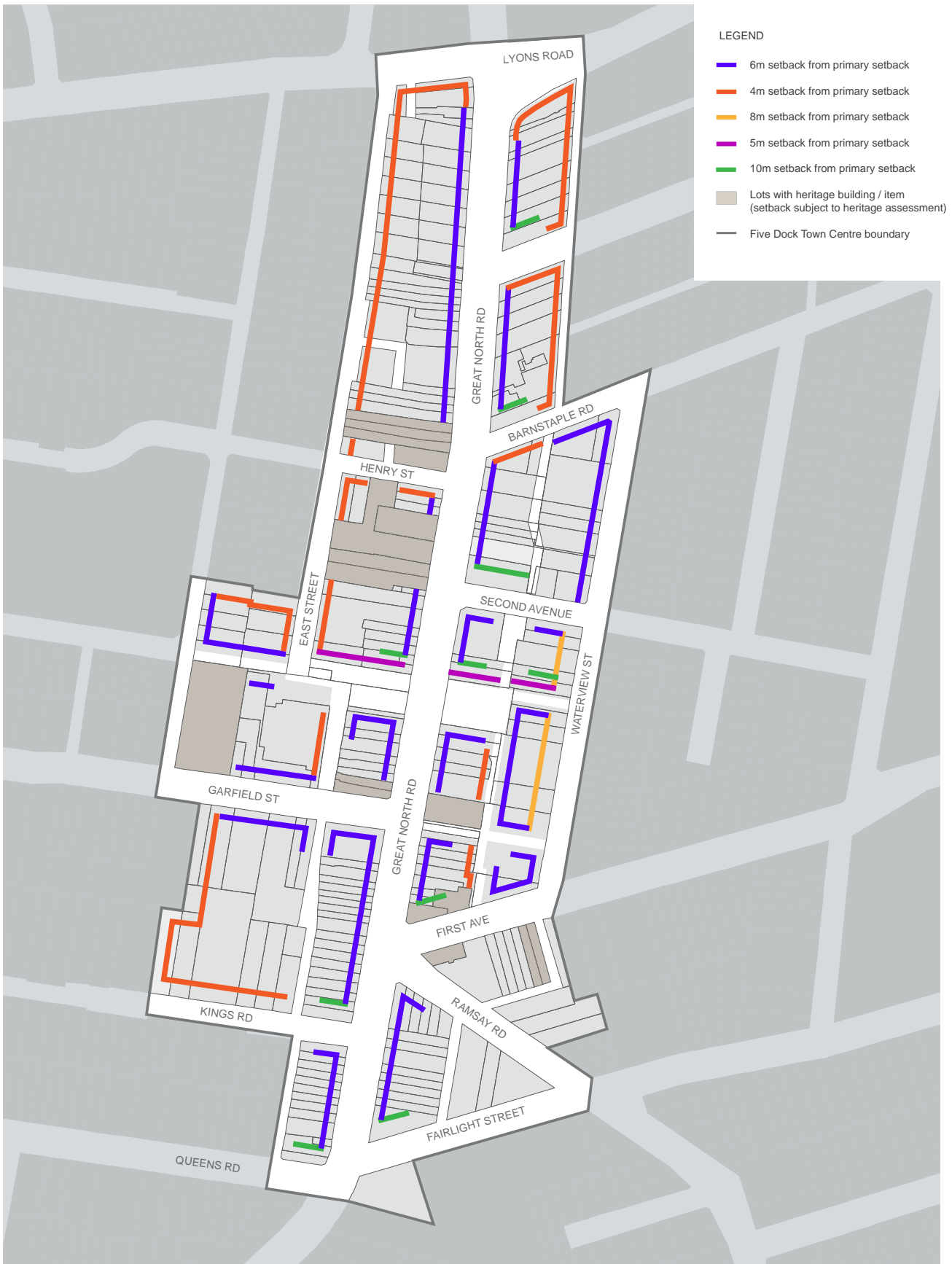

Fig G3.47 Secondary (Upper Level) Setbacks



## Ground floor residential

### Objectives

- O31. To ensure residential dwellings on the ground level have a high level of amenity and create a positive interface with the street.

#### Controls

|      |   |
|------|---|
| C31. | Residential uses will only be permitted on the ground floor within the R3 Medium Density Residential zone.  |
| C32. | The floor to ceiling height of ground level residential is to meet the requirements of the "Adaptable" category of 'Table G-A Minimum Floor Heights'.                         |
| C33. | Ground floor private open space on the street frontage is to be designed as a private terrace a minimum of 0.4m and a maximum of 1.0m above the adjacent public domain level. |
| C34. | Dwellings on the ground floor facing the street are to have individual entries from the street.   |

## Site amalgamation and isolated sites

Site amalgamations will result in a more efficient built form. This is particularly true of corner sites which could be integrated with adjoining land to both maximise development potential and also provide enhanced amenity for building occupants and for users of public, communal and private open space.

### Objectives

- O32. To encourage site consolidation of allotments for development in order to promote the efficient use of land.
- O33. To avoid development that may create isolated sites.
- O34. To support more efficient car parking and servicing and reduced number of driveways.
- O35. To support the provision of new and/or improved public spaces as identified in 'Fig G3.45 Public Domain'.
- O36. To avoid the creation of isolated sites that may be incapable of being developed in a manner that responds to the site's context and characteristics and that maintains a satisfactory level of amenity.

#### Controls

|      |  |
|------|--|
| C35. | Provide new or improved connections as identified in 'Fig G3.45 Public Domain'.  |
| C36. | Where development may create an isolated site, the applicant is required to demonstrate negotiations with property owners to include the site commenced early, well prior to the lodgement of the development application. Written evidence of negotiations is to be provided, including reasonable offers based on independent valuation and that take into account expenses likely to be incurred. |
| C37. | Where development may create an isolated site, the applicant must demonstrate with a schematic design that the isolated site can be redeveloped under the current planning controls. This must demonstrate the likely impacts between the development and the isolated site such as solar access, separation distances and privacy.  |
| C38. | Site amalgamation should seek to minimise the number of driveway crossings provided to the street.   |

## Fine grain frontages

### Objectives

- O37. To ensure development of existing small and/or narrow lots prevalent in the centre can still occur.
- O38. To ensure a diversity of retail shop size.
- O39. To encourage narrow frontage, fine grain retail in the centre.

#### Controls

|      |   |
|------|---|
| C39. | On narrow sites less than 12.0m wide alternative methods to address car parking, including car share, off site provision and/or exemptions are encouraged.                        |
| C40. | Developments are to create retail frontages of less than 8.0m in width or be designed so that larger frontages can be divided into smaller units in the future.                   |
| C41. | Reinforce the fine grain of the centre by creating smaller shop fronts or by providing articulation so that the flexibility exists to create narrower shops (5-7m) in the future. |

Fig G3.48 Built form sections

**Section A**

Interface Waterview Street

Along Waterview Street the street wall height is four (4) storeys. Active street frontages, providing both residential and non-residential uses at street level are encouraged.

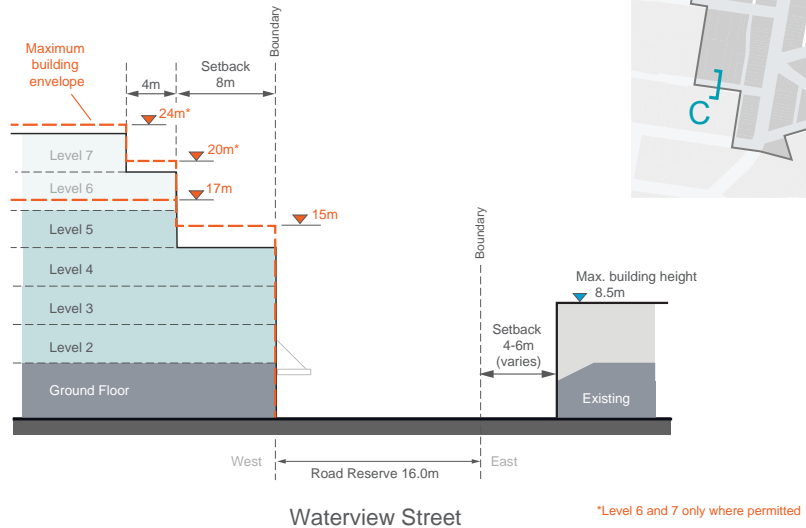

**Section B**

Interface East Street

East Street has a landscape setback of 0-2.0m. The street wall is three (3) storeys with an additional setback of 4.0m to the fourth (4) storey. Residential uses at street level are encouraged along this street.



**Section C**

Interface Kings Road

Kings Road has a landscaped setback of 4.5m. The street wall height is three (3) storeys with a maximum building height of 15.0m.

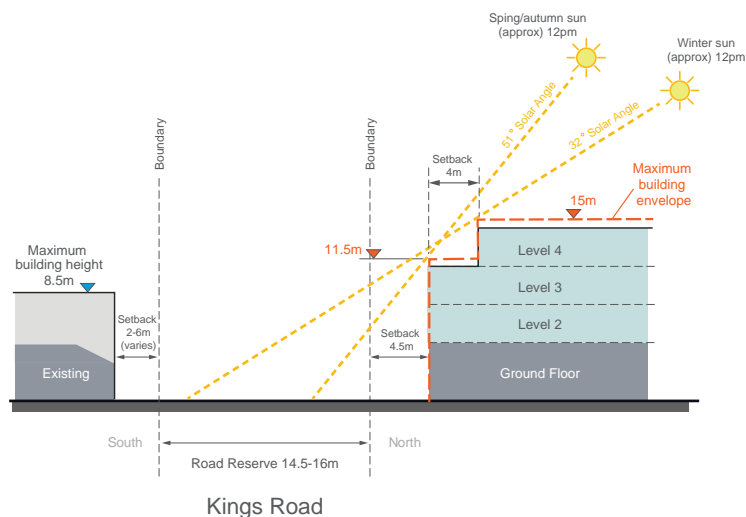

**Section D**

**Interface New Town Square**

In order to allow for direct sunlight in the new town square, buildings on the north side of the square are required to have a three (3) storey street wall and a 5m setback for each level above.

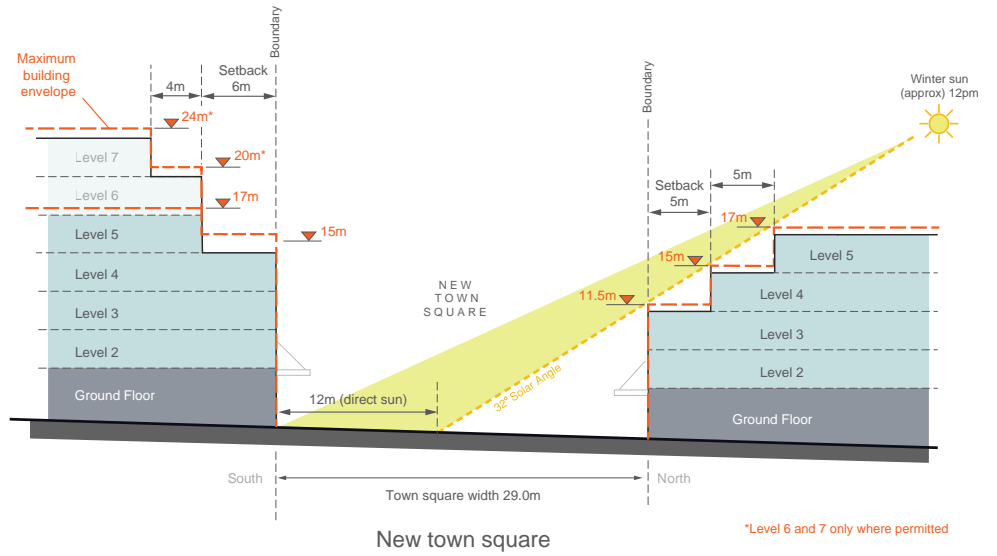

**Section E**

**Interface Barnstaple Road (West)**

Along Barnstaple Road to the west of the proposed laneway, the street wall height on both sides of the street is four (4) storeys. The upper level setbacks of built form to the north facilitates solar access to Barnstaple Road.

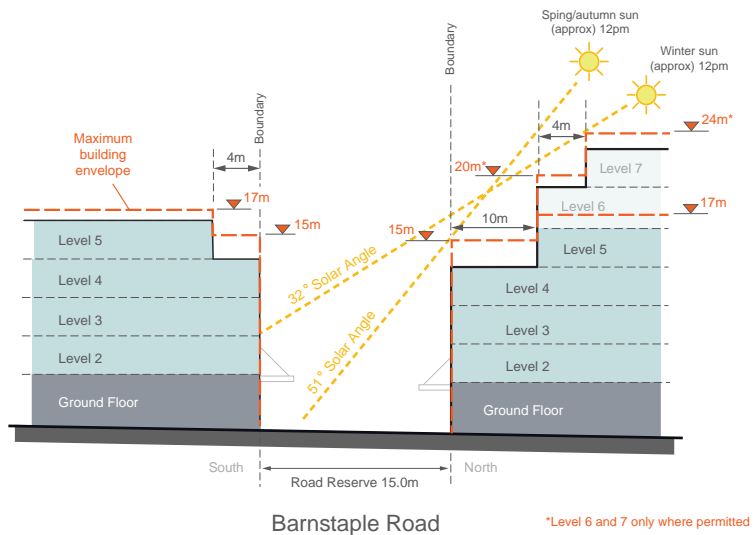

**Section F**

**Interface Barnstaple Road (East)**

Along Barnstaple Road to the east of the proposed laneway, the maximum street wall height on the southern side of the street is three (3) storeys.

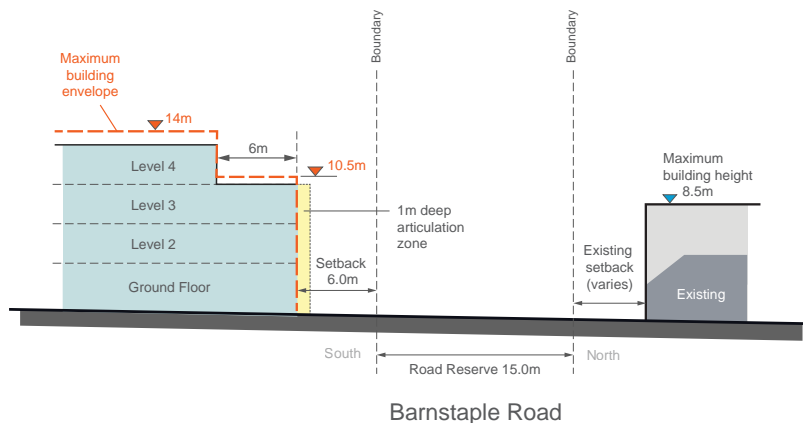



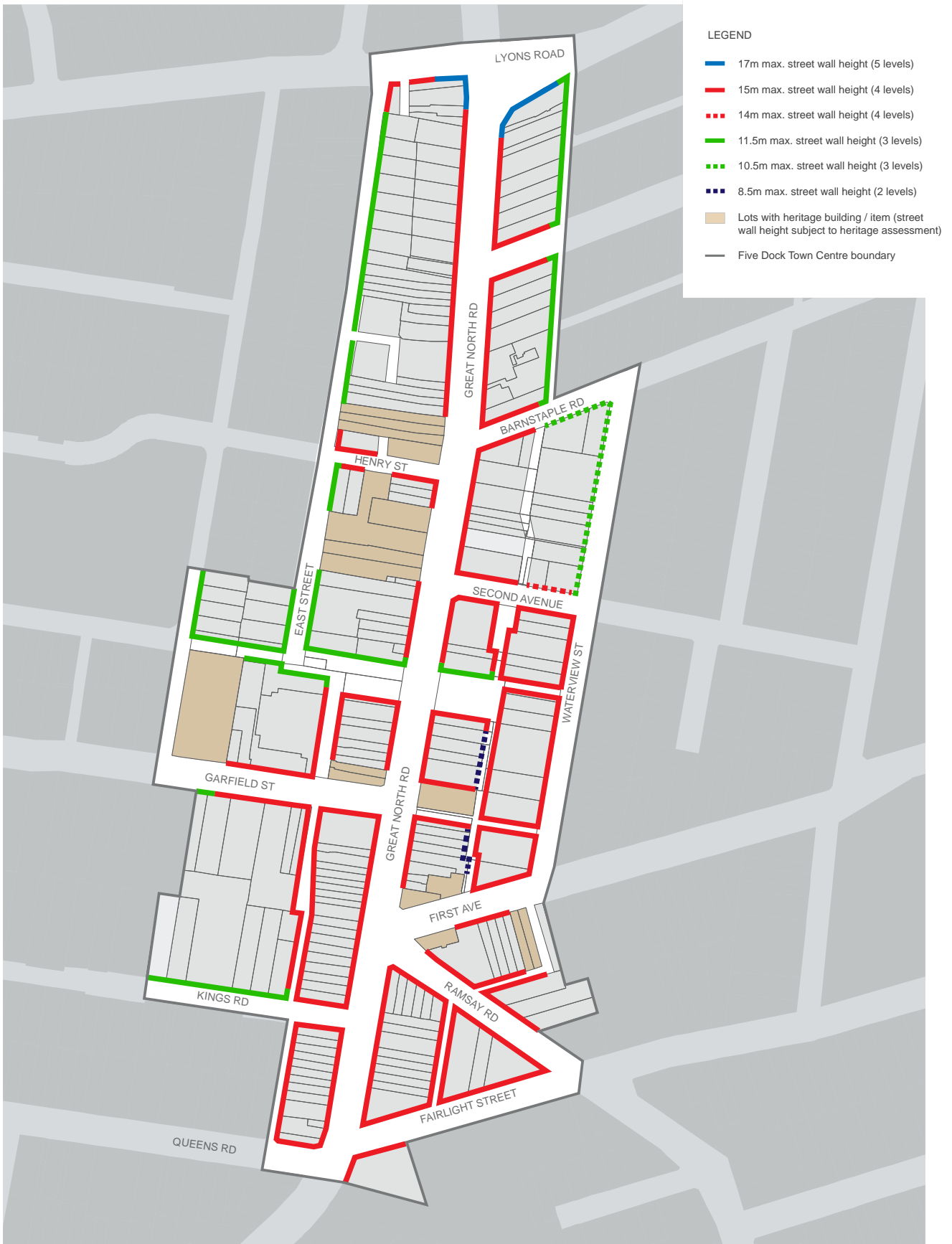

Fig G3.49 Maximum Street Wall Heights



## Build to alignment

### Objectives

- O40. To encourage a consistent street alignment and street wall height along key streets in the centre.
- O41. To ensure corner buildings, located where two streets meet, provide a continuous street edge and front both streets.
- O42. To ensure new buildings provide a well-defined, active edge to areas of public open space.

### Controls

|      |  |
|------|--|
| C42. | Building setbacks are to be in accordance with 'Fig G3.46 Primary Setbacks', 'Fig G3.47 Secondary (Upper Level) Setbacks', 'Fig G3.49 Maximum Street Wall Heights' and 'Fig G3.51 Example street frontage section showing maximum potential building height'; and any additional controls set out below. |
| C43. | The nil setback applies only to the first four (4) storeys of development, unless otherwise indicated in 'Fig G3.47 Secondary (Upper Level) Setbacks'.   |

## Building heights

### Objective

- O43. To ensure adequate sunlight is available for all buildings, streets and public open spaces.
- O44. To ensure the ground floor levels along key streets in the centre are appropriate for retail uses and that ground levels in the remaining streets are adaptable over time to a wide range of uses.
- O45. To encourage redevelopment while at the same time respecting heritage buildings and the "village character" of the centre.

### Controls

|      |   |
|------|---|
| C44. | Building heights are to be in accordance with 'Fig G3.46 Primary Setbacks', 'Fig G3.47 Secondary (Upper Level) Setbacks', 'Fig G3.48 Built form sections', 'Fig G3.49 Maximum Street Wall Heights', 'Fig G3.51 Example street frontage section showing maximum potential building height' and 'Fig G3.52 Maximum Building Height Zones'; and any additional controls set out below. |
|------|---|

|      |   |
|------|---|
| C45. | Development is to be consistent with the minimum floor to ceiling heights for the specified uses within the centre shown in 'Table G-A Minimum Floor Heights'.  |
| C46. | For development sites to the north of Fred Kelly Place and the new town square the maximum building height is to be in accordance with 'Fig G3.47 Secondary (Upper Level) Setbacks' and 'Fig G3.52 Maximum Building Height Zones'; and no incursions (including plant, balcony rails etc.) are to be permitted. |
| C47. | The finished floor level of the ground floor above the footpath level is to be no greater than 1.0 metre for residential uses and 0.4 metre for retail and commercial uses.   |
| C48. | Where active uses are specified on the ground floor as identified in 'Fig G3.46 Primary Setbacks', the minimum floor to ceiling height is to comply with the category of "Retail - restaurant/cafe" in 'Table G-A Minimum Floor Heights'.   |
| C49. | Where active uses are not specified on the ground floor, the minimum floor to ceiling height is to comply with the category of "Retail - general" in 'Table G-A Minimum Floor Heights'.   |
| C50. | Building heights are to conform with 'Table G-B Building Heights', which shows the relationship between the height of building in storeys and the height of the building in metres.   |
| C51. | New buildings are to have a scale that is visually compatible with adjacent buildings and heritage items. This may require the height of new development to be lower than the maximum height permitted.   |
| C52. | The upper-most level is to be designed to reduce the visual bulk and scale of the building. Options to achieve this include increased setbacks and/or the use of dark colours and roof elements that create deep shadows.   |

**Table G-A Minimum Floor Heights**

| Use                       | Floor to ceiling height in metres (min) | Approx. floor to floor height in metres (min) |
|---------------------------|---|---|
| Retail - general          | 3.3m                                    | 3.7m  |
| Retail - restaurant /cafe | 4.0m                                    | 4.4m  |
| Commercial                | 3.0m                                    | 3.6m  |
| Adaptable                 | 3.3m                                    | 3.7m  |
| Residential               | 2.7m                                    | 3.1m  |
| Community                 | 3.0m                                    | 3.6m  |

**Table G-B Building Heights**

| Building height (in metres) | Building height* |
|-----------------------------|------------------|
| 24.0m                       | 7 storeys        |
| 20.0m                       | 6 storeys        |
| 17.0m                       | 5 storeys        |
| 15.0m                       | 4 storeys        |
| 11.5m                       | 3 storeys        |
| 8.5m                        | 2 storeys        |

\* The number of storeys possible within any maximum building height is dependent on the use (refer to Fig G3.50)

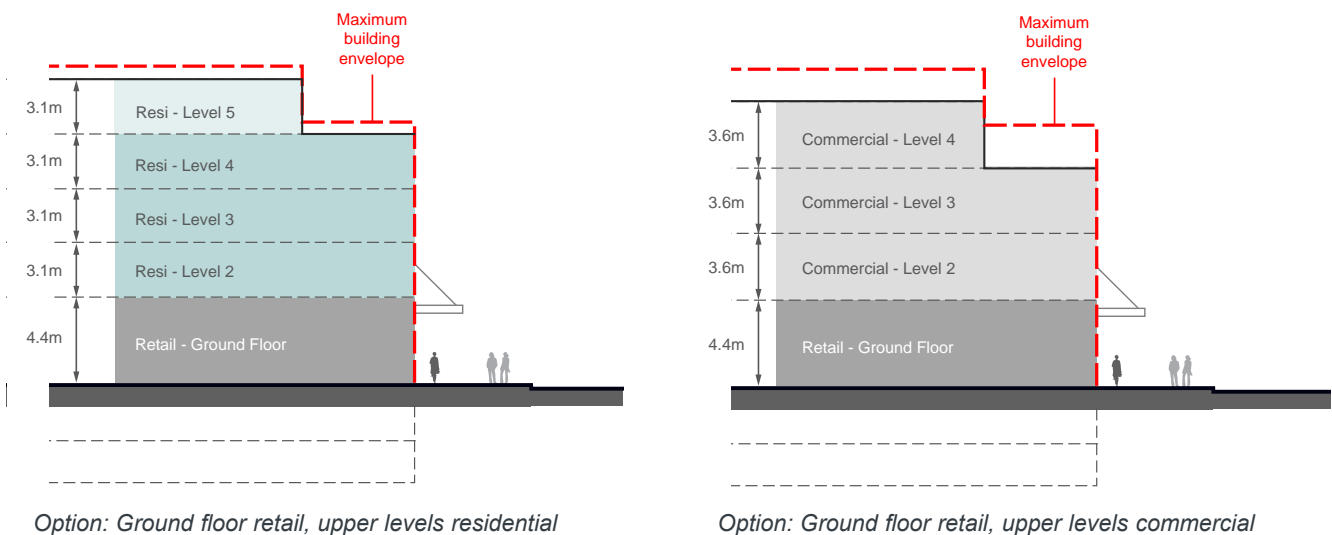

Fig G3.50 Alternate uses within the building envelope

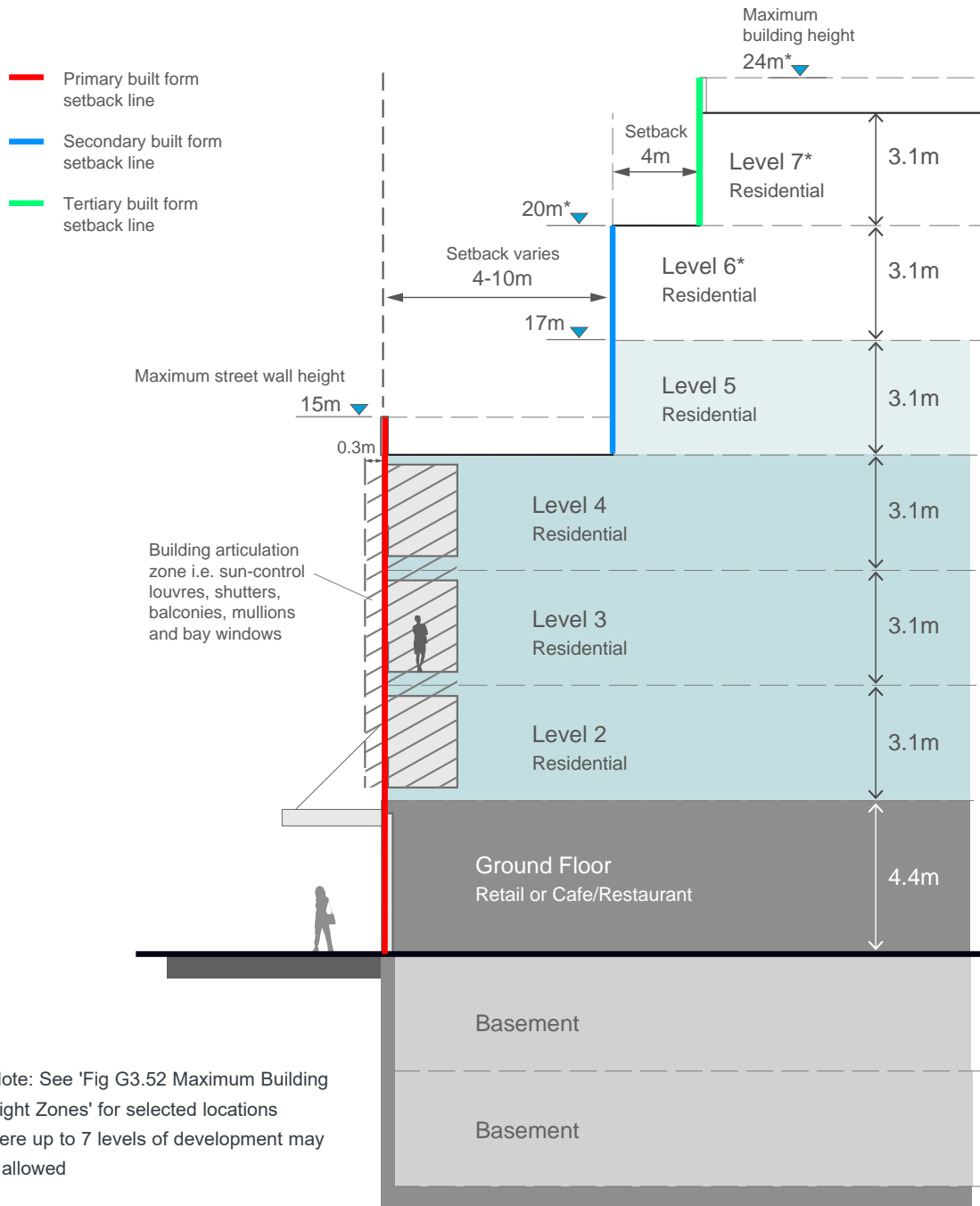
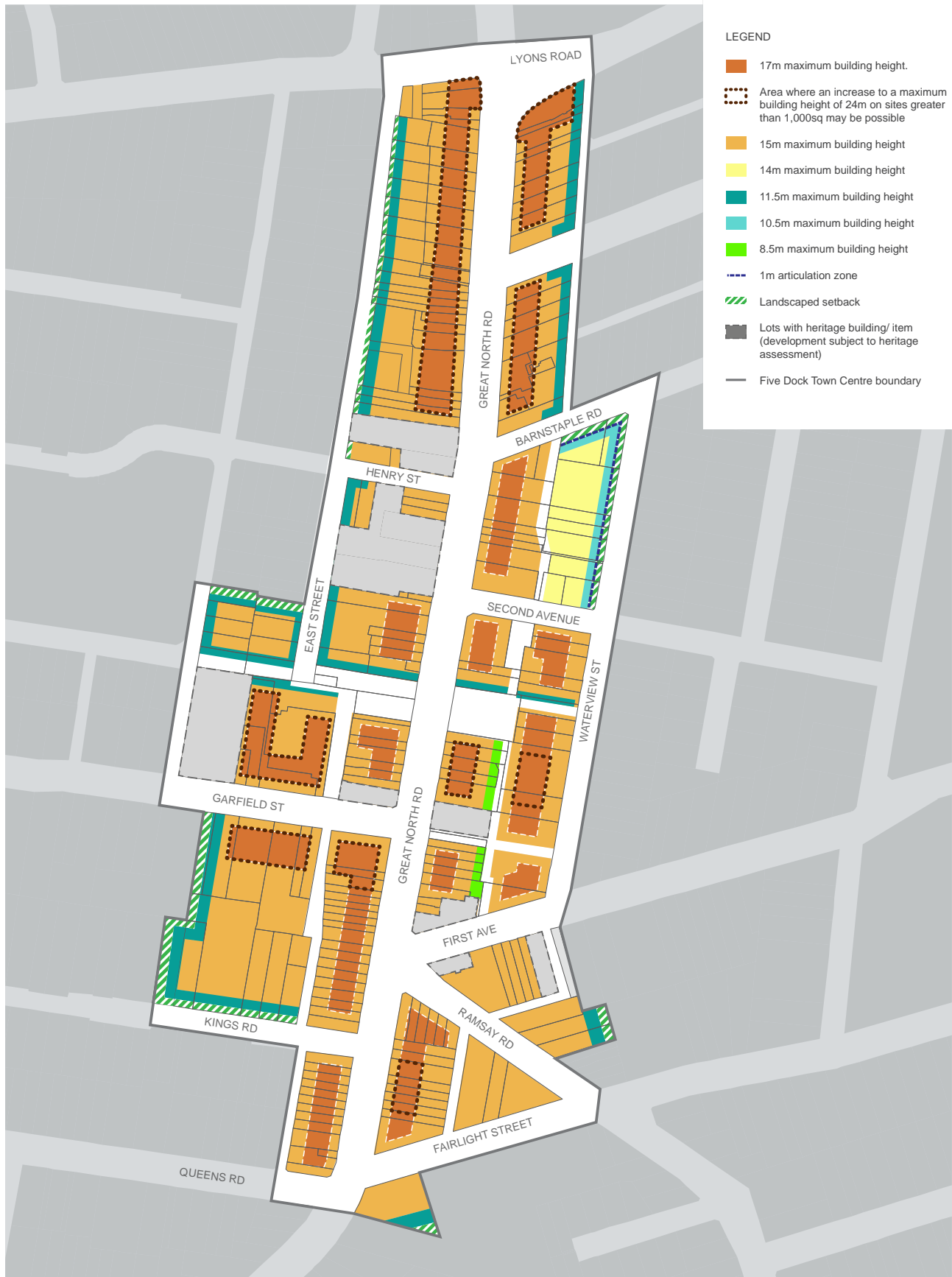

Fig G3.51 Example street frontage section showing maximum potential building height



LEGEND

- 17m maximum building height.
- Area where an increase to a maximum building height of 24m on sites greater than 1,000sq may be possible
- 15m maximum building height
- 14m maximum building height
- 11.5m maximum building height
- 10.5m maximum building height
- 8.5m maximum building height
- 1m articulation zone
- Landscaped setback
- Lots with heritage building/ item (development subject to heritage assessment)
- Five Dock Town Centre boundary

Fig G3.52 Maximum Building Height Zones

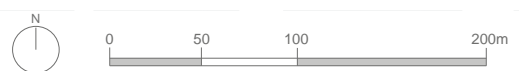
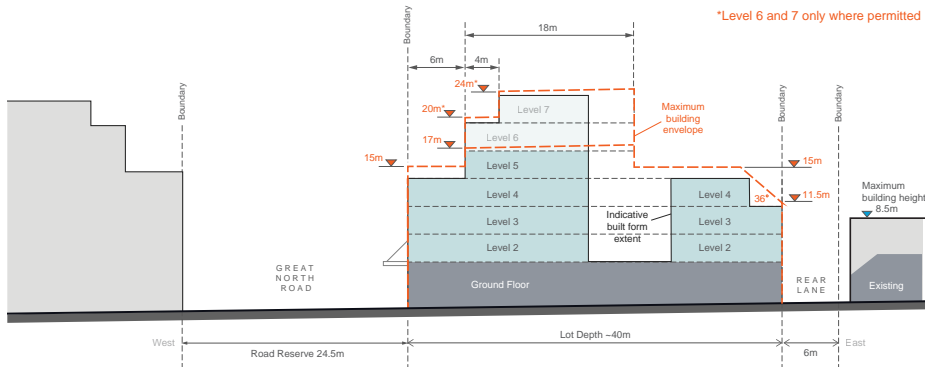
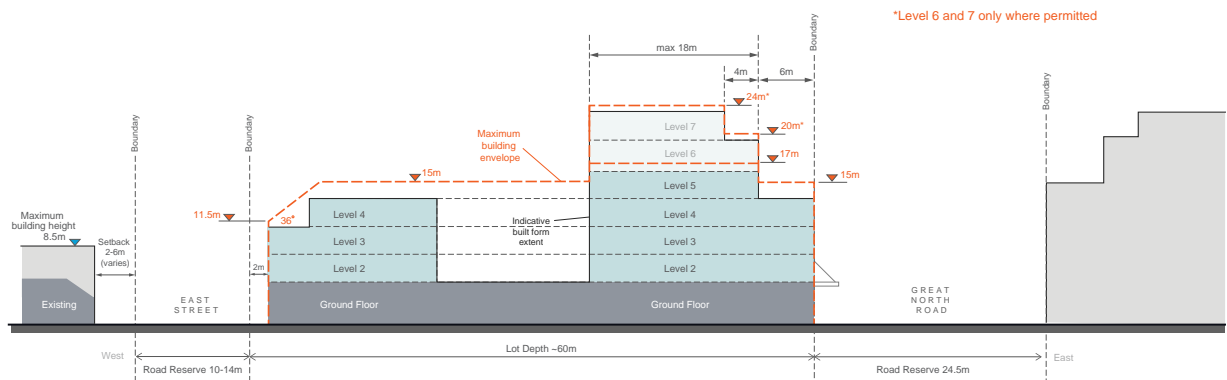

Fig G3.53 Building envelope sections



Section G



Section H

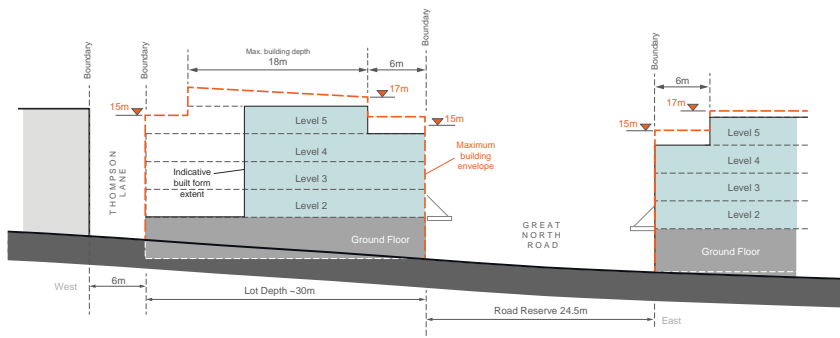

Section J

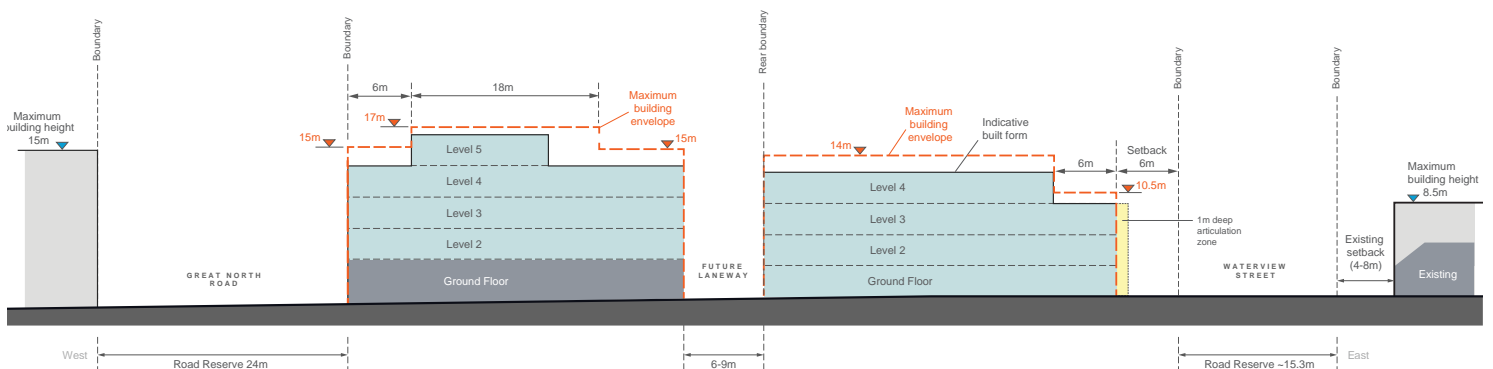

Section K

## Facades

### Objectives

- O46. Buildings are to provide facade articulation and variation to reduce visual bulk and create shadows and texture along the facade. This can include variations in window and/or balcony size and treatment, a design with a well-defined base, middle and top, the use of horizontal and/or vertical elements and variations in setback.

### Controls

|      |   |
|------|---|
| C53. | Balconies are to support a balance of solid and void treatment in the composition of the facade. A facade which is dominated by a repetitive balcony design is to be avoided.   |
| C54. | External walls are to include variations in colour and the types of materials used in order to articulate different parts of a building facade and reduce the overall bulk and scale.   |
| C55. | External walls are to be constructed of high quality and durable materials and finishes with 'self-cleaning' attributes such as face brickwork, rendered brickwork, stone, concrete and glass. Materials and finishes with high maintenance costs, and those susceptible to degradation or corrosion are to be avoided.                           |
| C56. | A 1m deep facade 'articulation zone' for architectural expression and elements (e.g. balconies) is permitted within the primary setback zone along Waterview Street and Barnstaple Road as identified in 'Fig G3.52 Maximum Building Height Zones'. The maximum length of straight wall, without articulation such as a balcony or return, is 8m. |



*Example of balconies with a balance of solid and void in the facade composition and treatment*

**Heritage**

**Objective**

O47. To protect buildings and spaces of heritage significance.

O48. To ensure that new development on the same site as or adjacent to a heritage item responds sensitively to its heritage significance.

**Controls**

|             |  |
|-------------|--|
| <p>C57.</p> | <p>New buildings on the same site as or adjoining a heritage item will need to consider the impact on heritage when determining:</p> <ul style="list-style-type: none"> <li>• the appropriate alignment and street frontage heights;</li> <li>• setbacks above street frontage heights;</li> <li>• appropriate materials and finishes selection;</li> <li>• the design and articulation of the facade; and</li> <li>• appropriate side and rear setbacks.</li> </ul> |
| <p>C58.</p> | <p>Prior to the demolition of the former heritage item at 39 Waterview Street, Five Dock (Lot 11 DP 869673), an archival record is to be prepared and submitted to Council.</p> <p>Once demolition has been completed, a Baseline Archaeological Assessment on the entire site is to be submitted.</p>   |



*The composition of the facade of the new building on the right considers the adjoining a heritage item on the left.*



### G3.3 Majors Bay Road Shopping Centre, Concord

Majors Bay Road Shopping Centre is a linear shopping centre with a strong boulevard quality. The street is well orientated for vistas and was laid out with the subdivisions of the surrounding estates for residential purposes between 1900-1915. The buildings within the centre, whilst not being particularly historic or architecturally impressive in themselves, impart a unified streetscape by virtue of their two storey scale and architectural styles. These elements convey a sense of history and continuity, form part of Canada Bay's cultural heritage, and provide a sense of identity to the shopping centre. The scale of the buildings also relates well to the surrounding low rise character of Concord.

The height of buildings is an important visual element in the streetscape and represents one of the more important facets of development control in the shopping centre. Most buildings in the Majors Bay Road shopping centre are two (2) storeys high and constructed with a flat, pitched or parapet-type roof. Roof forms on new buildings should be sympathetic to adjoining buildings and materials should be selected so as to blend with the surrounding environment. The design of the developments should attempt to ensure that where adjoining buildings, particularly residential dwellings, are located in close proximity to new commercial buildings, the design of such projects should attempt to minimise any potential loss of sunlight or daylight to residences.

Refer to Fig G3.54.

| Controls |   |
|----------|---|
| Height   |   |
| C1.      | All new work (including extensions to buildings) should not exceed a maximum height of 11.0 metres.   |
| C2.      | Where buildings display a uniform height at the front street alignment, new development should maintain a complementary height relationship with adjoining development. In this regard, any upper floor additions should be confined to the rear, either out of sight or setback far enough from the front building alignment so as to reduce its visibility and prominence from the shopping street. |

| C3.                        | Buildings are to step down at the rear, to a maximum external wall height of 7.5 metres, to be compatible with the scale and character of adjacent residential areas and in keeping with the built form pattern of retail streets.<br><br>Refer to Fig G3.55. |
|----------------------------|---|
| Siting                     |   |
| C4.                        | Where new buildings are erected within established frontages, such buildings should, at least along the main street frontage, be similarly orientated to existing adjoining buildings.  |
| Front setbacks             |   |
| C5.                        | New development should be built to the predominant setback, generally the front alignment.  |
| Roof forms                 |   |
| C6.                        | The style and pitch of new roofs should relate sympathetically to neighbouring buildings where possible.  |
| C7.                        | Materials used in the construction of roofs should be selected so as to blend in and harmonise with both the subject building, adjoining properties, and the streetscape generally.   |
| C8.                        | Structures such as ventilation shafts, lift towers etc. should not project above the roof line or disturb the symmetry of the roofscape of buildings.   |
| Vehicular access/crossings |   |
| C9.                        | New vehicular access ways across public footpaths within the shopping centre will not generally be permitted.   |
| C10.                       | Where rear lane access and/or parking facilities are provided to properties, Council will request owners (either by co-operation or via conditions attached to development applications) to close existing front vehicular access ways.                       |

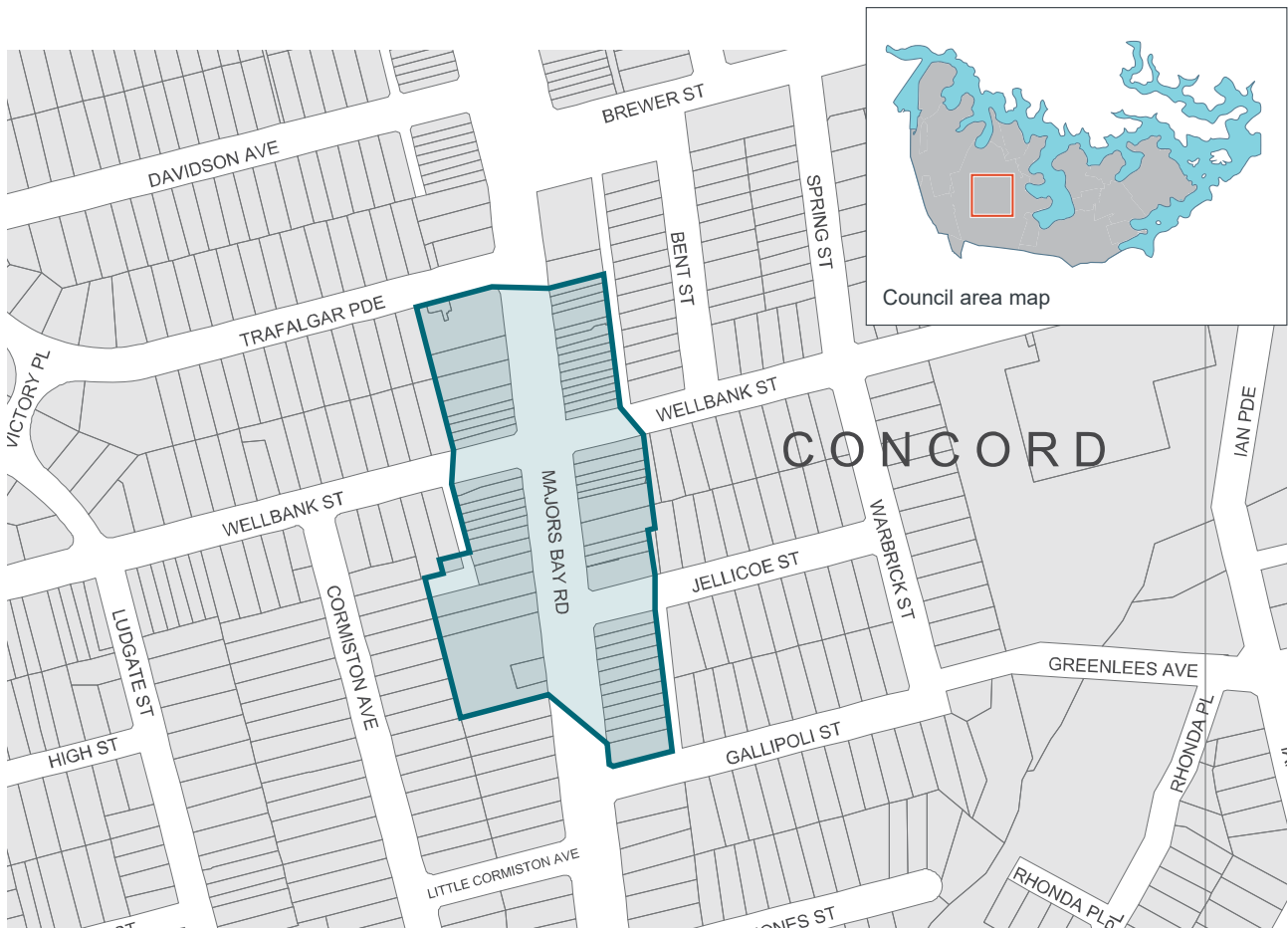

Fig G3.54 Majors Bay Shopping Centre - Location Plan

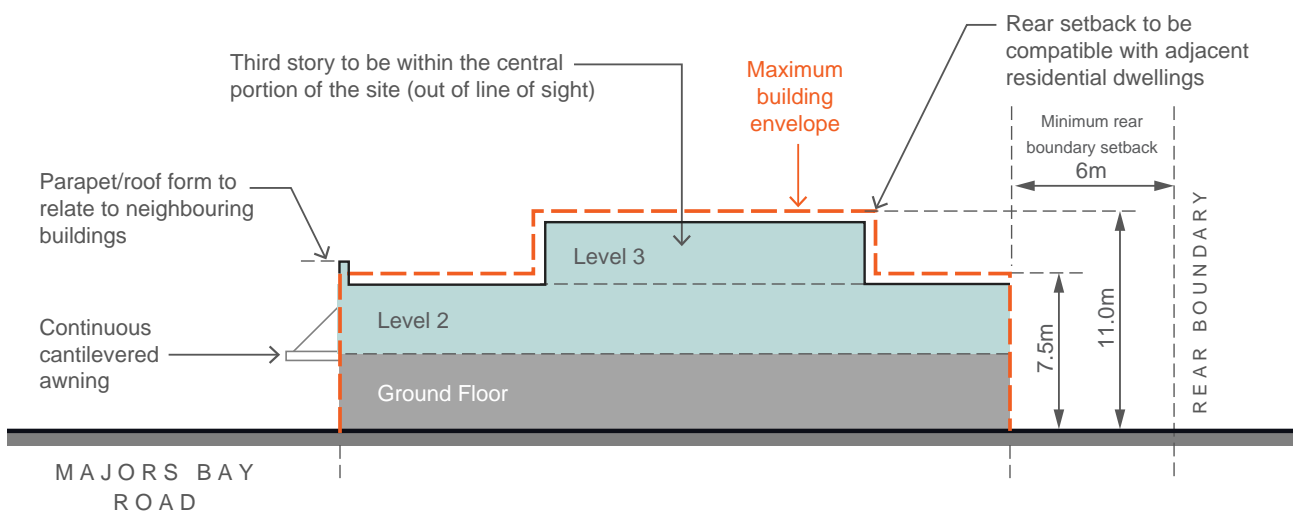

Fig G3.55 Majors Bay Shopping Centre - Maximum Building Envelope Section

### G3.4 Victoria Avenue Shopping Centre, Concord West

Most buildings in the shopping centre are one (1) to two (2) storeys in height and are constructed with flat, pitched or parapet type roofs.

There is a shortage of car parking in the centre which was designed and constructed before the advent of mass car ownership. The rear building line is intended to reserve parts of lots for future parking and loading areas accessed from rear service roads and to prevent such areas being “built out”. This building line applies to both new and existing buildings.

Refer to Fig G3.56.

| Controls          |  |
|-------------------|--|
| Floor space ratio |  |
| C1.               | The residential component of buildings is not to exceed 50% of the total gross floor area.                                     |
| Front setbacks    |  |
| C2.               | New development or extensions to existing buildings should be built to the predominant setback, generally the front alignment. |
| Rear setbacks     |  |
| C3.               | New development or extensions to existing buildings should be built a minimum of six (6) metres from the rear boundary.        |

| Building height           |   |
|---------------------------|---|
| C4.                       | Where buildings display a uniform height at the front street alignment, new development should maintain a complementary height relationship with adjoining development. In this regard, any upper floor additions should be confined to the rear, either out of sight or setback far enough from the front building alignment so as to reduce its visibility and prominence from the shopping street. |
| C5.                       | Buildings are to step down at the rear, to a maximum external wall height of 7.5 metres, to be compatible with the scale and character of adjacent residential areas and in keeping with the built form pattern of retail streets.<br><br>Refer to Fig G3.57.   |
| Building design           |   |
| C6.                       | The design of new buildings should respect the existing built form of the shopping centre. New buildings, particularly those which “infill” between existing properties, should respect the scale, roof forms and proportions of adjoining buildings. This means that new buildings should attempt to “fit in”.   |
| Vehicular access/crossing |   |
| C7.                       | New vehicular access ways across public footpaths within the shopping centre will not generally be permitted.   |
| C8.                       | Where rear lane access and/or parking facilities are provided to properties, Council will request owners (either by co-operation or via conditions attached to development applications) to close existing vehicular access ways.   |



Fig G3.56 Victoria Avenue Shopping Centre - Location Plan

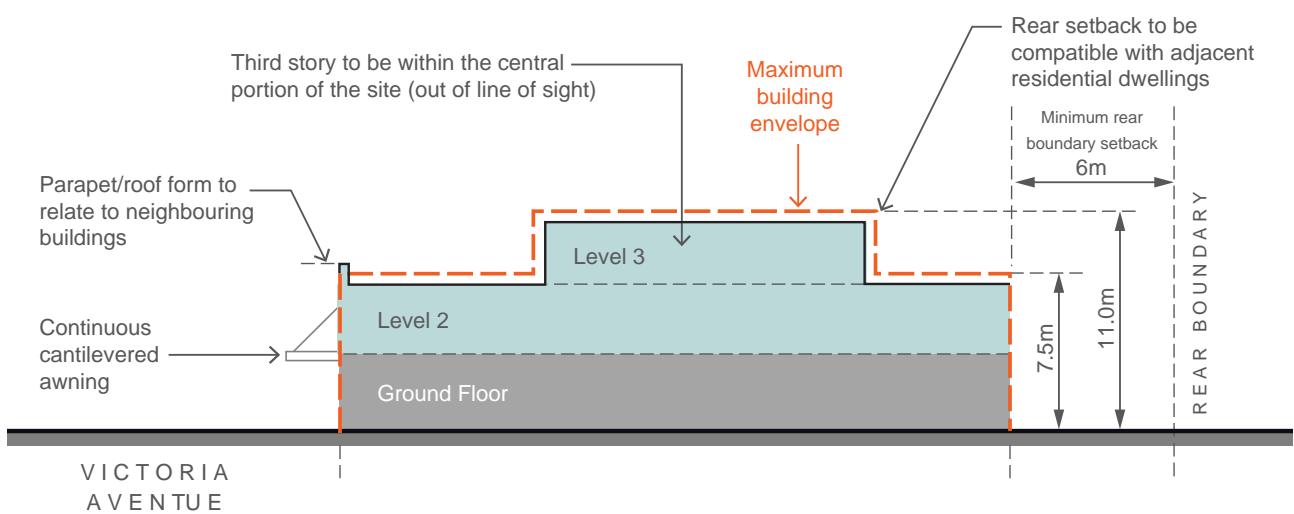

Fig G3.57 Victoria Avenue Shopping Centre - Maximum Building Envelope Section

### G3.5 355-359 Lyons Road, Five Dock

The land at 355 – 359 Lyons Road is part of a small cluster of shops that are surrounded by a predominantly residential area. The general planning controls outlined below apply in these areas to ensure the form and scale of development responds to the surrounding context and achieves an integrated urban design outcome for all properties between 355 and 359 Lyons Road.

#### Objectives

- O1. To achieve a coordinated urban design outcome.
- O2. To enhance the existing streetscape and ensure appropriate development scale and interface near residential areas.
- O3. To minimise solar access and privacy impacts upon surrounding properties.
- O4. To ensure future buildings provide a continuous street edge to Lyons Road.

| Controls |   |
|----------|---|
| C1.      | Buildings are to be constructed to the front boundary (street edge) on Lyons Road.  |
| C2.      | A continuous awning is to be provided on the Lyons Road frontage of the site and wrap around into Ingham Avenue.  |
| C3.      | Buildings are to adhere to the minimum separation requirements of the Apartment Design Guide.   |
| C4.      | The maximum building height is 3 storeys.   |
| C5.      | A two (2) storey street edge is to be provided to Lyons Road and Ingham Avenue and the third floor is to have an upper level setback of 3.0 metres from both of these streets and a solid 'parapet style' balustrade for the upper floor. |

|     |   |
|-----|---|
| C6. | The building envelope is the three dimensional volume that defines the outermost part of the site that buildings may occupy. Proposed buildings will also need to demonstrate that solar access is maintained to the north facing window and private open spaces of surrounding properties. |
| C7. | The third storey element of the building is to have a roof design and material selection that assists in minimising the overall bulk and scale of the building.   |



*Example of an increased setback to the upper floor and a solid parapet balustrade that helps the building to 'read' as a two storey building from the street.*



Fig G3.58 Consolidated development controls plan

LEGEND

- 1 level max. building height
- 2 level max. building height
- 3 level max. building height
- Nil setback to boundary
- 3m min. setback to boundary
- 6m min. setback to boundary
- Awning required
- Cadastre
- Site boundary

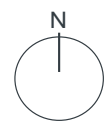

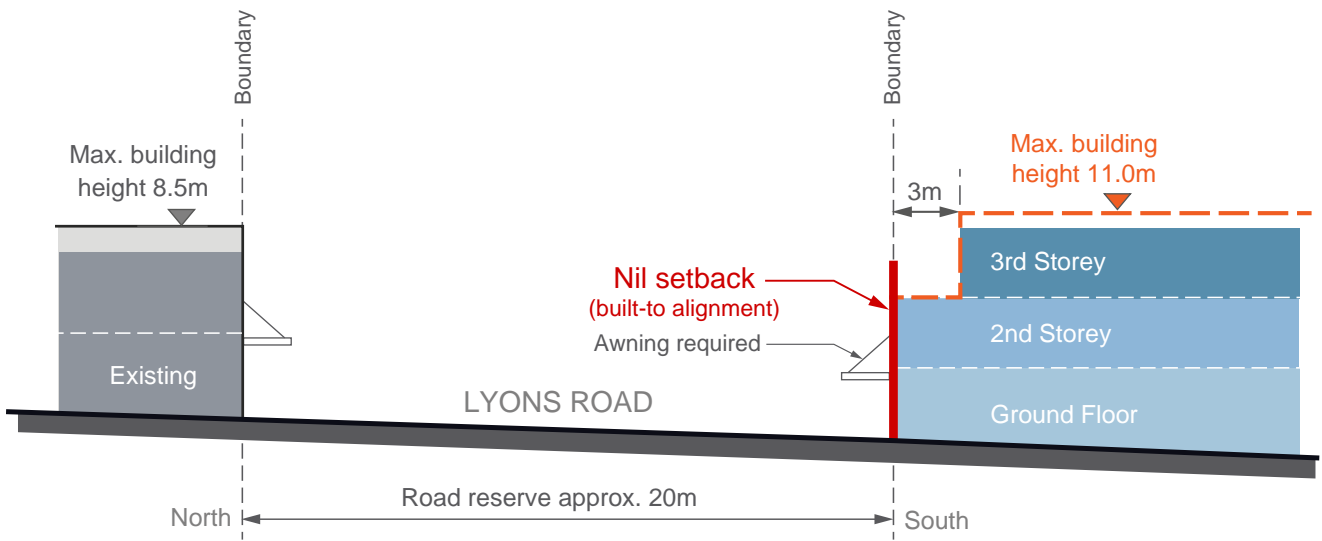
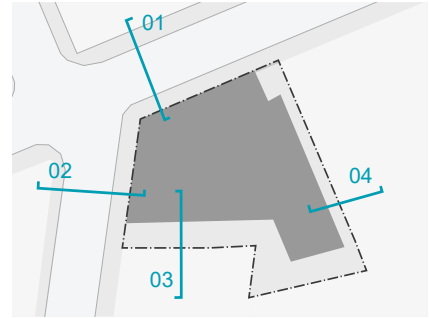

Fig G3.59 Interface section - Lyons Road

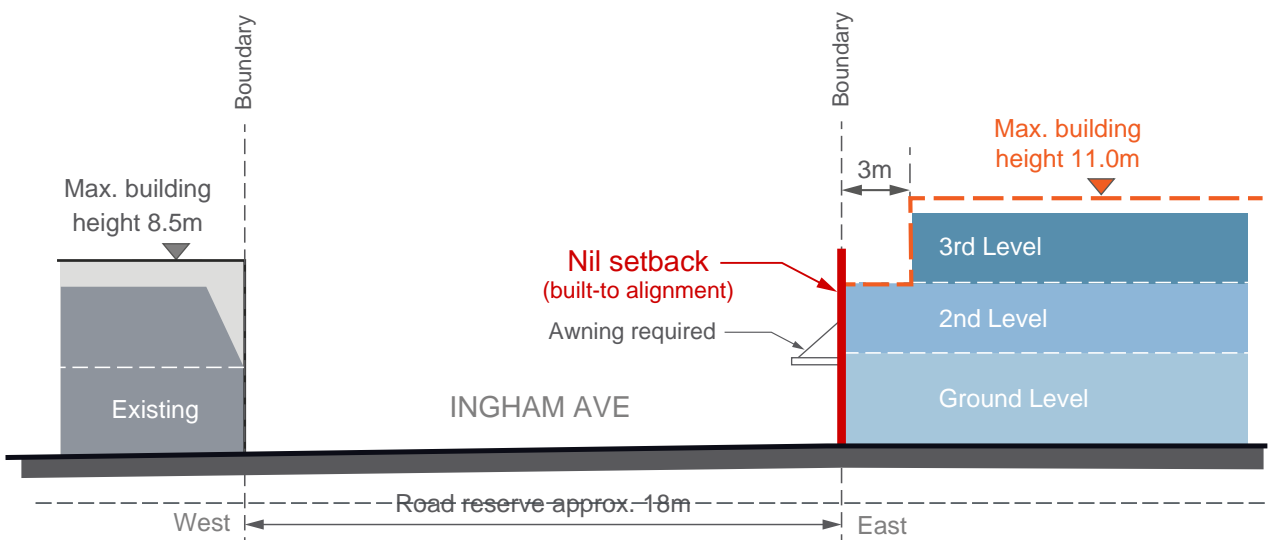

Fig G3.60 Interface section - Ingham Avenue

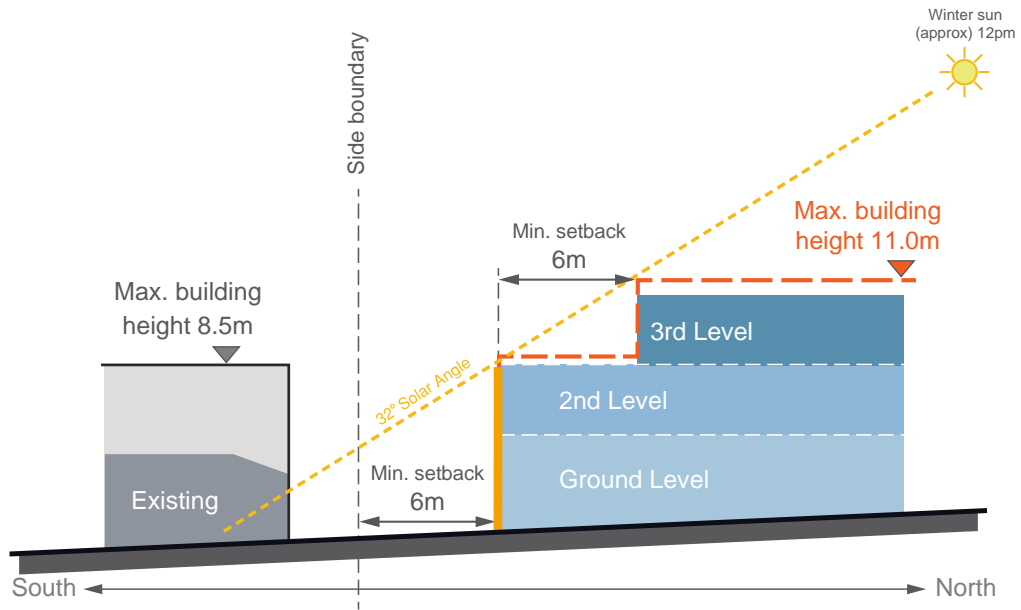

Fig G3.61 Interface section - southern boundary

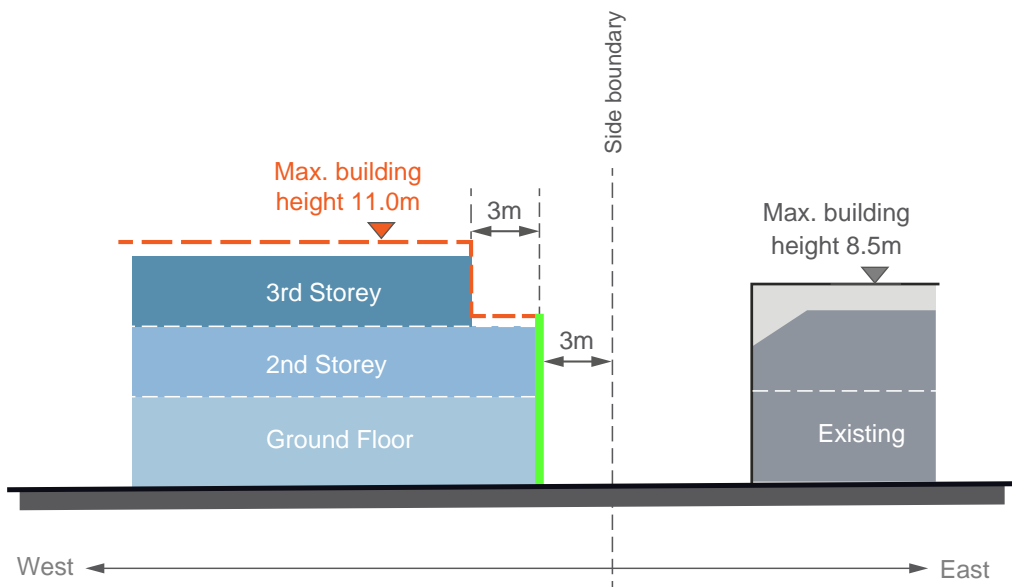

Fig G3.62 Interface section - eastern boundary



# H



## PART H - INDUSTRIAL DEVELOPMENT

|                                       |     |
|---------------------------------------|-----|
| H1 General Objectives .....           | H-2 |
| H2 Setbacks .....                     | H-2 |
| H3 Landscaping .....                  | H-3 |
| H4 Building form and appearance ..... | H-3 |
| H5 Light and noise.....               | H-4 |
| H6 Public Art.....                    | H-5 |

## H1 General Objectives

### Objectives

- O1. To implement the Objectives of the Canada Bay LEP.
- O2. To improve the quality of industrial development within the City of Canada Bay.
- O3. To ensure that industrial development does not unreasonably adversely impact on residential amenity.
- O4. To encourage employee amenity within Industrial areas.
- O5. To facilitate employment generation and maximise the potential of employment generating industries.
- O6. To encourage design that is sustainable and environmentally responsible, and takes into account its social impact on environmental amenity.
- O7. To encourage design that is of a type, scale, height, bulk and character that is compatible with and will enhance the streetscape characteristics of the surrounding area.

## H2 Setbacks

Setbacks play a number of important roles in areas developed for industrial uses. Front, side and rear setbacks ensure space for landscaping, contribute to streetscape consistency and modulate building bulk and scale. Setbacks also provide a transitional area or buffer to adjoining land uses and ensure building entrances are clearly visible

### Objectives

- O1. To encourage design that is in keeping with the streetscape characteristics of the surrounding area.
- O2. To ensure sufficient space for landscaping, on site parking, access, and circulation.
- O3. To modulate the bulk and scale of development.
- O4. To provide a buffer to adjoining land uses, reducing adverse impacts on surrounding land uses and residential amenity.
- O5. To integrate development with the existing street and footpath network.
- O6. To ensure development provides adequate disabled access, wherever possible.

### Controls

|     |   |
|-----|---|
| C1. | The front or road setback of buildings should be consistent with the setback of adjoining buildings. Where the setback of adjoining buildings is inconsistent, the building should be consistent with the dominant setback found along the street.<br><br>In some instances, Council may require a minimum setback of 6.0m, depending on the circumstances of the case. |
| C2. | Front setbacks are to comprise soft landscaping in accordance with the requirements of section F3.  |
| C3. | A minimum side and rear setback of 6.0m is required - 50% of the side setback can be used for off street parking providing the remaining area comprises soft landscaping in accordance with the requirements of section F3.   |
| C4. | Greater setbacks may be required for bulky, hazardous and noise or odour generating activities.   |

### H3 Landscaping

Landscaping provides a setting for development and can contribute positively to the creation of a strong corporate identity. It contributes to the creation of a pleasant working environment for employees and increases the amenity of on-site car parking and storage areas. Landscaping can also play an important buffer role for industrial development that adjoins residential development.

#### Objectives

- O1. To ensure that there is accessible and useable open space for the use of employees.
- O2. To integrate building design, car parking and service facilities with landscaping to achieve a pleasant working environment.
- O3. To protect and enhance the existing landscape character of the City of Canada Bay.
- O4. To improve the visual amenity of industrial development sites and areas.
- O5. To provide robust landscaping within new industrial development that contributes to biodiversity, sustainability, water efficiency and reduction of airborne pollutants.
- O6. To enhance stormwater management by minimising hard non-porous surfaces.

#### Controls

|     |   |
|-----|---|
| C1. | Open space dedicated to the recreational use of employees is to be provided on site within a landscaped setting.  |
| C2. | Front and side setbacks are to be landscaped to soften and screen buildings, storage, service and parking areas.  |
| C3. | Landscaping and fencing should not obscure the main building entry.   |
| C4. | A minimum of 10% of the subject site should be landscaped.  |
| C5. | All security fencing should be located behind the landscaped setback. Council may vary this requirement if it is considered desirable in the circumstances. |
| C6. | All landscaped areas should be supplied with a fully automatic irrigation system.   |
| C7. | All new proposals for industrial development should be accompanied by a landscaping plan prepared by a qualified professional.                              |

### H4 Building form and appearance

Building form and appearance encompasses a number of aspects of building design including amenity, relationship to the streetscape, materials, energy use, and noise mitigation.

#### Objectives

- O1. To ensure the form and scale of development enhances the streetscape and visual quality of the area.
- O2. To encourage innovative, contemporary and sustainable building design.
- O3. To ensure that materials used contribute positively to ecological sustainability.
- O4. To minimise energy use in all parts of buildings.
- O5. To ensure building materials mitigate noise impacts to adjoining development, particularly residential areas.

#### Controls

|     |  |
|-----|--|
| C1. | Building height, mass, and scale should compliment and be in keeping with the character of surrounding and adjacent development.   |
| C2. | Colours should be consistent with the themes of adjoining development and enhance the visual amenity of the industrial area.   |
| C3. | Building entrances should be clearly defined and well articulated through form, materials and colour and provide level or ramped access.   |
| C4. | Buildings should not contain long, blank, and unarticulated walls, particularly on street frontages.   |
| C5. | Buildings should be of a contemporary and innovative design.<br><br>All public frontages should be specially articulated with the use of brick, stone, concrete, glass (non-reflective), and like materials. |

## Public utilities

| Controls |  |
|----------|--|
| C6.      | <p>For new development and substantial alterations to existing premises provision must be made for connection to future underground distribution mains.</p> <p>In such developments the following must be installed:</p> <ul style="list-style-type: none"> <li>• an underground service line to a suitable existing street pole; or</li> <li>• sheathed underground consumers mains to a customer pole erected near the front property boundary (within 1 metre).</li> </ul> <p>Council may require the bundling of cables in the area surrounding the development to reduce the visual impact of overhead street cables.</p> <p>For further details see Energy Australia requirements.</p> |

## H5 Light and noise

It is important to maintain the amenity of adjoining land. Light spillage and noise emissions are two key design considerations.

### Objectives

- O1. To ensure industrial development maintains the amenity of surrounding development.
- O2. To ensure appropriate noise attenuation measures are incorporated into building design and site layout.
- O3. To ensure lighting does not distract or annoy vehicle drivers or the occupants of adjoining properties.

| Controls |  |
|----------|--|
| C1.      | Sources of noise, where practicable, should be sited away from adjoining properties and where necessary, be screened by acoustical treatments. |
| C2.      | High-intensity noise generating industries will not normally be permitted in close proximity to residential uses.                              |
| C3.      | Light sources should be directed away from adjoining residential properties.   |

## H6 Public Art

Public art contributes to place identity and increasingly it is a significant part of the visitor experience. Cities around the world have recognised the value of cultural statements and public art has a key role in giving character and cultural definition to areas. This has been particularly successful in Australia with substantial public art initiatives reactivating waterfronts and urban development. The City of Canada Bay has increasingly used art as part of place making across the City.

### Objectives

- O1. To include public art in communal and public spaces.
- O2. To focus public art on the history and heritage, stories, people, landscape, streetscape, and culture of the place.

### Controls

|     |  |
|-----|--|
| C1. | Consider the City of Canada Bay Public Art Plan and City of Canada Bay Cultural Plan and provide details of public art to be included in communal and public spaces. |
| C2. | Identify locations for mural, integrated artworks, sculptural and lighting projects including hoardings for new developments.  |
| C3. | Coordinate cultural input and community participation into interpretive artworks and public art.   |
| C4. | Use public art, interpretive work, oral histories and industrial artefacts to celebrate the working heritage of Canada Bay's foreshores.                             |
| C5. | Reflect industrial, social and cultural history in the built and natural environment.  |

**This page was intentionally left blank**



## PART I - SIGNAGE AND ADVERTISING

|   |      |
|---|------|
| 11 Signage and Advertising .....  | I-2  |
| 12 General Objectives and standards applicable to all development ..... | I-3  |
| 13 Sign proliferation and dominance .....                               | I-7  |
| 14 Sign dimensions .....  | I-8  |
| 15 Integration .....  | I-8  |
| 16 Conservation areas .....   | I-9  |
| 17 Concord Oval and Drummoyne Oval Signage .....                        | I-10 |
| 18 Architectural amenity and residential character .....                | I-12 |

## 11 Signage and Advertising

The purpose of this section is to ensure signs and advertising structures can be designed and located so they fit into the environment and do not detract from the character of an area.

### The role of signs and advertising structures

Signs and advertising structures:

- are important for business advertising and the creation of a company's corporate image;
- provide information and identification; and
- are used for community purposes such as advertising local events, informing of community services and identifying features of historic interest.

The controls aim to minimise excesses, such as advertisements which are so large they overwhelm buildings and landscaping, or the clutter which results from too many advertisements of different shapes and sizes on one site.

Fewer, simpler and "clean-lined" signs which are well located have greater visual impact, are of greater value to businesses and better for the visual environment.

### Making an application

Council should consider the following matters when dealing with an application to erect an advertising sign:

- a) class of advertising structure, eg. awning sign, fascia sign, roof sign, pole or pylon sign, etc.;
- b) design of the structure;
- c) the siting, location and colour of the structure;
- d) the area of the advertising structure;
- e) the nature of any advertisement intended to be associated with the structure;
- f) the number of advertising structures proposed;
- g) the multiplicity of existing signs;
- h) the architectural qualities, appearance and balance of the building;
- i) the erection of signs without relationship to the function of the premises upon which the sign is to be erected;
- j) the erection of signs without relationship to other signs erected on the premises or other premises within the vicinity;
- k) the visual impact on the local environment; and
- l) the benefit to the community of the proposed advertising signs.



## I2 General Objectives and standards applicable to all development

### Objectives

The siting, location, size, height, scale, design, colour, shape and materials of construction of advertisements should:

- O1. Complement and enhance the predominant character of the locality;
- O2. Complement and enhance any building, structure or site of heritage significance on which it is to be erected or located;
- O3. Not obscure the view of attractive landscapes, streetscapes, or significant buildings; and
- O4. Not adversely affect the safety of traffic or pedestrians.

### Controls

- |     |   |
|-----|---|
| C1. | The minimum controls for all signs are included in Table I-A. |
|-----|---|

### Inappropriate development

#### Controls

- |     |  |
|-----|--|
| C2. | <p>The following signs and advertising structures are not considered to be appropriate:</p> <ul style="list-style-type: none"> <li>a) Signs erected or attached to the sides of buildings where such side is adjacent to residences or residential flat buildings, or where the side of the building faces a residential street unless special circumstances as determined by Council are considered to exist;</li> <li>b) Signs or advertisements other than those relating to the occupier(s) of the building;</li> <li>c) Flashing, moving, or video signs;</li> <li>d) More than one (1) projecting wall sign, flush wall sign or painted wall sign per elevation;</li> <li>e) More than one (1) outward facing sign (eg top hamper, painted or etched window sign) per ground floor shop;</li> <li>f) Signs located on an awning or signs attached above the awning;</li> <li>g) Any sign or signboard exhibited on Council's footpath;</li> <li>h) Signs attached above the roof;</li> <li>i) Permanent inflatable signs;</li> <li>j) Flag pole signs;</li> <li>k) Signs of more than 20m<sup>2</sup> in area or 8.0 metres in height; and</li> <li>l) Private identification signs within the public right of way.</li> </ul> |
|-----|--|

**Table I-A Requirements for signage**

| Type of sign                                       | Maximum size/area and number  | Location/ other requirements  |
|--|---|---|
| Under Awning Sign (Illuminated or non-illuminated) | <ul style="list-style-type: none"> <li>• 2.5m x 0.3m (maximum)</li> <li>• One per shop; or</li> <li>• One every 5.0m provided that distance of not less than 3.0m between the centres of signs on adjoining properties is maintained</li> </ul>   | <ul style="list-style-type: none"> <li>• Erected at right angles to the building</li> <li>• Minimum clearance of 2.6m to footpath</li> <li>• Not to project beyond the awning</li> </ul>  |
| Top Hamper Sign                                    | <ul style="list-style-type: none"> <li>• Restricted to that portion of the shop front above the level of the head of the doorway or window to which it is attached.</li> <li>• Restricted to the underside of the awning</li> <li>• Not illuminated</li> <li>• Where shop front facade comprises full glass, hamper signs will only be permitted behind the glass</li> <li>• One per shop</li> <li>• 2.5m x 0.3m (maximum)</li> </ul> | <ul style="list-style-type: none"> <li>• Not to project more than 20mm beyond the face of the building.</li> </ul>  |
| Pole or Pylon Sign                                 | <ul style="list-style-type: none"> <li>• Max advertising area 4.65m<sup>2</sup></li> <li>• Max height 8.0m</li> <li>• One per site</li> </ul>   | <ul style="list-style-type: none"> <li>• At least 2.6m above ground level and not to project more than 1.2m beyond the street alignment</li> <li>• Only where buildings are remote from the street alignment</li> <li>• A single retail centre and major tenant pylon is permitted along Homebush Bay Drive.</li> </ul> |
| Flush or painted wall sign                         | <ul style="list-style-type: none"> <li>• 5m<sup>2</sup> or 5% of the wall area* up to 100m<sup>2</sup></li> <li>• Maximum of one flush wall sign per elevation</li> <li>• Should not extend beyond wall edges</li> </ul>  | <ul style="list-style-type: none"> <li>• For wall areas* over 100m<sup>2</sup> proposed signs will be considered on a merit basis but should not exceed 7.5% of wall area or a maximum of 30m<sup>2</sup> whichever is the lesser</li> </ul>  |
| Projecting Wall Sign (Vertical) where:             |   |   |
| lowest part of sign is between 2.6m and 3.7m       | <ul style="list-style-type: none"> <li>• 0.6m maximum projection from wall face &amp; maximum 1.8m height</li> </ul>  | <ul style="list-style-type: none"> <li>• Only permitted where no awnings exist on a building</li> <li>• Height of sign should not be less than width</li> <li>• Should be erected at right angles to the face of the building</li> </ul>  |
| lowest part of sign is 3.7m-4.5m                   | <ul style="list-style-type: none"> <li>• 0.7m maximum projection from wall face &amp; maximum 2.4m in height</li> </ul>   | <ul style="list-style-type: none"> <li>• Should provide 2.6m clearance to footpath from underside of sign</li> </ul>  |
| lowest part of sign exceeds 4.6m                   | <ul style="list-style-type: none"> <li>• 0.9m maximum projection from wall face &amp; maximum 3.0m in height</li> </ul>   | <ul style="list-style-type: none"> <li>• Should not extend within 0.6m of the kerb alignment</li> <li>• One per building</li> <li>• Maximum width 0.4m</li> </ul>   |

| Type of sign                             | Maximum size/area and number  | Location/ other requirements   |
|--|---|--|
| Projecting Wall Sign (Horizontal)        | <ul style="list-style-type: none"> <li>Maximum dimensions as follows:               <ul style="list-style-type: none"> <li>1.3m (length) x 0.8m (height) x 0.4m (width) for rectangular signs</li> <li>1.2m x 1.2m for square signs</li> <li>1.2m diameter for round signs</li> </ul> </li> <li>One per building</li> </ul> | <ul style="list-style-type: none"> <li>Only permitted where no awnings exist on a building</li> <li>Height of the sign is less than its width</li> <li>Should be erected at right angles to the face of the building</li> <li>Should provide 2.6m clearance to footpath from underside of sign but not more than 4.0m above footpath</li> <li>Should not extend within 0.6m of the kerb alignment</li> </ul> |
| Multi-Occupancy Buildings                | <ul style="list-style-type: none"> <li>One sign per building for identification</li> </ul>  | <ul style="list-style-type: none"> <li>Under awning signs should meet above requirements for such signs</li> </ul>   |
| Awning fascia sign                       | <ul style="list-style-type: none"> <li>Sign to be painted on or attached to fascia</li> <li>Must not project above or below the awning or the return end of the fascia</li> </ul>   | <ul style="list-style-type: none"> <li>Attached sign must be flat, with minimal projection from the fascia (similar to painting the fascia)</li> <li>Not illuminated</li> </ul>  |
| Window sign                              | <ul style="list-style-type: none"> <li>May be painted or etched onto internal or external surface of window or attached to internal surface of window</li> <li>Maximum 6m<sup>2</sup> or 20% of the surface area of the window, whichever is the lesser</li> </ul>  | <ul style="list-style-type: none"> <li>Must continue to allow passive visual surveillance</li> <li>Not illuminated</li> </ul>  |
| Obscure glazing                          | <ul style="list-style-type: none"> <li>Maximum 6m<sup>2</sup> or 20% of the surface area of the window, whichever is the lesser</li> </ul>  | <ul style="list-style-type: none"> <li>Must continue to allow passive visual surveillance</li> <li>The remainder of the shopfront glazing must remain clear to allow views into and out of the shop</li> </ul>   |
| Home business/ industry/ occupation sign | <ul style="list-style-type: none"> <li>Painted or attached to external wall (ground floor) or fence with minimal projection from surface to which it is attached</li> <li>Not more than one per site</li> <li>1m<sup>2</sup> in area (maximum)</li> </ul>   | <ul style="list-style-type: none"> <li>Not illuminated</li> </ul>  |
| Signs attached above awning              | <ul style="list-style-type: none"> <li>Not permitted</li> </ul>   |  |
| Building identification signage          | <ul style="list-style-type: none"> <li>Building identification signage is the only signage permitted above first floor level.</li> </ul>  |  |
| Roof Sign                                | <ul style="list-style-type: none"> <li>Not permitted</li> </ul>   |  |
| Floodlit Sign                            | <ul style="list-style-type: none"> <li>Not permitted except where special circumstances exist</li> </ul>  |  |

\* Measurement of the wall area does not include the area below awning area or any area obscured by the adjoining property.



Figure I2.1 Types of advertising signs

### 13 Sign proliferation and dominance

The number of signs displayed on any site should be minimised in order to avoid visual clutter, duplication of message and adverse impacts on the amenity of adjacent areas from which the signs are visible.

**Refer to Figure I3.1**

**Objectives**

- O1. To minimise the proliferation of signs and visual clutter.
- O2. To ensure signs are clearly visible without dominating buildings or streets.

| Controls |   |
|----------|---|
| C1.      | Signs, other than those relating to the occupier of the building are not permitted.   |
| C2.      | Maximum size/area and number are included in Table I-A.   |
| C3.      | The number of advertisements displayed on any site should be minimised in order to avoid visual clutter and duplication of message. |
| C4.      | Signs should be designed to provide clear property and business identification without dominating the site or the streetscape.      |
| C5.      | Signage should be visually sub-ordinate to the building as a whole and its façades.   |
| C6.      | In multi-tenanted buildings, a single coordinated free-standing advertisement or directory board should be used.                    |
| C7.      | Signage must be designed to avoid confusion with directional and traffic signs.   |
| C8.      | Signage should be designed to add character to the street and complement the architecture.  |
| C9.      | To minimise visual clutter, signage should be integrated with awnings.  |



Undesirable sign dimensions



Preferred sign dimensions

Figure I3.1 Undesireable and preferred sign dimensions

## 14 Sign dimensions

Signs should be designed to provide clearly identifiable business identification without dominating the appearance of the site or streetscape.

### Objectives

- O1. To ensure signs do not dominate buildings or streetscape and are in keeping with the character of the surrounding area.

| Controls |   |
|----------|---|
| C1.      | Maximum size/area and number are included in Table I-A.   |
| C2.      | The supporting structure of free-standing advertisements should be of dimensions which provide good visual balance to the structure in addition to the necessary structural supports. |
| C3.      | Supporting structures should not dominate the sign, building or streetscape.  |
| C4.      | Free standing signs and advertisements on multi-tenanted buildings should be limited to one per building.   |

## 15 Integration

Signs and advertising structures are valuable in providing information, identification and warning. Signs need to be clearly visible. Signs and advertising structures should be sensitively sited and designed so they are well integrated with building and landscape design to minimise adverse impacts on streetscape and urban character.

### Objectives

- O1. To ensure signs are well located and integrated with building and landscape design where possible.

| Controls |   |
|----------|---|
| C1.      | Signs attached to buildings should be of appropriate colour, scale and proportion, and of an integrated design that is coordinated with the architectural form and design of the building upon which the advertisement or advertising display is located.   |
| C2.      | Free-standing advertisements should not rely upon the removal of trees or lopping of branches in order to be visible.   |
| C3.      | To achieve durability, signage and advertising should be constructed of non-combustible materials and be resistant to vandalism.  |
| C4.      | To minimise visual clutter, the source of light to illuminated signage should be concealed or integral with the sign. Electrical conduits to illuminated signs including neon signs should be concealed. The ability to adjust the light intensity is required. A curfew on illumination may be imposed to protect the residential amenity of nearby residential development. |

## 16 Conservation areas

Outdoor advertising should be designed and located in a manner which conserves the character and heritage significance of the building, street or area which have been identified as significant. Generally, signs on individual buildings or within conservation areas should be sensitively designed and located and should complement the building or area.

### Objectives

- O1. To ensure signs associated with heritage buildings are sensitively designed and located.
- O2. To ensure signs do not detract from the appearance and character of Conservation Areas.

| Controls |  |
|----------|--|
| C1.      | Signs and advertising structures should be designed and located in a manner which conserves or enhances heritage places and buildings, and the appearance and character of conservation areas. |
| C2.      | New signs should not be placed on the side of buildings.   |
| C3.      | Signs should observe traditional sign locations, and wherever possible original signs should be retained and conserved at the site.  |
| C4.      | Signs should not break the historic parapet or roofline.   |
| C5.      | Signs should temper modern advertising styles with sympathetic design details (eg. sympathetic colours, margins, type, style) without trying necessarily to recreate a “historic” theme.       |
| C6.      | Proponents should demonstrate through research that the advertising proposal is in keeping with the historic building or place.  |
| C7.      | Illuminated signs should not be placed on heritage items or in conservation areas.   |
| C8.      | Signs should be constructed with a high standard of materials and graphics.  |
| C9.      | Signs should be minimalist in their scale and design.  |



Undesirable sign dimensions



Preferred sign dimensions

Figure I6.1 Undesireable and preferred signs for conservation areas

Refer to Figure I6.1

## 17 Concord Oval and Drummoyne Oval Signage

Council recognises the need for corporate and community sponsorship of sporting groups in the local area. At the same time, it acknowledges the need to ensure that the appearance and amenity of the natural built environment of the reserves and surrounding areas is protected.

Signage approval is valid for the term stated in the consent. After this time, applicants must reapply to Council for approval to erect sponsorship signage.

### Objectives

- O1. To allow sponsorship signage for community based sporting clubs in locations and a manner that complements the role of the reserves.
- O2. To control the display of advertising material in such a manner as will reasonably protect the amenity of the local area.
- O3. To ensure that sponsorship signage is directly related to the reserve/sporting facility in which it is displayed.
- O4. To coordinate the placement of signage on reserves and associated facilities to minimise clutter, avoid unnecessary duplication and improve the reserves attractiveness and function.

### Location of sponsorship signs

#### Controls

C1. Signage is to be located so as to be visible only to persons attending the organised sports activities on the reserve and should not face outward (Figure 17.1).

The protection of views into and within public areas is to be maintained and enhanced.

Signage is only permitted on fencing around the sporting field. Applications for signage on grandstands and scoreboards at Concord and Drummoyne ovals will be considered based on merit assessment.

Signage on perimeter fences shall face inwards towards the sporting facility and shall be restricted to the height of the fence surrounding the sporting field.

Where the rear side of the sign is visible from any road, street or waterway, the rear side shall be treated in a manner so as to blend with the existing fence structure.

The visibility of the signage from the surrounding roads, streets, waterways or residential areas is to be minimised.



**Design and content of sponsorship signs**

| Controls |   |
|----------|---|
| C2.      | <p>Illuminated, animated, flashing or moving signs are not permissible.</p> <p>No signage is to be painted directly onto a fence or other structure.</p> <p>All signage must include the sporting clubs name on at least 25% of the overall area of the sign.</p> <p>Signage content is restricted to information about the sponsors of the teams or organisations using the sporting facility or about the products of those sponsors.</p> <p>Where permissible, signage on scoreboards, grandstands etc, shall not exceed the width of the structure by more than 1 metre. No signs are to extend above the existing height of the structure.</p> <p>Signage is not to contain any advertisements for cigarettes.</p> |

**General**

| Controls |   |
|----------|---|
| C3.      | <p>The applicant is to be responsible for maintaining signage in a good state of repair.</p> <p>All sporting bodies and advertisers are to be made aware that signs may be removed or covered up during special “one off” events.</p> |

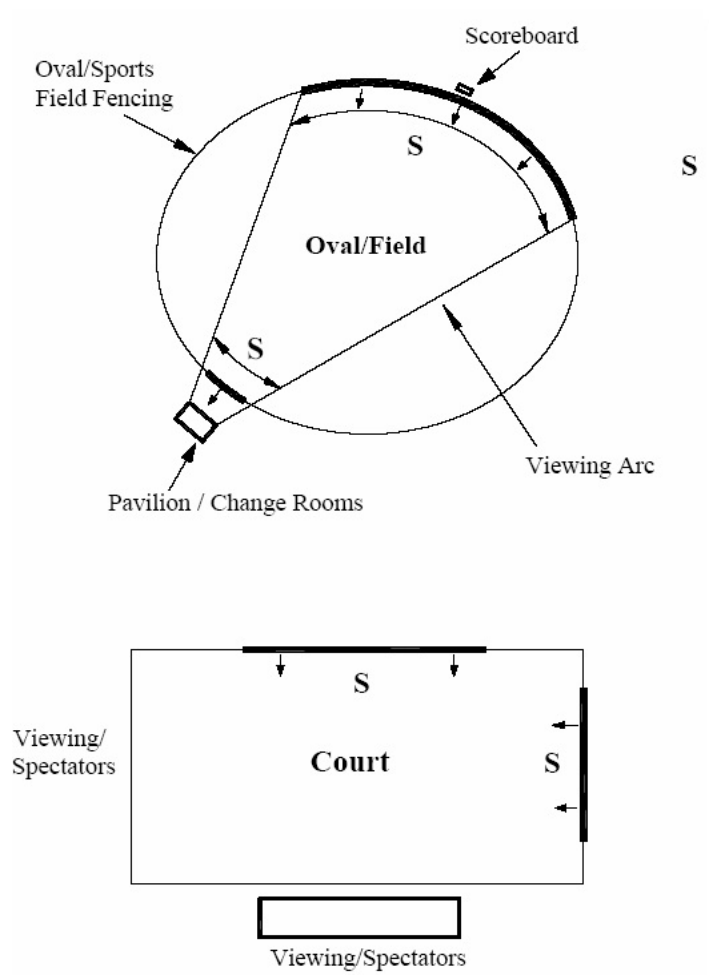

Figure 17.1 Location criteria for signage

Key: Section of fence suitable for permanent signage. Signs to face Pavilion or viewing area. Signage must not be visible from outside the reserve.

Note: The locational criteria apply to tennis courts, lawn bowls and other relevant recreation facilities within the Council Reserve system.

## 18 Architectural amenity and residential character

The scale of advertising signs should be compatible with the buildings they are on as well as with nearby buildings and other existing signs. Many traditional building designs can be easily broken into a grid based on the alignments of the parapet (skyline), cornice, verandah, window and door.

Appropriate dimensions are often achieved by restricting signs to grid locations or panels. This ensures that the original architectural character (set by the lines of awnings, window and door openings, parapet lines and setbacks) remains dominant.

### Objectives

- O1. To ensure signs and advertising structures respect the architectural character of the building and the locality.
- O2. To ensure the location of signs maintains and protects the amenity of residential areas.

### Controls

|     |   |
|-----|---|
| C1. | The scale of advertising signs should be compatible with the buildings they are on, nearby buildings, street widths and other existing signs.   |
| C2. | On buildings with decorative facades, signs should not be placed on the decorative forms or mouldings. Instead they should appear on the undecorated wall surfaces, unless architecturally designed sign panels are provided. |
| C3. | To protect residential amenity, advertising signage is not permitted facing private residential streets, or on side walls abutting residential properties.  |



## PART J - CHILD CARE CENTRES

|                               |     |
|-------------------------------|-----|
| J1 Child Care Centres .....   | J-2 |
| J2 Building setbacks .....    | J-2 |
| J3 Provision of parking ..... | J-2 |
| J4 Signage .....              | J-2 |

## J1 Child Care Centres

The aim of this section of the DCP is to support the planning controls provided within the State Environmental Planning Policy (Educational Establishments and Child Care Facilities) 2017 and achieve appropriate development of Child Care Centre within each land use zone.

### Objectives

To ensure that Child Care Centres:

- O1. Are compatible with neighbouring land uses;
- O2. Integrate into existing residential environments and are unobtrusive in terms of size, bulk and height;
- O3. Are appropriate for the surrounding built form and natural landscape;
- O4. Will have minimum impact on surrounding land uses; and
- O5. To ensure the health, safety and wellbeing of children and staff in Child Care Centres.

## J2 Building setbacks

### Objectives

- O1. To ensure the height and scale of a child care centre relates to site conditions, complements the prevailing character of the streetscape and minimises any adverse amenity impacts upon the surrounding properties.
- O2. To ensure the appearance of the development enhances the streetscape.

#### Controls

- |     |  |
|-----|--|
| C1. | <p>The Child Care Centre should comply with the relevant setback controls as stipulated in the Canada Bay Development Control Plan as follows:</p> <ul style="list-style-type: none"> <li>• Within a residential zone, setbacks for dwelling houses; and</li> <li>• Within a commercial / industrial zone – setbacks will be considered on a merit basis.</li> </ul> |
|-----|--|

## J3 Provision of parking

### Objectives

- O1. To ensure the adequate provision of car parking.

#### Controls

- |     |   |
|-----|---|
| C1. | One (1) car parking space is to be provided for every four (4) licensed places at the Child Care Centre.                        |
| C2. | A designated space is to be provided for disabled parking/service vehicles close to the main entrance of the child care centre. |

## J4 Signage

### Objectives

- O1. Complement and enhance the predominant character of the locality;
- O2. Not obscure the view of attractive landscapes, streetscapes, or significant buildings; and
- O3. Not adversely affect the safety of traffic or pedestrians.

#### Controls

- |     |   |
|-----|---|
| C1. | <p>For Child Care Centres in residential zones, advertising should be limited to not more than one sign per Child Care Centre which</p> <ol style="list-style-type: none"> <li>a) Has a maximum area of 0.5m<sup>2</sup>; and</li> <li>b) Serves only to identify the name and phone number of the Child Care Centre and the hours of operation.</li> </ol> |
| C2. | For Child Care Centres in all other zones, compliance should be achieved with Council's signage requirements.   |



## PART K - SPECIAL PRECINCTS

|   |       |
|---|-------|
| K1 Land to which Part K applies .....                               | K-2   |
| K2 Abbotsford Cove .....  | K-3   |
| K3 Bibby Street .....   | K-7   |
| K4 Breakfast Point .....  | K-9   |
| K5 Cape Cabarita .....  | K-49  |
| K6 Concord West .....   | K-57  |
| K7 Edgewood and Kendall Inlet (former Dulux site).....              | K-73  |
| K8 27 George Street North Strathfield.....                          | K-78  |
| K9 186 Great North Road, Five Dock.....                             | K-82  |
| K10 2A Hythe Street, Drummoyne.....                                 | K-88  |
| K11 Kings Bay (former Hycraft site), Five Dock .....                | K-92  |
| K12 Liberty Grove .....   | K-96  |
| K13 Mortlake Point.....   | K-99  |
| K14 Pelican Point, Pelican Quays and Philips Landing, Concord ..... | K-103 |
| K15 Rhodes Corporate Park .....                                     | K-106 |
| K16 Rhodes East .....   | K-111 |
| K17 Rhodes West .....   | K-201 |
| K18 Sydney Wire Mill site, Chiswick.....                            | K-291 |
| K19 Tuscany Court .....   | K-296 |

# K1 Land to which Part K applies

Part K applies to the land identified in Figure K1-1

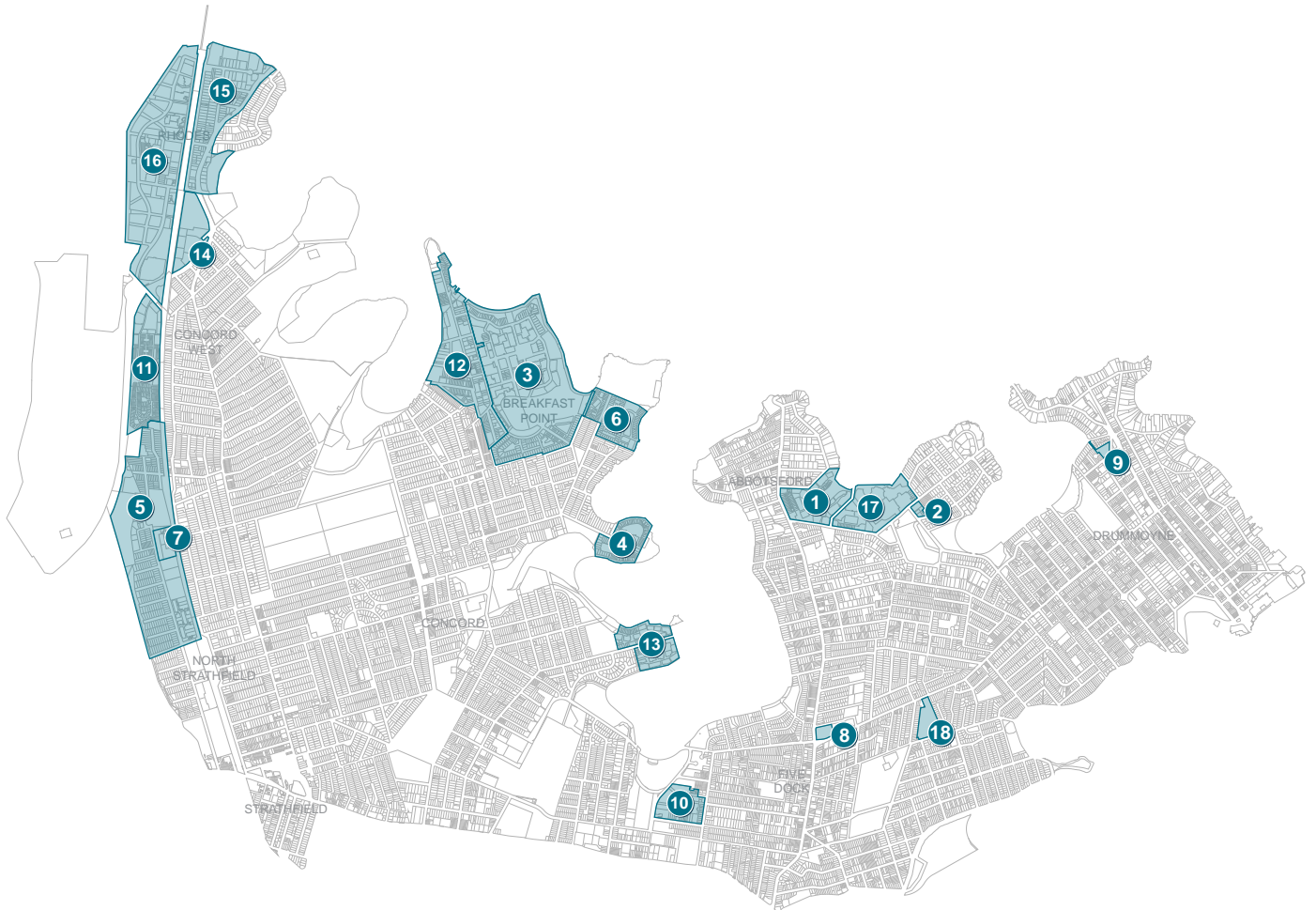

- |  |  |
|--|--|
| 1 Abbotshurst Cove                               | 11 Liberty Grove   |
| 2 Bibby Street                                   | 12 Mortlake Point  |
| 3 Breakfast Point                                | 13 Pelican Point, Pelican Quays and Philips Landing, Concord |
| 4 Cape Cabarita                                  | 14 Rhodes Corporate Park                                     |
| 5 Concord West                                   | 15 Rhodes East   |
| 6 Edgewood and Kendall Inlet (former Dulux site) | 16 Rhodes West   |
| 7 27 George Street North Strathfield             | 17 Sydney Wire Mill site, Chiswick                           |
| 8 186 Great North Road, Five Dock                | 18 Tuscany Court   |
| 9 2A Hythe Street, Drummoyne                     |  |
| 10 Kings Bay (former Hycraft site), Five Dock    |  |

Figure K1-1 Special Precincts overview map

## K2 Abbotsford Cove



Figure K2-1 Aerial photo (source: nearmap.com)



Figure K2-2 Council area map



Figure K2-3 Abbotsford Cove - Location Plan

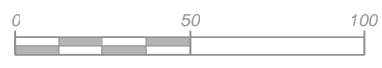

## K2.1 General objectives

- O1. To encourage and facilitate development on the site which, in terms of scale, bulk, form and character: reflects the physical context of the site; is sympathetic to surrounding residential development; and does not dominate the landscape;
- O2. To retain and incorporate existing significant buildings and trees and other site features, creating a sense of place and respecting the heritage values of the site;
- O3. To minimise the impact of the development in terms of overlooking, loss of view and loss of sunlight from adjoining and neighbouring properties;
- O4. To provide unrestricted public access to the foreshore and to the central area of public open space located between Abbotsford House and the Bay;
- O5. To provide for the active and passive recreation needs of the residents of the development which should include the rehabilitation of the Clubhouse pavilion and incorporate recreation facilities such as a swimming pool and tennis courts; and
- O6. To provide a publicly accessible street network as an extension of the existing street network.

## K2.2 Specific provisions

### Design, Scale and bulk

| Controls |   |
|----------|---|
| C1.      | To achieve a development outcome which, in terms of its design, scale and bulk, responds in a sympathetic and harmonious manner to the site, the bay and surrounding residential development. |
| C2.      | To control the externalities of any future development and ensure that future residents of the site enjoy a high standard of amenity and environmental quality.                               |

The height of buildings, including any car parking levels should comply with the height limits for the five residential precincts specified in Figure K2-5 Precinct, Setbacks and Height Control Plans and detailed below:

### Great North Road Precinct

| Controls |  |
|----------|--|
| C3.      | The 7.5m height limit is compatible with the existing residential development on Great North Road. |

### Blackwall Point Road Precinct

| Controls |  |
|----------|--|
| C4.      | The 11m height limit allows 4 levels of residential development above existing ground level. This height has been determined by considering the height and location of existing vegetation, the slope of the land and proximity to Abbotsford House. |
| C5.      | On the Blackwall Point Road frontage a 9m setback to accommodate the root systems of existing vegetation will be necessary. The buildings will also be effectively screened from neighbouring development by the existing stand of weepy fig trees.  |

### Melrose Crescent Precinct

| Controls |  |
|----------|--|
| C6.      | The 16.5m height limit takes into consideration: the substantial fall of the site along the eastern boundary, the height of existing buildings on the site, the location next to the Lysaght site and portion of unmade road (Melrose Crescent) creating an opportunity for a buffer area. |
| C7.      | A 45° envelope control for development, where the Melrose Crescent Precinct adjoins the Open Space Precinct (see Figure K2-4 Indicative 45° Building Envelope) will ensure minimal impact when viewed from the water.  |



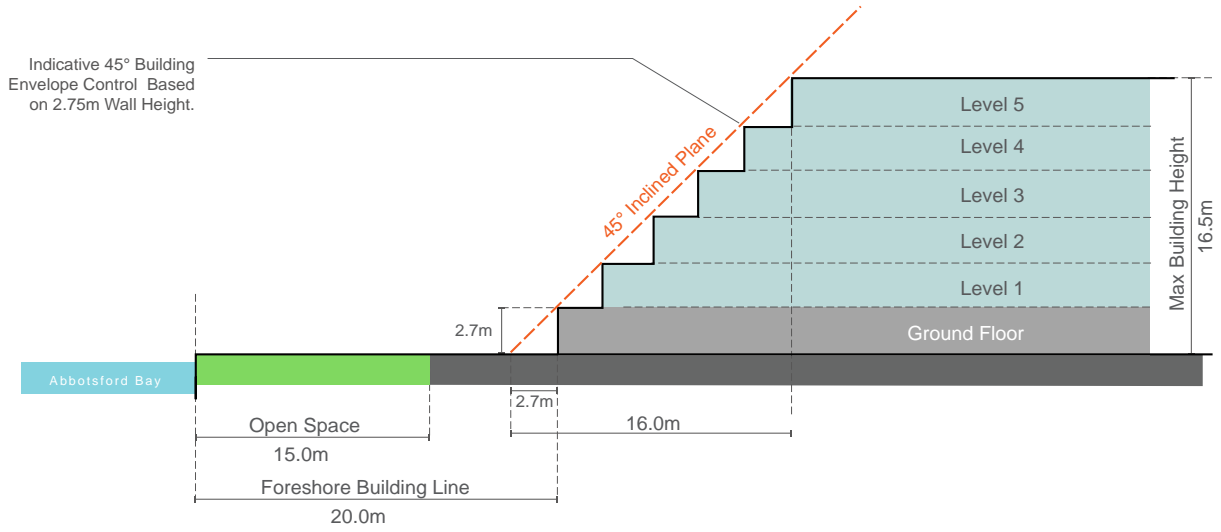
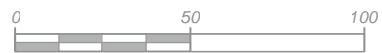

Figure K2-4 Indicative 45° Building Envelope



Figure K2-5 Precinct, Setbacks and Height Control Plans



### Walton Crescent Precinct

| Controls |  |
|----------|--|
| C8.      | The 11m height limit together with the 9m setback will provide for development which will read as 1/2 storeys from Walton Crescent.  |
| C9.      | A 45° envelope control for development where the Walton Crescent Precinct adjoins the Open Space Precinct (see Figure K2-4 Indicative 45° Building Envelope) will ensure minimal impact when viewed from the water and from Walton Crescent. |

### Abbotsford House Precinct

| Controls |   |
|----------|---|
| C10.     | The 7.5m height limit complements Abbotsford House and provides an appropriately scaled edge to the open space. |

### Open Space Precinct

| Controls |  |
|----------|--|
| C11.     | Any structure located in the Open Space Precinct should not exceed 3.6m in height. |

### Site coverage

| Controls |   |
|----------|---|
| C12.     | Buildings must occupy less than 30% of the site area. |

### Setbacks

| Controls |   |
|----------|---|
| C13.     | A 20m Foreshore Building Line applies to the site (see Figure K2-4 Indicative 45° Building Envelope).   |
| C14.     | A 9m building setback applies to parts of the Blackwall Point Road and the Walton Crescent Precincts (see Figure K2-5 Precinct, Setbacks and Height Control Plans). |
| C15.     | Any building to be located near to an existing tree must take account of the drip lines and root systems of that tree.  |

### Design and Form

| Controls |  |
|----------|--|
| C16.     | A 45° building envelope control will control building form on the Abbotsford Bay edge of Melrose Crescent Precinct and Walton Crescent Precinct to minimise impact of the development when viewed from the water (see Figure K2-4 Indicative 45° Building Envelope). |

### Landscaped and Open Spaces

#### Objectives

- O7. To provide for public and private open space that meets user requirements for recreational and social activities and for landscaping;
- O8. To ensure that significant trees are retained or where possible relocated on the site; and
- O9. To assist on-site drainage by the provision of at ground landscaped open space.

| Controls |   |
|----------|---|
| C17.     | To ensure adequate provision of open space maximum permissible site coverage of buildings over the entire site is 30%.  |
| C18.     | Landscaped areas should generally be dominated by vegetation and not masonry elements. Hard paved areas should, where possible, be kept to a minimum in order to reduce stormwater runoff, although wheelchair access must be considered. |

### K3 Bibby Street



Figure K3-1 Aerial photo (source: nearmap.com)

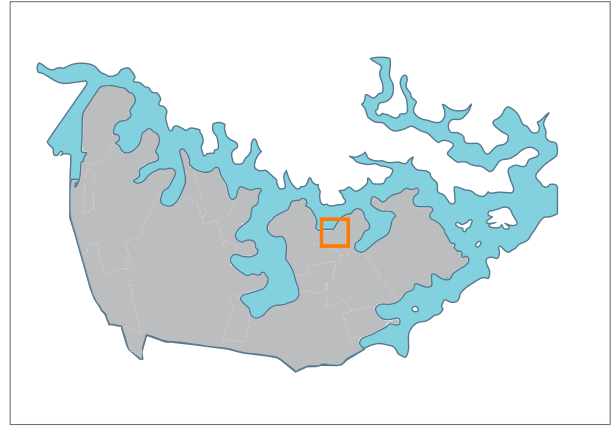

Figure K3-2 Council area map



Figure K3-3 Bibby Street Precinct - Location Plan



The following objectives and controls have been created to ensure an appropriate form and scale of development is provided for the former industrial precinct bound by Bibby Street, Blackwall Point Road and Burns Crescent, Chiswick.

### K3.1 Objectives and provisions

#### Built form and scale

##### Objectives

- O1. Orientate new buildings to the north so as to maximise solar access for new dwellings;
- O2. Build to the building envelope line at the Bibby Street/Blackwall Point Road and Bibby Street/Burns Crescent corners of the site to create a higher density residential “node” complementing existing development on the adjacent corners of the Bibby Street/Blackwall Point Road intersection;
- O3. Establish a continuous building line along Bibby Street;
- O4. Protect the solar access and privacy of existing neighbouring properties and respond to the topography and slope of the study area by establishing building height limits which “step down” the slope of the site; and
- O5. Relate to the existing low density residential properties by “stepping down” the height and scale of new buildings towards the north east of the site.

| Controls |  |
|----------|--|
| C1.      | The maximum number of storeys permitted on the site is shown in Figure K3-4 Maximum Heights.                     |
| C2.      | The minimum boundary setbacks are shown in Figure K3-5 Access and setbacks.                                      |
| C3.      | Vehicle Access points are to be provided in accordance with Figure K3-5 Access and setbacks.                     |
| C4.      | Fencing on the site is to be designed so that sight lines for both pedestrians and vehicles are not obscured.    |
| C5.      | Roof forms, plant and lift overruns are to be designed to be simple compact forms that are visually unobtrusive. |

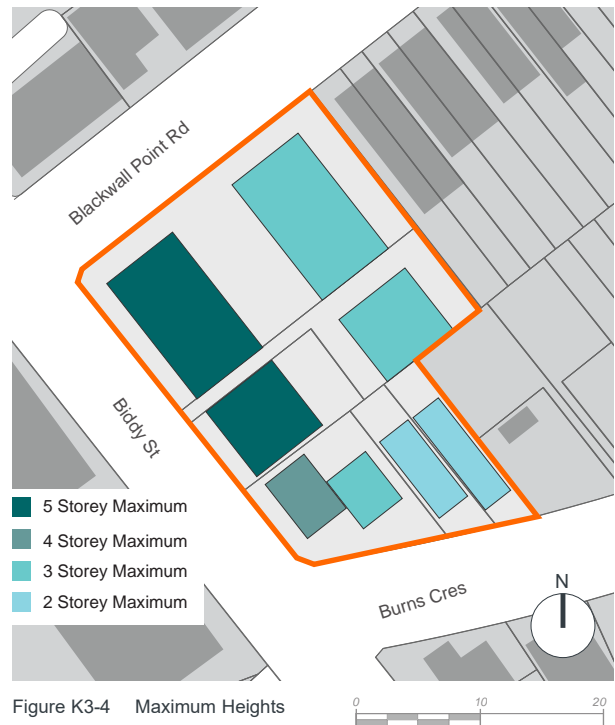

Figure K3-4 Maximum Heights

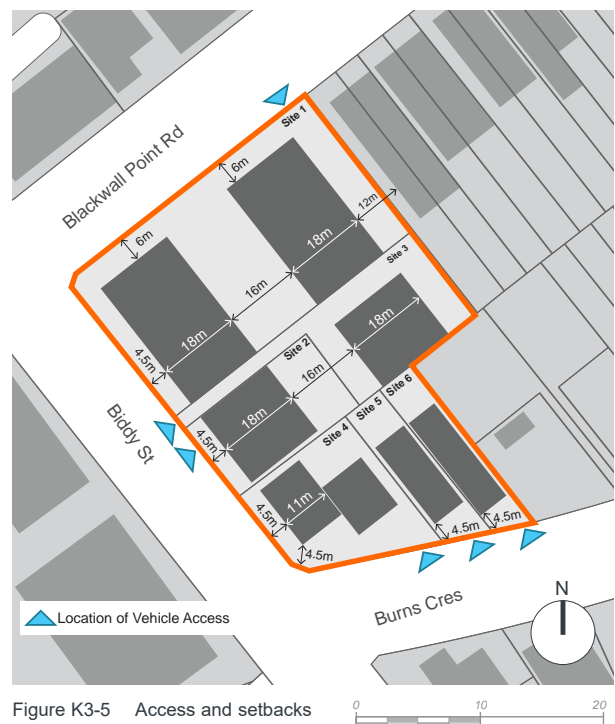

Figure K3-5 Access and setbacks

# K4 Breakfast Point



Figure K4-1 Oblique aerial photo (source: nearmap.com)

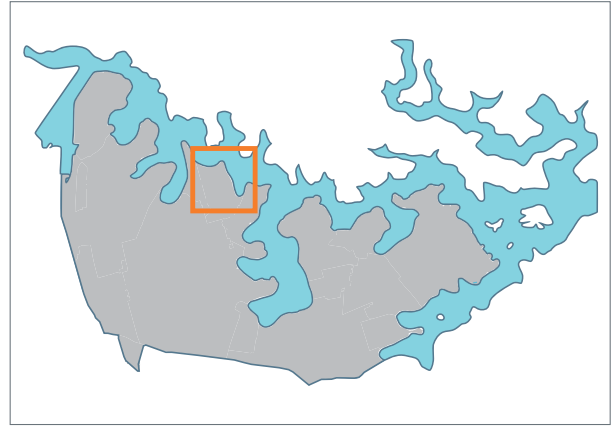

Figure K4-2 Location within LGA



Figure K4-3 Location Plan

### K4.1 Introduction

Breakfast Point is a 51.82 hectare master-planned residential development on a waterfront remediated industrial site 9km west of Sydney CBD, in the City of Canada Bay. Breakfast Point is predominantly a Community Scheme development. Only houses fronting 'perimeter' streets beyond the AGL site are not within a Community Scheme.

The AGL site, Breakfast Point, is a Schedule 2 site of Strategic Significance under State Environmental Planning Policy No 56 (SEPP 56). Under the provisions of SEPP56 Canada Bay City Council (CBCC), in conjunction with the developer, prepared the Breakfast Point Master Plan 2002. Council adopted this plan 3 September 2002 after receipt of the Director Generals concurrence.

The objectives and controls contained within this Part are a result of a consolidation of the following plans:

- Breakfast Point Master Plan 2002
- Breakfast Point Concept Plan 2005 (amended 2013), Issue 8, 22 November 2013
- Single Dwellings on Lots at Breakfast Point DCP

### History and characteristics

The Breakfast Point site was previously the AGL gas works. It was the primary coal gas producing site providing the energy needs of Sydney for over 100 years. With the introduction of natural gas, coal gas production ceased and the site ended its industrial life.

The subsequent remediation action plan (RAP) clean-up resulted in all the vegetation, and all the soil and significant portions of the underlying bedrock, being removed from the site. The site was subject to extensive re-shaping with the remediation program. All replacement soil and re-vegetation was subject to certified consistency with the Landscape Masterplan.

The site has extensive water-frontage to the north and east and higher land to the south and west. It is well protected from cold winter winds and benefits from cooling summer sea breezes. The land has a highly desirable residential orientation with good opportunities for incorporating passive ESD principles.

### K4.2 Desired future character

Breakfast Point establishes a new community within an 'urban village' which embodies the principles of traditional neighbourhoods. The precinct positively relates new development to its urban context and achieves a transition to existing residential areas.

Access and open space linkages connect to the surrounds and the network of pathways for pedestrians and cyclists throughout the site encourages active transport. The precincts' waterfront location is celebrated through the creation, retention and enhancement of vistas and physical connections to the Parramatta River.

A continuous foreshore shared path along the waterfront maximises public access to the waterfront. Large areas of open space such as the Village Green, the area surrounding the Country Cub facility and Silkstone Park further add to the amenity of the precinct. The Village Centre to the west of the site offers convenience retail services, and various facilities and focal points are available for community use.

The range of dwelling types from lower scale detached houses to medium and higher rise apartment buildings offers a diverse choice of housing. Built form addresses and defines streets and open spaces, and the adaptive reuse of heritage items provides a connection to the site's past as the AGL gasworks.



Medium rise building typology in a landscaped setting

### K4.3 General objectives

The following principles are a summarised version of the site planning principles contained in the Breakfast Point Masterplan (2002):

- O1 To establish a new community within an urban village which embodies the principles of traditional neighbourhoods.
- O2 To positively relate new development to its urban context and achieve a transition to existing residential areas.
- O3 To provide a high level of continuity to the surrounds through access links, built form, landscape and open space linkages.
- O4 To provide safe and convenient access to and through the site for all users and to establish a hierarchy of streets which respond to different types of circulation.
- O5 To create a network of pathways for pedestrians and cyclists throughout the site.
- O6 To ensure the creation, retention and enhancement of significant vistas to and from the site, and to and from the Parramatta River.
- O7 To maximise views, access and connection to the waterfront.
- O8 To ensure that the views of the site from the street and the harbour form a harmonious vista which includes vegetation in harmony with the buildings and view corridors.
- O9 To achieve quality urban design with high levels of amenity at the street level and create a sense of community.
- O10 To provide a variety of community focal points with different characters and functions.
- O11 To provide significant areas of parkland providing easy access for the community to the waterfront.
- O12 To provide a choice of residential dwellings in a variety of forms.
- O13 To give definition to the public domain by ensuring buildings address the streets and give form to open spaces.
- O14 To conserve heritage items with compatible uses and ensure adjacent development is of sympathetic scale and character.
- O15 To provide a village centre which includes a convenience shopping centre, shops and services for the community and surrounds.

### K4.4 Access, parking and circulation

#### Objectives

- O16 To provide a co-ordinated access and circulation network designed to conveniently and safely serve the Breakfast Point community in terms of pedestrian movement, bicycles, public transport, service and emergency vehicles, private motor vehicles and car parking.
- O17 To connect and integrate the network with the existing external network.
- O18 To minimise and equably share any impacts on the residential amenity of the surrounding community.
- O19 To provide a level of public access and permeability comparable to that existing in the adjacent residential neighbourhood.
- O20 To facilitate increased public access to the foreshore.
- O21 To minimise hardstand area and potential surface run-off and maximise potential stormwater absorption and area available for soft landscape treatment.

Figure K4-4 Access & Circulation Principles shows the primary access and circulation network established at Breakfast Point.

#### Site Access

##### Controls

- |     |   |
|-----|---|
| C7. | <p>Public vehicle access points to Breakfast Point are to be from:</p> <p><i>Tennyson Road:</i></p> <ul style="list-style-type: none"> <li>• at the main gates of the AGL works;</li> <li>• approx. 150 metres north of the Emily Street intersection;</li> <li>• opposite Whittaker Street; and</li> <li>• at the existing gateway in vicinity of Northcote Street.</li> </ul> <p><i>Kendall Street:</i></p> <ul style="list-style-type: none"> <li>• at the intersection of Bishop and Medora Streets</li> </ul> <p><i>Emily Street:</i></p> <ul style="list-style-type: none"> <li>• via Adams Street from Brays Road</li> </ul> <p><i>Medora Street:</i></p> <ul style="list-style-type: none"> <li>• opposite Medora Lane</li> </ul> |
|-----|---|

## Internal Road Hierarchy

| Controls |  |
|----------|--|
| C8.      | The road hierarchy is planned around development blocks or precincts described by a network of 'open access way' roads connecting to the external public road system. Each development site will have access to the public road system via open access ways. |
| C9.      | All roads are community owned and maintained.  |

## Public Access

| Controls |   |
|----------|---|
| C10.     | All Breakfast Point internal streets are 'open access' ways under the Community Land and Management Act. 'Open access' ways are effectively 'public space' under the Local Government Act 1993. |
| C11.     | Open access ways can be considered as 'public roads' with the exception that the Community Association, not the Council, is responsible for maintenance.  |
| C12.     | Private Access Ways are provided where the function is for purely resident or service access to a distinct development or building. Private access roads may have restricted public access.     |

## Traffic Calming

| Controls |  |
|----------|--|
| C13.     | Contained carriageway widths, surfaces, street geometry and landscaping are to be the primary traffic calming devices in the design of access streets. |
| C14.     | Speed humps, chicanes and similar devices are not to be used.  |
| C15.     | Roundabouts, where required, are to be designed to accommodate buses and large rigid trucks, and should incorporate landscape beautification.          |

## Road Standards

| Controls |  |
|----------|--|
| C16.     | AMCORD, Australian Standards and Council requirements are the guiding principles in the detail design of roads.<br><br>The achievement of urban design objectives, on-street parking, heritage preservation and other considerations may determine standards varying from AMCORD guidelines. |

## Public Transport

| Controls |  |
|----------|--|
| C17.     | A bus route is to pass within 400m (approx 5 minutes walk) of any dwelling. The collector link and foreshore connector roads are designed to accommodate bus services.                         |
| C18.     | A ferry terminal is to be integrated into the existing pier and accommodate convenient access to people with disabilities.   |
| C19.     | A bus stop is to be provided on the foreshore connector road approximately 75m from the pier.  |
| C20.     | Commuter parking is to be provided with convenient access to the pier precinct. Parking provision is to be sufficient to cater for other water and land based activities in the pier precinct. |



## Pedestrian Movement

### Foreshore Access

| Controls |  |
|----------|--|
| C21.     | A combined public pedestrian/ cycleway is to be provided linking the northern end of Tennyson Road and Cabarita Park on a foreshore strip of land in public ownership.               |
| C22.     | Open access connections to the foreshore public open space are generally no greater than 200m apart.   |
| C23.     | The design of foreshore access system is to consider maintenance and emergency vehicle use.  |
| C24.     | Open access way streets are to include pedestrian footpaths to provide for public pedestrian movement within the site and connections to the external network, and to the foreshore. |
| C25.     | Provision for through-block links are to be made where necessary for reasonable convenience.   |

### Cycleways

| Controls |   |
|----------|---|
| C26.     | Combined pedestrian/ cycleway paths are to be provided to open space areas in accordance with Council's policy. |
| C27.     | Combined pedestrian-cycle paths are to be provided to the collector link and foreshore connector link.          |
| C28.     | Residential access streets are to be cycle shareways.   |

## Emergency and Service Vehicle Access

| Controls |  |
|----------|--|
| C29.     | The road network is to be designed to facilitate emergency and service vehicle access.   |
| C30.     | Large sized trucks must be able to safely negotiate to within 20m of every building.   |
| C31.     | Roads and turning areas are to be designed to discourage reversing movements.  |
| C32.     | Wherever possible loop access roads are to be used. Cul-de-sacs are to incorporate the minimum turning circle of large rigid trucks. |

## Sustainable Development

| Controls |  |
|----------|--|
| C33.     | All roads and movement systems are to be designed to minimise hardstand area and surface run-off, and to maximise the area available for soft landscape treatment and its potential stormwater absorption. |

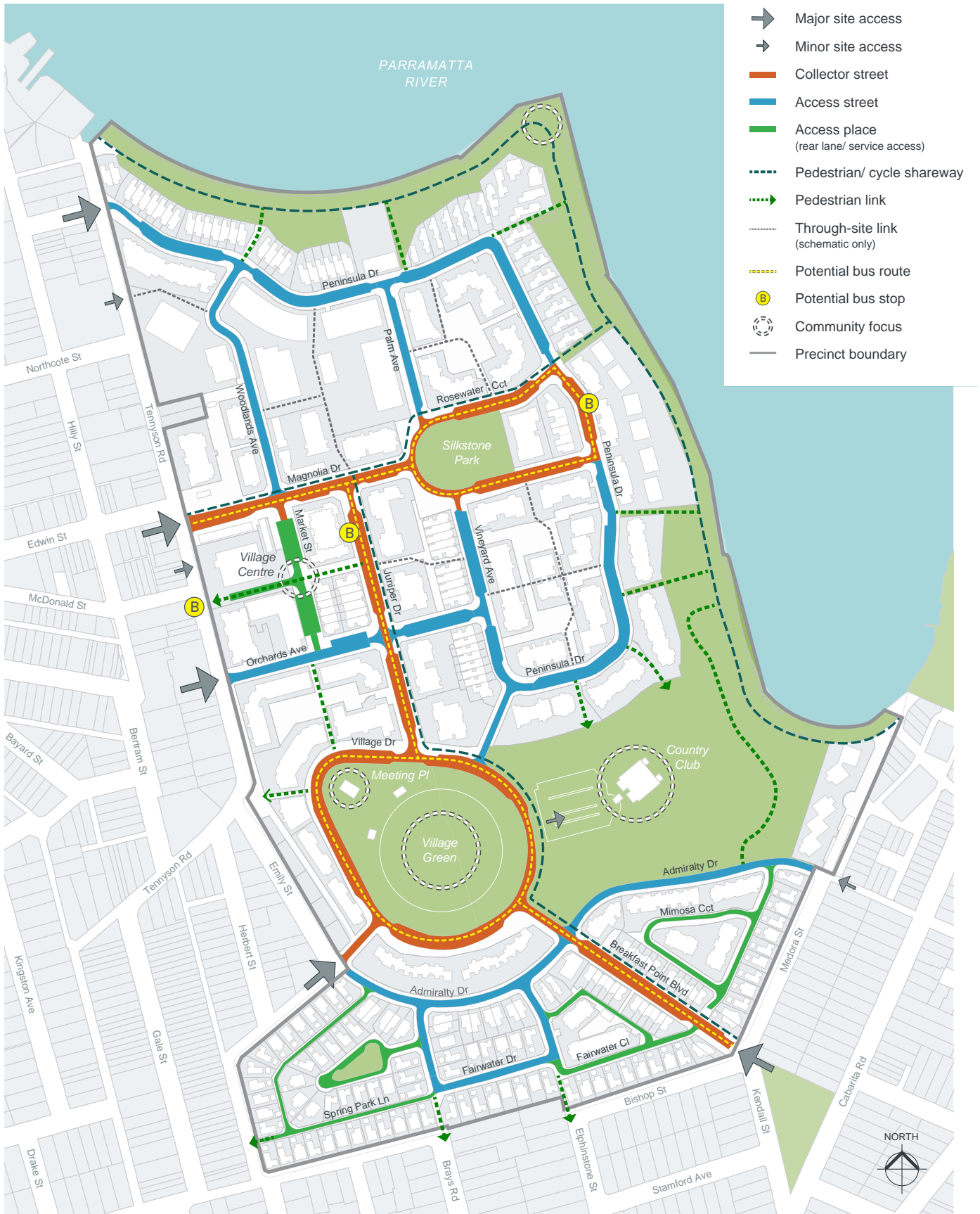

Figure K4-4 Access & Circulation Principles

## K4.5 Land use principles

Uses in Breakfast Point are residential and a range of potential adaptive uses for heritage items possible under the Remediation Certification. Permitted land use at Breakfast Point is in accordance with LEP 2013, which zones the land R2 Low Density Residential, R3 Medium Density Residential, B1 Neighbourhood Centre, RE1 Public Recreation and RE2 Private Recreation.

All of the land within the Breakfast Point precinct is zoned either R2 Low Density Residential or R3 Medium Density Residential with the exception of the area occupied by the Meter Readers' Office which lies within the B1 zone. Figure K4-5 and details below describe the land use principles:

### Residential

Breakfast Point is planned as primarily a residential neighbourhood. The LEP permits and other compatible uses to the extent that they contribute residential amenity, convenient services and employment.

### Residential (Transitional)

The initial development planned at Breakfast Point was single family dwelling sub-division to the south and south west of the site to provide an early environmental buffer between long-term development and neighbouring residential areas.

### Open Space (Public)

A 15m wide open space extending the full length of the water frontage of the site is to be dedicated for public foreshore access. This area is immediately behind the sea wall which is owned and maintained under the Community Scheme.

### Open Space (Community)

Open Space planned and provided under the Community Scheme includes the Village Green, Silkstone Park and all landscaped areas within the Community Scheme.

Community buildings, eg the Meeting Hall, the Recreation Club and active recreation facilities are planned and built within this open space. This area also includes some restricted private open space 'rights' under easements.

### Recreation & Social Uses

The Meeting Hall, Recreation Club and related recreation facilities are located on Open Space within Lot 1 of the Community Scheme.

### Village Centre

Adjacent to the remnant Mortlake Village precinct, a neighbourhood community convenience shopping and service centre has been built, comprising a convenience store, café, several small shops, a child care centre and market square, together with Community Scheme management and security offices. Work/ live terraces and shop-top apartments have been also built in this village precinct to enhance 24 hour activity and security.

### Heritage/ Adaptive Re-use

The uses for LEP 2013 scheduled heritage items are to be appropriate to the heritage conservation guidelines for the individual items, and comply with the relevant remediation certification. The economically sustainable preservation of the item will be a primary issue in the consideration of applications.

### Commercial/ Heritage Curtilage

The curtilage of heritage items certified for 'non-residential' uses. Uses compatible with heritage constraints and/ or remediation certification.



Figure K4-5 Land Use Principles

## K4.6 Landscape & open space

At least 12 hectares of open space has been provided at Breakfast Point. This includes the Village Green and oval, the Foreshore Park, Silkstone Park, the pocket park at Spring Park Circuit and the sidewalks. This open space, being part of Lot 1 in the Community Scheme, is community owned.

### Objectives

- O22 To ensure that landscape and open space will be a major defining characteristic of Breakfast Point.
- O23 To increase filtration and reduce stormwater run-off.

### Public Access to Open Space

| Controls |   |
|----------|---|
| C34.     | The public access network is to be legible, direct, safe, attractive and convenient.  |
| C35.     | Access to open space is to be well defined and provides a safe and active high quality public domain. Accessible open space for the recreation needs of residents is to be provided.  |
| C36.     | Foreshore access is to be clearly identifiable for public use.  |
| C37.     | Located no further than 3 minutes walk from any part, the continuous Village Green/Foreshore public open space complex, together with the Central Park will provide for the active and passive open space needs of all Breakfast Point residents, and to the wider community. |
| C38.     | Playgrounds and similar specific small facilities, together with a community recreation club and multi-purpose community meeting hall are to be integrated into this landscaped complex.  |
| C39.     | A 15m wide foreshore strip extending the full length of the harbour frontage behind the seawall is dedicated public land.   |

|      |  |
|------|--|
| C40. | Public Open Space (open access under the Community Land Management Act) provision is to include: <p><i>Village Green</i></p> <ul style="list-style-type: none"> <li>A formal fenced playing field, constructed over an area which includes the entombed stratum, extending to include a multi-purpose community meeting hall.</li> </ul> <p><i>Foreshore Area</i></p> <ul style="list-style-type: none"> <li>Incorporating a continuous 15 metre wide minimum width along the whole of the foreshore in Council's ownership, and additional community open space averaging a total of 30 metres width.</li> </ul> <p><i>Waterfront Park</i></p> <ul style="list-style-type: none"> <li>An informal east sloping area linking the Village Green to the Foreshore area, incorporating a community recreation club and associated facilities, constructed over a designated restricted area.</li> </ul> <p><i>Silkstone Park</i></p> <ul style="list-style-type: none"> <li>A formal, elevated, passive recreation park, providing a sense of arrival from the Tennyson Road approach and providing vistas to the harbour and beyond.</li> </ul> <p><i>Spring Park</i></p> <ul style="list-style-type: none"> <li>A pocket park has been provided in Spring Park Close.</li> </ul> <p><i>Market Square</i></p> <ul style="list-style-type: none"> <li>A open space is to be incorporated in the design of the Village Centre precinct. Its function is to provide for community activities, markets, performances, and any promotional activities which enhance the community spirit and vitality of the centre.</li> </ul> |
|------|--|

### Community & Private Open Space

| Controls |  |
|----------|--|
| C41.     | Community and private open spaces are to be provided and integrated into the design of each development precinct or project to adequately meet the needs of its residents. |

|             |   |             |   |            |  |             |   |            |  |
|-------------|---|-------------|---|------------|--|-------------|---|------------|--|
| C42.        | Issues to be considered in design include: <ul style="list-style-type: none"> <li>• Streetscape enhancement</li> <li>• Privacy landscaping and screening</li> <li>• Climate and sun control</li> <li>• Swimming pools etc</li> <li>• BBQ areas</li> <li>• Private outdoor living and dining</li> <li>• Service areas</li> <li>• Shade</li> <li>• View &amp; outlook enhancement</li> <li>• Boundary delineation</li> <li>• Solar Access</li> <li>• Environmentally Sustainable Design Standards</li> </ul>  |             |   |            |  |             |   |            |  |
| C43.        | The quantity and quality of communal and private open space and landscape treatment will be on a merits based assessment of each Development Application.   |             |   |            |  |             |   |            |  |
| C44.        | Indicative private open space provisions are as follows: <p><i>Upper level dwellings: balcony, terrace</i></p> <table border="1"> <tr> <td>1-2 bedroom</td> <td>min area 8m<sup>2</sup><br/>min dimension of 2m</td> </tr> <tr> <td>3+ bedroom</td> <td>min area 12m<sup>2</sup><br/>min dimension of 2m</td> </tr> </table> <p><i>Ground level dwellings: patio, terrace</i></p> <table border="1"> <tr> <td>1-2 bedroom</td> <td>min area 16m<sup>2</sup><br/>min dimension 4m</td> </tr> <tr> <td>3+ bedroom</td> <td>min area 35m<sup>2</sup><br/>min dimension of 4m</td> </tr> </table> | 1-2 bedroom | min area 8m <sup>2</sup><br>min dimension of 2m | 3+ bedroom | min area 12m <sup>2</sup><br>min dimension of 2m | 1-2 bedroom | min area 16m <sup>2</sup><br>min dimension 4m | 3+ bedroom | min area 35m <sup>2</sup><br>min dimension of 4m |
| 1-2 bedroom | min area 8m <sup>2</sup><br>min dimension of 2m   |             |   |            |  |             |   |            |  |
| 3+ bedroom  | min area 12m <sup>2</sup><br>min dimension of 2m  |             |   |            |  |             |   |            |  |
| 1-2 bedroom | min area 16m <sup>2</sup><br>min dimension 4m   |             |   |            |  |             |   |            |  |
| 3+ bedroom  | min area 35m <sup>2</sup><br>min dimension of 4m  |             |   |            |  |             |   |            |  |

## Community Facilities

| Controls |  |
|----------|--|
| C45.     | Community facilities included in the urban village, while owned and managed under the Community Plan, are publicly accessible. |
| C46.     | The Village Green is maintained as a full sized sports oval, with associated amenities and picnic facilities.                  |

|      |   |
|------|---|
| C47. | The Village Centre is to maintain its local convenience retail and community function, i.e. by ensuring that adequate space is provided for the following: <ul style="list-style-type: none"> <li>• a local convenience supermarket</li> <li>• flexible shop space for approximately 10 specialty shops grouped around the open market square</li> <li>• flexible live/ work terrace dwellings</li> </ul>   |
| C48. | The following other community facilities are to be provided/ maintained: <ul style="list-style-type: none"> <li>• a child care centre</li> <li>• a multi-purpose meeting hall to the north-west of the Village Green with strong connections to the Village Centre precinct</li> <li>• recreational facilities including a gymnasium, aerobics room, swimming pools, tennis courts, putting green, dining, library and function rooms.</li> </ul> |

## Planting Principles

| Controls |   |
|----------|---|
| C49.     | An informal indigenous planting palette should be adopted for informal, passive open space areas, foreshore reserve and to the major recreation centre open space.  |
| C50.     | A formal planting palette should be adopted for streets, squares and areas of strong urban character. Deciduous species should be used extensively for solar access and shade control and to provide seasonal variety and colour. |
| C51.     | Paving, fences, garden walls and all other built or service elements in the landscape are to be designed for minimum impact, to blend with soft landscape and be visually inconspicuous.  |
| C52.     | Vertical walls and horizontal paving are to be separated by a planting strip of ground cover or shrubs.   |



01.Mimosa Apartments, 02.Kendall Bay Waterfront, 03.Hunters Wharf Walkway, 04.Breakfast Point Boulevard, 05.Community Hall, 06.Silkstone Park, 07.The Village Green, 08.Pavillion at Silkstone Park



Figure K4-6 Landscape & Open Space Principles



## K4.7 Ownership & subdivision pattern

### Land Ownership

The ownership structure is in principle:

- Public (Council) Ownership - A 15m wide portion of Foreshore Public Open Space extending over the whole of the length of the water frontage , behind the sea wall. The maintenance and upkeep is the responsibility of the community association under Community Scheme DP 270347.
- Freehold Torrens Title - All single family dwelling lots having frontage to existing public streets (Medora, Bishop, Adams Street and Brays Road) are individually owned Torrens Title fee simple lots.
- Lower Stratum (Entombed Cell) - The AGL retains ownership and responsibility for the containment cell stratum located a minimum of 1m below the finished surface in the vicinity of the Village Green.
- Community Schemes - The remainder of the site will be within Community Schemes.

### Master Community Scheme

Comprises land indicated in Figure K4-7 including all 'open access' ways (streets and public pedestrian paths) on the land. This community scheme will be responsible for the management and maintenance of all roads, facilities, landscape and service infrastructure on the site, including Council's waterfront land.

### Other Community Schemes

A separate community scheme includes internal Torrens Title single dwellings and duplex dwellings. A separate community scheme also exists for the strata titled apartments.

### Public Access and Permeability

Under the Community Scheme all streets, and the vast majority of community open space areas are 'open access ways'. Easements provide for public access rights, obligations and law enforcement as if in public ownership. Some community open space areas are subject to restrictive easements for services or private use. Refer to registered community plan DP 270347.

The objective is to free the Council of liability for the ongoing service and maintenance costs on the site whilst ensuring access and permeability to all normally 'public' facilities.

### Subdivision Pattern

The subdivision pattern is designed and staged to reflect the rehabilitation and sequential ownership transfer program for the site. Each stage is to be certified prior to transfer of ownership and its availability for development. Seven 'super lots' have been created to facilitate this. The subdivision yields:

- A land-subdivision creating individual single family lots fronting existing streets (Brays Road, Bishop, Adams and Medora Streets)
- Community subdivisions for land north of the perimeter, single family lots and another community subdivision for the remainder of the land
- A separate lot will be created over the 15m wide waterfront, vested in Council
- A stratum subdivision encompassing the containment cell underground to remain with AGL



01. Pedestrian link to Community Hall, 02. Silkstone Park, 03. Community event

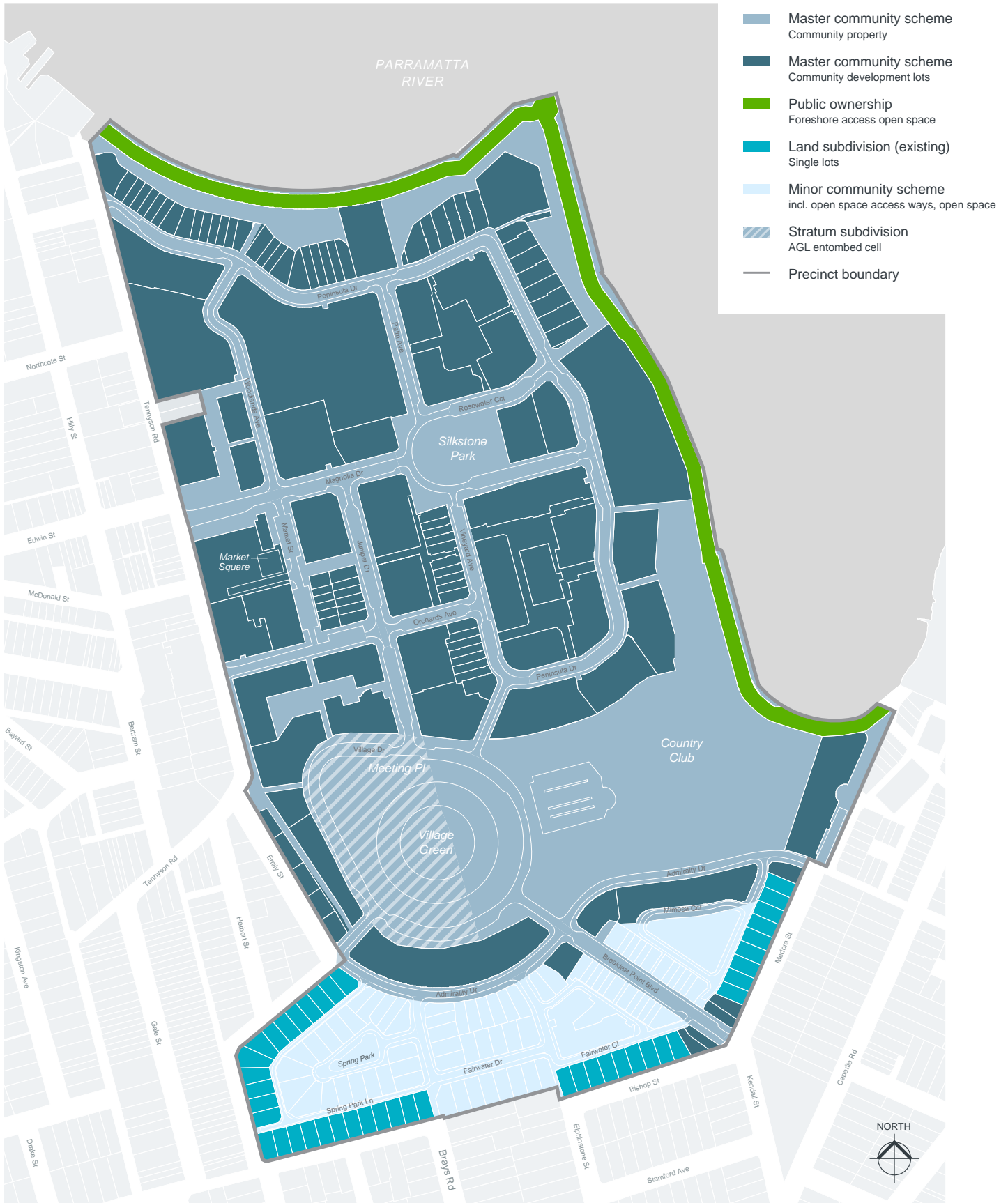

Figure K4-7 Ownership Principles

## Precincts

The majority of Community development lots (Master community scheme) have been arranged into Precincts as indicated by Figure K4-8 Precincts

## K4.8 Floor space ratio

### Objectives

- O24 To ensure that buildings are compatible with the bulk and scale of the desired future character of the locality,
- O25 To provide a suitable balance between landscaping and built form
- O26 To minimise the effects of bulk and scale of buildings.

### Controls

|      |  |
|------|--|
| C53. | The maximum floor space ratio for the land identified in Figure K4-3 must not exceed 0.67:1.   |
| C54. | Development applications are to be accompanied by a cumulative compliance schedule demonstrating that the total floor space ratio of all development within the Breakfast Point precinct does not exceed 0.67:1. |



Figure K4-8 Precincts

## K4.9 Building envelopes & built form

### Objectives

The building envelope and built form objectives are to provide reference points for Council's merits-based assessment of Development Applications at Breakfast Point. They are:

- O27 To acknowledge and enhance the prominent visual relationship Breakfast Point has to Parramatta River and its environs.
- O28 To provide a complementary interface with the surrounding urban fabric, and transition between existing and new, higher density, living areas.
- O29 To provide a vision for the future built character of Breakfast Point.
- O30 To establish principles of building arrangements and envelopes and their relationships to site features, adjacent development, and the public domain.
- O31 To provide a high standard of amenity and quality of living environment for residents.

### Parramatta River Visual Catchment

The visual character of Breakfast Point viewed from the River, its foreshores and viewpoints beyond is to comprise:

#### Foreshore Open Space Edge

| Controls |  |
|----------|--|
| C55.     | A foreground dominated by informal vegetation and tree planting above the sea wall.  |
| C56.     | Building foreshore setbacks generally are to be varied and no less than 30m.   |
| C57.     | To provide visual connection to inner areas, individual building facades fronting the foreshore should be articulated and no more than 60m long. |
| C58.     | Compatible public or community structures and facilities may occur in the foreshore open space.  |

## Pier Precinct (Active Waterfront Area)

### Controls

- |      |  |
|------|--|
| C59. | A formally landscaped area, focusing on the pier and associated water-based uses. Buildings in this precinct may include commercial uses at low level, and to provide interest, variety and counter-balance the scale of the pier. |
|------|--|

### Skyline

#### Controls

- |      |  |
|------|--|
| C60. | The skyline is to comprise of articulated low-to-mid rise roof forms interspersed with vegetation.   |
| C61. | Roof forms are to be simply designed, modulated to a scale, and in materials and colours recognising the significant views to the site.  |
| C62. | Roof plant and fixtures are to be fully integrated into the roof design.   |
| C63. | Taller buildings are to be located towards the centre of the site, on higher land, with building height reducing towards the waterfront and adjacent development boundaries, two to five storey buildings predominate. |

### Interface with Existing Residential Areas

#### Controls

- |      |   |
|------|---|
| C64. | Development fronting the adjacent residential streets (Medora, Bishop, Adams Street and Brays Road) is to comprise dwellings or attached dwellings. |
|------|---|

### Streetscape & Public Domain Character

The vision for Breakfast Point is:

- A built environment which optimises available light and sun to private and public domains within an orchestrated landscaped setting.
- A vigorous and interesting public domain reinforced by landscape and its defining, proportioned, and articulated architectural edges.



Figure K4-9 Building Envelope Principles & Heights

## Building Height

| Controls |  |
|----------|--|
| C65.     | Building heights are to be designed to minimise the amenity impact of new development on adjoining areas and to ensure that buildings are appropriately scaled in relation to street widths and open spaces. |
| C66.     | The maximum permissible height for any building at Breakfast Point is 9 storeys.   |
| C67.     | Refer to Figure K4-9 Building Envelope Principles & Heights which shows building heights in storeys.   |

Figure K4-13 on page K-35 demonstrates how the roof level of a building with a flat roof is lower than the ridge level of a similar building with a pitched roof. This results in improved view access.

## Solar Access, Light & Privacy

Residential development at Breakfast Point is to be in accordance with State Environmental Policy No65 – Design Quality Residential Flats standards. Where SEPP 65 does not strictly apply, (e.g. single, attached and two storey apartments) the relevant amenity principles are adopted as the guideline for minimal acceptable residential amenity standards.

| Controls |   |
|----------|---|
| C68.     | The location, planning and orientation of buildings and open space is to maximise opportunities for solar access, natural light and privacy to dwellings.   |
| C69.     | Buildings are to be sited and designed to maximise available sunlight to north-facing windows of living areas and principal areas of open space, having regard to slope, views and overshadowing.   |
| C70.     | Solar access to each dwelling is to be maximised. Sunshine is to be available to a main living area and private open space of each dwelling for a minimum of three hours duration between the hours of 9am and 5pm at 21 June (mid winter). |

|      |   |
|------|---|
| C71. | Privacy design performance criteria should be in accord with the NSW Model Code: A Model for Performance-Based Multi-Unit Housing Codes: NSW Dept Urban Affairs and Planning 1997 |
|------|---|

## Mass & Proportion

### Objectives

- O32 To provide for streetscape relief, pedestrian, landscape, breeze and view corridors.
- O33 To maintain an appropriate residential scale to the Breakfast Point streetscape.

### Controls

|      |  |
|------|--|
| C72. | Building facade lengths should not exceed 60 metres without a pronounced break or relieving treatment. |
|------|--|

## Roof Form & Colour

### Objectives

- O34 To minimise the visual prominence of roofs being overlooked by residents of higher dwellings.
- O35 To provide an articulated skyline to Breakfast Point from distant viewpoints.
- O36 To provide visual relief to the streetscape.
- O37 To encourage subtle contrast and variety within a consistent design theme.
- O38 To encourage the use of dormer style windows.

### Controls

|      |  |
|------|--|
| C73. | Hipped and gable type roofs with wide eaves are to be the predominant roof form.                             |
| C74. | All roof top services, vents, lights, are to be integrated into the roof design.                             |
| C75. | Roof materials may vary. Roof colours are to be inconspicuous grey tones.                                    |
| C76. | Flat roofs with carefully selected finishes and considered detailing may be used to facilitate view sharing. |

## Facade Treatment

### Objective

O39 To enrich the streetscape in detail.

| Controls |   |
|----------|---|
| C77.     | Facades, particularly those defining streets are to provide modulation of light and shade through finessed secondary architectural detail, contrasting with heavier wall and roof elements. |
| C78.     | Contributing elements could include eaves, sun control, hoods, louvres, shutters, pergolas, verandahs, balconies, balustrades, porticoes, loggias, dormers, roof lanterns and ventilators.  |

## Setbacks & Addressing the Street

### Objective

O40 To reinforce the streetscape character.

| Controls |   |
|----------|---|
| C79.     | Subject to adequately meeting amenity performance requirements, all buildings are to define (be parallel to) the streets and have their primary pedestrian access and address from their primary street frontage. |
| C80.     | Setbacks from the street are to reflect the precedent/s established for the street.   |

## Colour & Light

### Objective

O41 To enhance the amount of light and reflected light available to public and private domains in a comparatively dense built environment.

| Controls |   |
|----------|---|
| C81.     | The predominant primary walls are to be light soft colours.               |
| C82.     | The predominant colour for secondary architectural detail is to be white. |

## Ancillary Built Elements

| Controls |  |
|----------|--|
| C83.     | All built elements (fences, garden and retaining walls etc.) not part of a building are to be designed to blend into the landscape to minimise their visual intrusiveness. |

## Building Types

The following residential building types are anticipated at Breakfast Point responding to different locations, market sectors and lifestyles.

- Single houses - located opposite existing single dwellings and also within Community Scheme No.1, opportunity for rear access
- Semi-detached houses - rear and street car access
- Terraces - 2-3 storey, rear and semi-basement carparking
- Apartment building 2-3 storeys - semi basement carparking
- Apartment building 5 storeys - lift access, semi-basement and basement carparking
- Apartment building 9 storeys - expression of top, middle and base, basement carparking
- Waterfront houses - large single dwellings, terraces and duplexes with courtyard gardens, attached double garages

Retail, commercial and community buildings are anticipated as 1 and 2 storey, with residential development over (upper levels) where appropriate.

## Adaptable Housing

| Controls |  |
|----------|--|
| C84.     | A minimum of 5% of the total dwellings are to be designed as readily adaptable to the requirements of the Essential Features of AS4299-1995 'Adaptable Housing'. |
| C85.     | Adaptable housing is to be located within 300m of the Village Centre.  |





01.Five storey apartment building, 02.Vertical articulation of facade, 03.Two storey corner built form, 04.Detached two storey family dwelling, 05.Articulated building entry, 06.Buildings addressing open space, 07.Semi detached housing typology, 08.Corner treatment, 09.Detached dwelling, 10.Heritage-listed Meter Reader's Office, 11.High density apartments



Figure K4-10 Urban Design Principles

## K4.10 Heritage conservation

The buildings and structures scheduled as heritage items in Canada Bay Local Environmental Plan are to be conserved and adaptively reused.

No heritage item is to be demolished, altered, removed or modified without Council consent. Listed heritage items are:

### Gate House and Gates

Brick building with slate roof, flanked by weighbridges.

Possible uses: Security, Commercial

### Office No.1

Early 20th Century brick office building with tile roof, bullnosed iron awnings, arches over windows.

Possible uses: Information and estate management, Commercial

### Brick Wall to Tennyson Road

Brick wall with engaged piers and spandrels. Additional openings will be made in the wall to provide vehicular access for cars and service trucks and to increase visual and pedestrian connections to adjacent urban precinct.

A Conservation Management Plan has been prepared in relation to this structure.

### Meter Readers Office

Brick and slate building with pilasters and large overhanging eaves, which are supported by wooden brackets. Formerly contained a roofed walk-through bay to hold the time-keeping appointments.

Possible uses: estate management, commercial.

### Blacksmiths Workshop

Polychromatic brick building with classical influences such as pilasters, string course and pediment. Roof trusses are lightweight and cast iron semi-circular headed windows have 12 panes of circular openings with louvres.

Possible uses: community recreation and amenities, commercial

### Plumbers Workshop

Two storey brick building with parapet string course, semi-circular arches, surmount doors and multi-paned windows.

Possible uses: An interpretive display illustrating the historical roles of Breakfast Point, its locality and people is to be provided on site. The facility should include indoor and outdoor exhibits.



01.The Gatehouse, 02.Tennyson Rd Wall, 03.Blacksmiths Workshop



Figure K4-11 Heritage Conservation Principles

## K4.11 Remediation

The land has been remediated under an audited Remediation Action Plan (RAP).

### Land Use and Development Constraints

The four certified remediation zones are as follows:

#### 1. Unrestricted Residential Zone

There are no restrictions on land use in this zone. Development anticipated in the certification of this zone includes all forms of residential buildings, child care and school facilities, commercial and industrial buildings, recreational facilities and open space.

#### 2. Restricted Residential Zone

There are no restrictions on this type of land use in this zone, however, development is constrained by a Section 88b Instrument attached to the land title. This instrument effectively prohibits construction or disturbance below RL AHD 13.00.

Development anticipated in the certification of this zone includes all forms of residential buildings, child care and school facilities, commercial and industrial buildings, recreational facilities and open space.

Council will not grant Development Consent in this zone involving construction or disturbance below RL AHD 13.00, unless the Application includes a 'Work Method Statement' certified by the site auditor.

#### 3. Non Residential Zone

This land includes areas which may contain low level residual contamination, It includes the area above the 'containment cell stratum'.

The anticipated uses in this zone include open space, playing fields, commercial or industrial, roads and infrastructure. Limited residential development could be permitted in this zone subject to certification by the site auditor.

#### 4. Commercial/ Industrial Zone

This land includes areas under existing buildings proposed to be retained. The nature and extent of development and construction in this zone is constrained by a Section 88b Instrument attached to the land title.

Anticipated uses include commercial or industrial. Council will not grant Development Consent in this zone unless the Application includes a 'Work Method Statement' certified by the site auditor.



Figure K4-12 Remediation Zones

### K4.12 Environmentally sustainable design

#### Objectives

- O42 To reduce dependence on non-renewable and environmentally detrimental energy resources.
- O43 To reduce household energy demands.
- O44 To provide convenient and pleasurable access alternatives to the use of motor vehicles for local trips.
- O45 To reduce residential waste to landfill.
- O46 To minimise pollutants to atmosphere, ground and water.

#### Controls

| Controls |  |
|----------|--|
| C86.     | 90% of the individual population is within 5 minutes walking distance from the Village Centre.   |
| C87.     | All major destinations, the Village Green, the Recreation Centre, the Village Centre and Intensive Water Activities are located on a bus route.                                    |
| C88.     | A ferry/ bus interchange links the community to the regional employment centres of Sydney and Parramatta. Ferry usage is encouraged by provision of commuter parking at the wharf. |
| C89.     | A comprehensive pedestrian/ cycleway network provides safe, convenient and attractive links between facilities.  |
| C90.     | Priority is given to deciduous trees and shrubs to the north of internal and external living spaces to maximise solar and light availability in winter.                            |
| C91.     | The extensive foreshore landscape area is predominantly planted using indigenous species, remnant mangroves in Kendall Bay are retained.   |
| C92.     | Hardstand areas, roads and other impervious surfaces are minimised.  |

### K4.13 Definitions

"Storey" means a floor which has more than 50% of its volume above finished ground level.

"Finished ground level" means finished ground level which is determined at any point by straight-line interpolation between the designed (or built) levels at street frontage, adjacent allotment or open space boundaries.

"Existing ground level" means existing ground level which is determined at any point by straight-line interpolation between the existing levels at street frontage, adjacent allotment or open space boundaries.

A basement bounding wall is not to exceed 1.5m above the finished landscaped level unless adequately screened to Council approval.

An attic area wholly within a roof space, except for dormer style windows, is not a storey.

A mezzanine, as defined under the Building Code of Australia (BCA), may not be considered a storey subject to Council's merits assessment.

"Community" referring to land or property means land within Lot 1 of the Community Scheme DP 270347.

"Community plan" means the registered deposited plan under Community Scheme DP 270347.

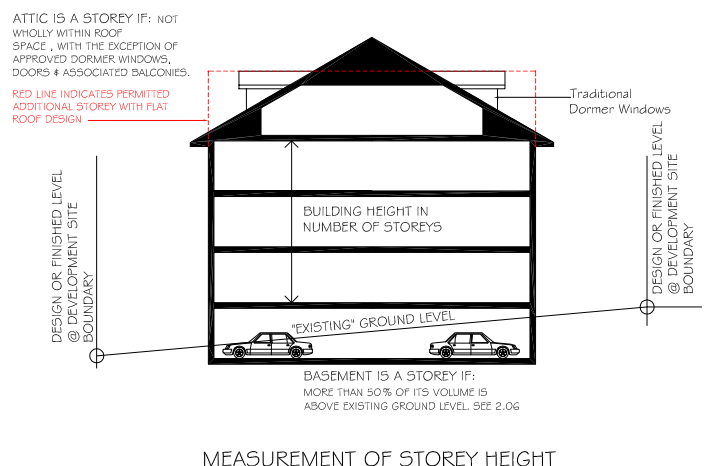

Figure K4-13 Measurement of storey height

### K4.14 Provisions for single dwellings

The following additional provisions for single dwellings apply to the area identified in Figure K4-14 Additional provisions for single dwellings location map.

#### Objectives

- O47 To preserve and enhance the established character of existing streets to the perimeter of the Breakfast Point site.
- O48 To ensure the bulk, scale, pattern and character of the new dwellings are consistent with existing development.
- O49 To avoid abrupt changes in visual character between the existing development and the Breakfast Point development.
- O50 To provide high standards of residential amenity to the new development.
- O51 To encourage best practice in Environmentally Sustainable Development.



Figure K4-14 Additional provisions for single dwellings location map



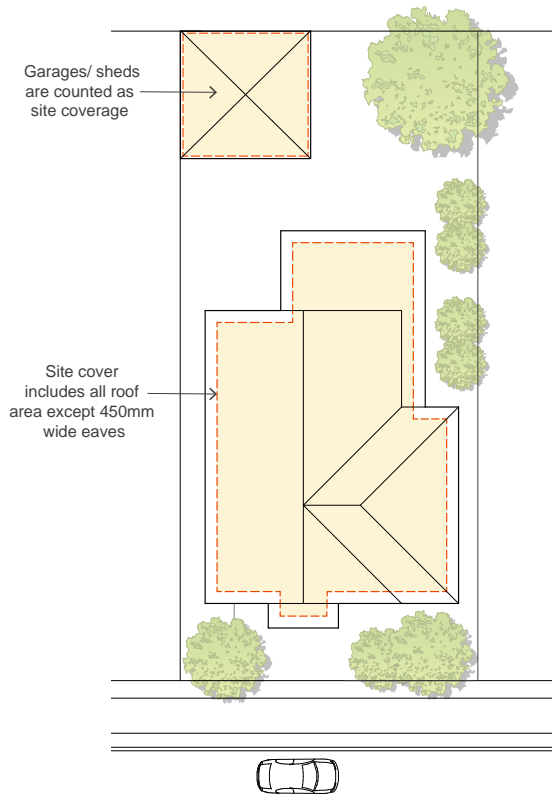

Figure K4-15 Building site cover

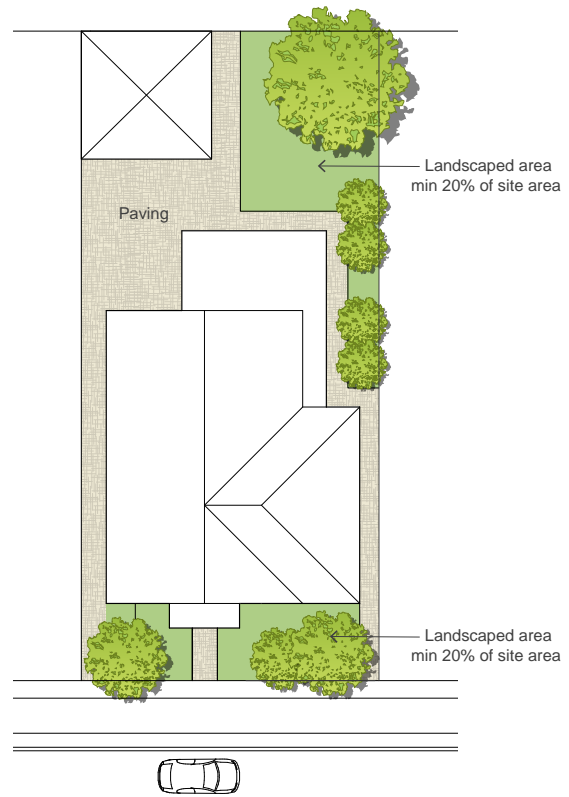

Figure K4-16 Landscaped area

**Subdivision**

O52 To maintain the streetscape character and the planned residential density.

**Controls**

C93. One single dwelling only is permitted per lot. Subdivision is prohibited.

**Building Site Cover**

O53 To maintain sufficient land available for private open space, light and sun penetration, landscape, storm-water absorption and flow in accordance with sustainable development principles.

**Controls**

C94. No more than 50% of a lot area is covered by built development. Built development includes all roofed areas except eaves extending up to 450mm from external walls. Refer to Figure K4-15.

**Landscaped Area**

O54 To ensure the residential precinct has an atmosphere of a ‘garden suburb’.

O55 To provide adequate site absorption of storm water and to provide for reasonable photosynthesis in line with sustainable environmental principles.

**Controls**

C95. A minimum of 20% of the site area is to be soft landscape, grass, ground-cover, shrubs, and trees. Refer to Figure K4-16.

**Dwelling Setbacks**

**Primary Frontage**

- O56 To complement the character of existing neighbouring streetscape.
- O57 To maintain generally consistent landscape area between kerb and dwellings on both sides of the street.
- O58 To encourage elements that break down the visual bulk and scale of buildings in the streetscape.

| Controls |  |
|----------|--|
| C96.     | Main House Walls: minimum 5m setback.  |
| C97.     | Single storey elements such as pergolas, verandas, terraces, porticos, bay windows and partially enclosed elements: minimum 3m setback. Refer to Figure K4-17.   |
| C98.     | Main house setbacks may be averaged to provide an area between the house and the front boundary equal to that area provided by a 5m setback. A minimum setback for any part of 3m must be maintained. Refer to Figure K4-18. |

**Adjoining Lots (Side Boundary)**

- O59 To provide separation between houses fronting streets.
- O60 To provide opportunity for landscape between dwellings.
- O61 To permit reasonable solar and light access between dwellings.

| Controls |  |
|----------|--|
| C99.     | Wall height up to 3.6m above natural ground level: 1.0m minimum. Wall height up to 7.2m above natural ground level: 1.5m minimum. Refer to Figure K4-19.                                 |
| C100.    | Garden or retaining walls: when over 500mm high, to be setback a distance equal to the height of the wall.   |
| C101.    | Single storey garages wall height up to 3m: nil, provided all maintenance and services can be satisfactorily achieved wholly within the allotment, and solar access criteria can be met. |

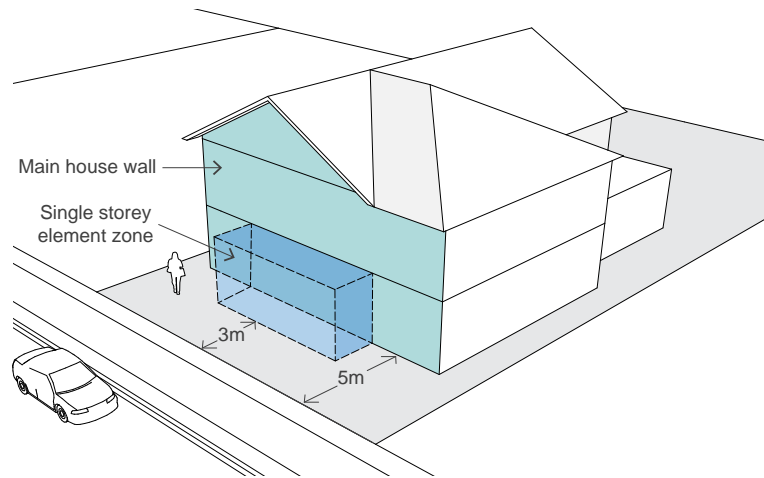

Figure K4-17 Minimum front setback requirements

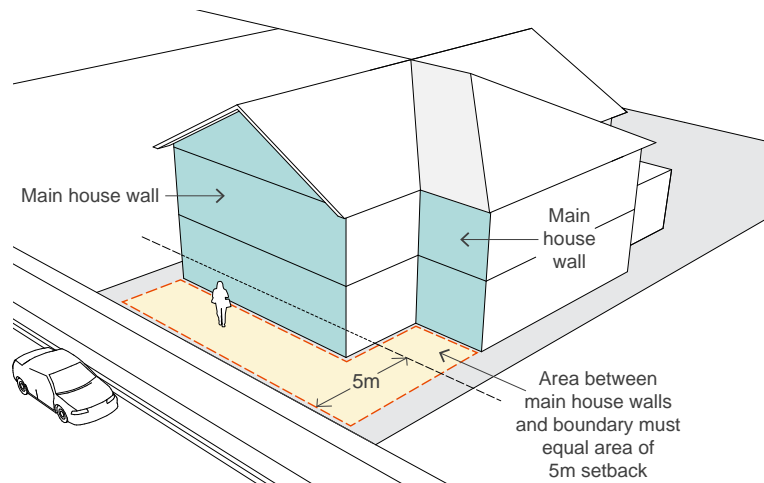

Figure K4-18 Minimum front setback requirements - alternative

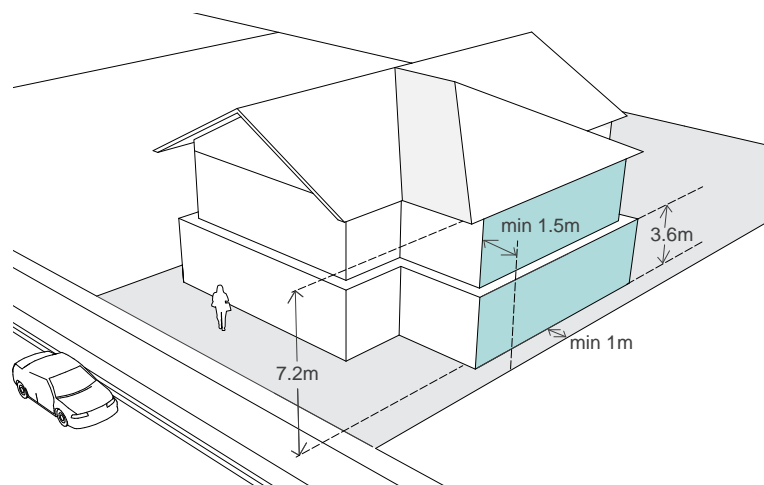

Figure K4-19 Minimum side setback requirements

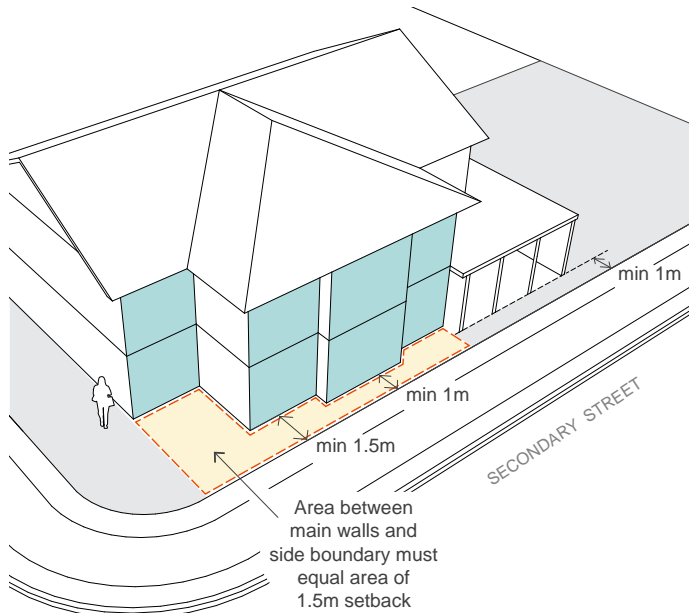

Figure K4-20 Secondary street frontage setback requirements

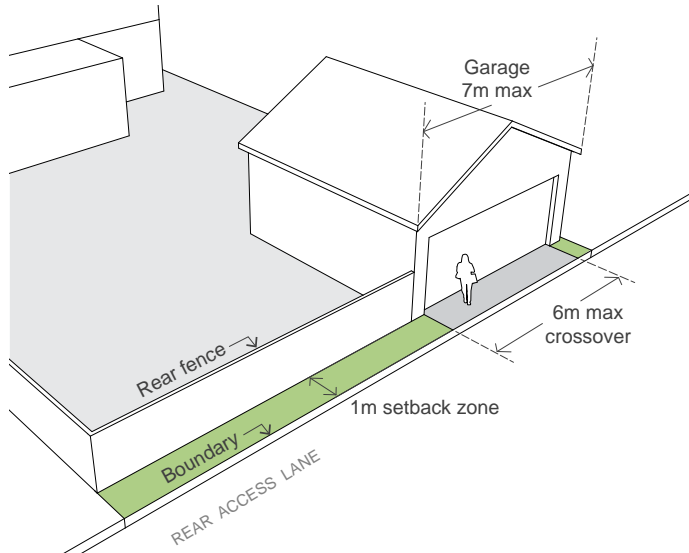

Figure K4-21 Required minimum setback from access lanes

**Secondary Street Frontage (Corner Lots)**

- O62 To maintain streetscape character whilst retaining reasonable privacy and security to private open spaces.
- O63 To encourage variation and relief in facade treatment facing public space.

**Controls**

|       |  |
|-------|--|
| C102. | Main House Walls: 1.5m minimum.  |
| C103. | Pergolas, Verandas, Terraces, porticos and other partially enclosed elements: 1.0m minimum.  |
| C104. | Main house setbacks may be averaged to provide an area between the house and the front boundary equal to that area provided by a 1.5m setback. A minimum setback for any part of 1.0m must be maintained. Refer to Figure K4-20. |

**Encroachments**

**Controls**

|       |  |
|-------|--|
| C105. | Eaves, gutters and downpipes may encroach into setbacks in accordance with BCA and to 450mm maximum. |
|-------|--|

**Setback from Access Lanes**

- O64 To provide a consistent access lane character softened by landscape.

**Controls**

|       |  |
|-------|--|
| C106. | All structures, garages and fences are to be setback 1.0m from any boundary adjoining a lane. Refer to Figure K4-21.<br><br>Note: This setback area is to be an easement in favour of the Community Association who will be responsible for its treatment and maintenance. |
|-------|--|

## Access

- O65 To maintain existing streets as the address of new dwellings.
- O66 To ensure the design of dwellings presents a frontage to existing streets consistent with the existing street character.

### Controls

|       |   |
|-------|---|
| C107. | Street numbers and mailboxes will be located on the streets to which the dwellings permitted by this DCP are required to have the primary frontage. |
| C108. | Public and visitor access will be from these streets.   |
| C109. | On-street visitor parking will be provided on these streets.  |
| C110. | On-street parking will not be available in lanes.   |
| C111. | Dwellings will address and be designed to 'front' these streets.  |

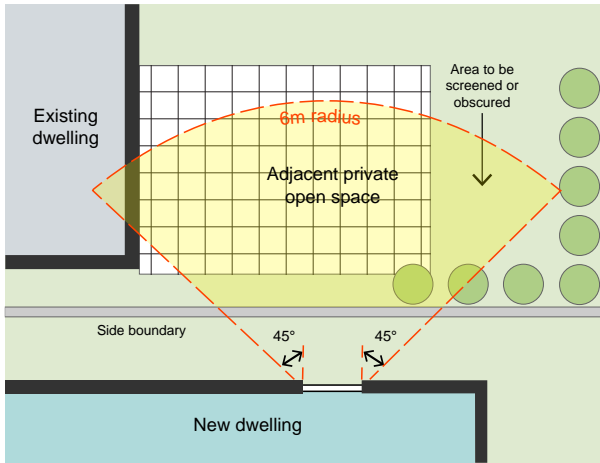

Figure K4-22 Screening of views to adjacent private open space from a side window

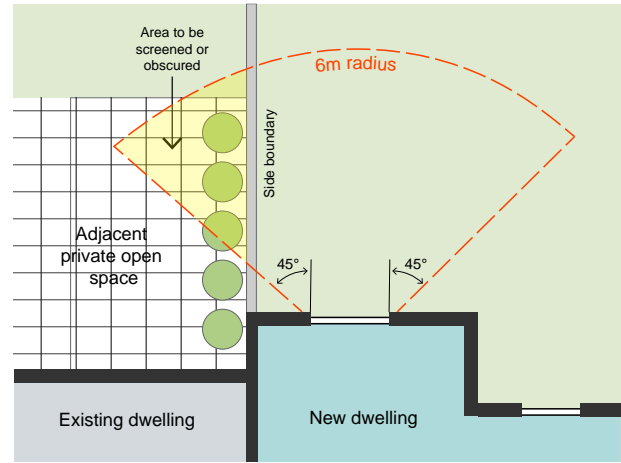

Figure K4-23 Screening of views to adjacent private open space from a back window

**Tree Preservation**

- O67 To preserve and maintain the master-planned prominence of landscape in the character of the residential street.
- O68 To assist in meeting environmentally sustainable development objectives.

| Controls |  |
|----------|--|
| C112.    | All trees are subject to Council's Tree Preservation Order.                                  |
| C113.    | Street trees must not be interfered with without the prior consent of Council.               |
| C114.    | Existing trees within the site and on public land must be protected throughout construction. |

**Landscaping**

- O69 To ensure landscape and planting is considered and integrated with house planning and design.
- O70 To ensure sustainable development principles are acknowledged and that impacts on neighbouring amenity are considered at the planning stage.

| Controls |   |
|----------|---|
| C115.    | A Landscape Principles Plan is to be submitted for approval with building plans and include detail of tree location, mature size, evergreen or deciduous, screening, hedges, shrubs, turf areas, fences, and paths and paved areas. |

**Privacy**

- O71 To ensure the siting, design and landscaping of buildings minimises direct overlooking into habitable rooms and private open space.
- O72 To ensure the siting, design and landscaping of buildings provides acoustic privacy to habitable rooms and open space.

| Controls |   |
|----------|---|
| C116.    | Habitable room windows are to be predominantly oriented to the street and rear of lots.   |
| C117.    | Habitable room windows are to be located outside a 45° angle of view from any habitable room window of any adjacent dwellings within 6m. Refer to Figure K4-22. |
| C118.    | Alternate screening, obscure glazing and other solutions will be considered on merits.  |
| C119.    | A minimum separation between habitable room windows and balconies of 12m is to be provided unless provided with approved screening.                             |
| C120.    | Landscaped plans are to include planting designed to minimise overlooking adjacent private open spaces.   |

### Swimming Pools and Surroundings

O73 To ensure the construction and use of swimming pools does not unduly impact on neighbourhood amenity.

| Controls |  |
|----------|--|
| C121.    | Prohibited: Pools between dwellings and the primary street frontage and above ground pools.                                    |
| C122.    | Safety requirements are to be to Australian Standards, and Statutory requirements.   |
| C123.    | Pools and surround paving are to be setback a minimum of 1.0m from any boundary. This setback is to be soft landscape treated. |

### Fencing

#### Primary Street Frontage Fencing (Front Fence)

- O74 To provide a consistent street-scape character.
- O75 To maintain a landscaped dominated street-scape visual environment.
- O76 To minimise 'built elements' in front of dwellings.

| Controls |  |
|----------|--|
| C124.    | Fences are to be no greater than 1m in height. Refer to Figure K4-24.  |
| C125.    | Front fence treatment is to extend along side boundaries to the line of the adjacent front wall of the dwelling or 5m from the front boundary whichever is greater. Refer to Figure K4-24. |
| C126.    | Fences are to be of semi-open design with low shrubs planted behind. Materials can include masonry, timber picket, metal spearpoint and combinations. Refer to Figure K4-26.               |

#### Rear Lane, Side Street and Public Area Fencing

- O77 To provide a consistent fencing character throughout the estate.
- O78 To permit reasonable privacy and security without streets and public access ways being dominated by paling fences.

| Controls |  |
|----------|--|
| C127.    | Maximum 1.8m in height, lapped and capped timber paling fence to estate detail, painted Dulux Timbercolour Birch Grey or equal. Refer to Figure K4-25. |
| C128.    | Paling fences to boundaries fronting side streets or public access ways are not to extend more than 2/3 the length of boundary.                        |
| C129.    | The paling face of fencing is to address streets and public areas.   |

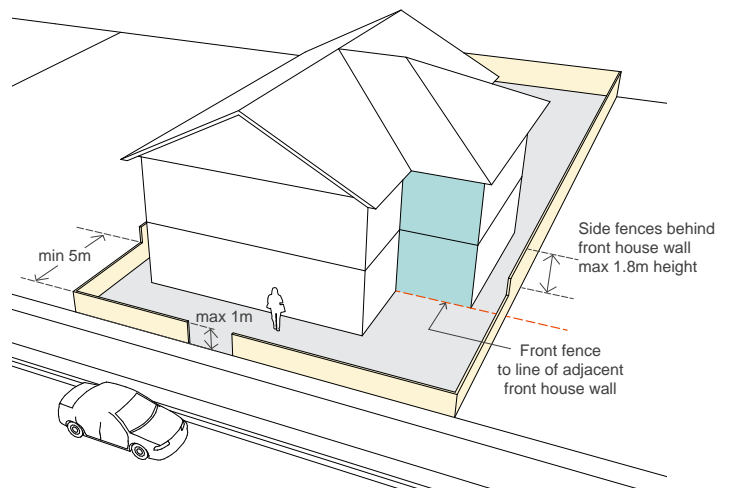

Figure K4-24 Front and side fence requirements

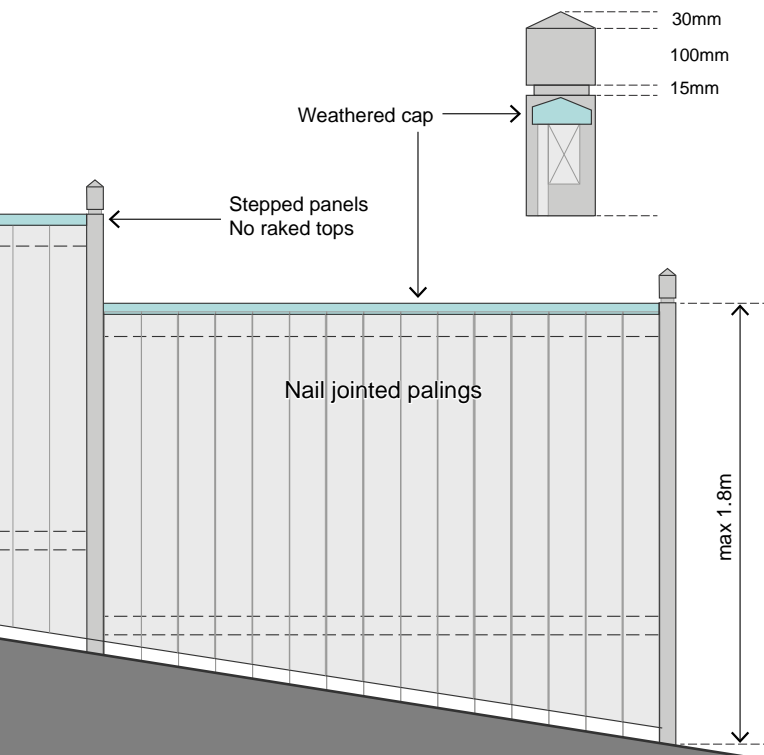

Figure K4-25 Fence detail (adjoining allotment)

**Adjoining Allotment Fencing (Side and Rear)**

- O79 To provide privacy and security to private outdoor spaces.
- O80 To allow for containment of domestic pets permitted under the management plan.

**Controls**

|       |  |
|-------|--|
| C130. | Maximum 1.8m high lapped and capped timber paling fence to estate detail, painted Dulux Timbercolour Birch Grey or equal. Refer to Figure K4-25. |
| C131. | No side fence is to be closer to the street than the main house wall facing the street. Refer to Figure K4-24.                                   |

**Adjoining Community Open Spaces**

- O81 To provide a natural landscaped edge to the community open space whilst providing for individual privacy and security.

**Controls**

|       |  |
|-------|--|
| C132. | Maximum 1.8m high black galvanised pipe and chain wire fences and gates backed by screening landscape. |
|-------|--|

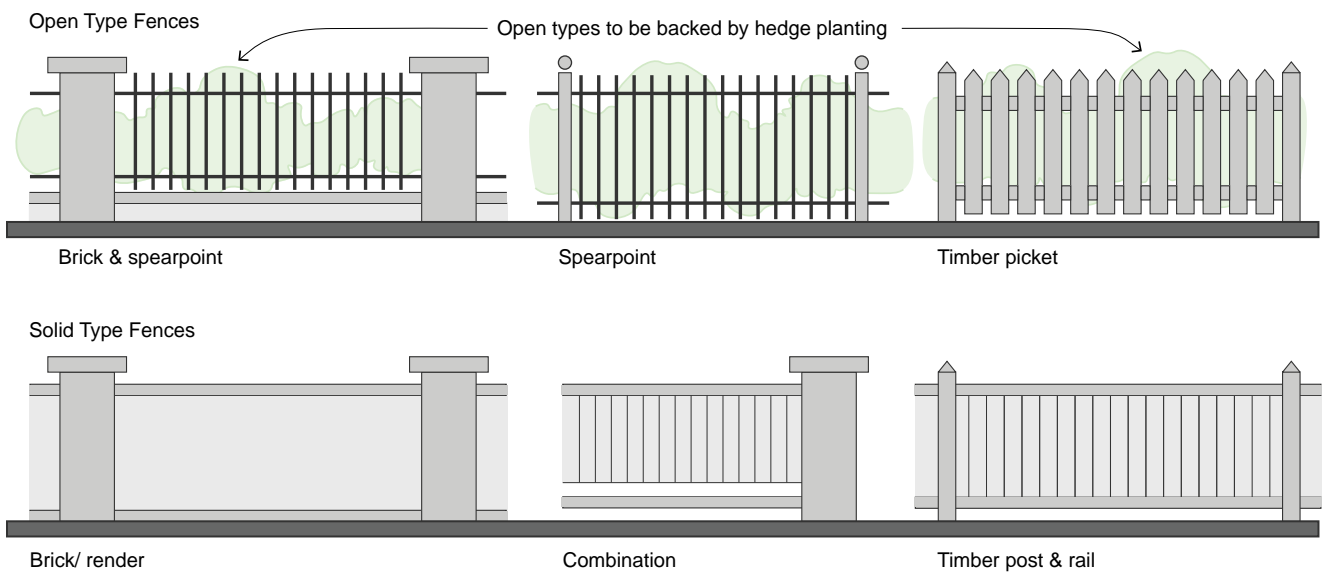

Figure K4-26 Fence types

**Mail Box and Street Number**

O82 To facilitate location of individual dwellings and to maintain consistency in visual elements contributing to street-scape character.

| Controls |  |
|----------|--|
| C133.    | Each dwelling is to have a mailbox, and a clearly visible street number unit to the primary street frontage integrated in fencing treatment to Australian Post requirements. |

**Building Form, Height & Character**

**Wall Height and Storeys**

- O83 To preserve views and outlooks.
- O84 To minimise shadow and privacy impacts.
- O85 To ensure buildings reflect the natural slope of the land.
- O86 To maintain a consistent two storey residential scale.
- O87 To provide residents reasonable expectations for adjacent development.

| Controls |   |
|----------|---|
| C134.    | The external wall height is to be no greater than 7.2m above the natural ground level at any point. Refer to Figure K4-27.  |
| C135.    | A higher gable treatment up to the maximum ridge height of 9.5m may be permitted, where it can be shown that there is no additional impact on neighbourhood amenity. Refer to Figure K4-27. |
| C136.    | No building shall exceed 2 storeys in height.   |
| C137.    | Attic accommodation wholly within the roof space may be permitted subject to satisfactory design of dormer or skylight windows in terms of streetscape and neighbours amenity.              |

**Roof Height and Shape**

O88 To maintain a consistent visual roof-scape character and form, compatible with existing Concord residential precincts, when viewed from the public domain and higher buildings and vantage points.

| Controls |   |
|----------|---|
| C138.    | A minimum roof pitch of 27.5° is required. Refer to Figure K4-27.   |
| C139.    | The maximum ridge height is to be 9.5m above the natural ground. Refer to Figure K4-27.   |
| C140.    | Flat, curved and other nontraditional roof forms will only be considered where Council can be satisfied they are appropriate under the circumstances. |

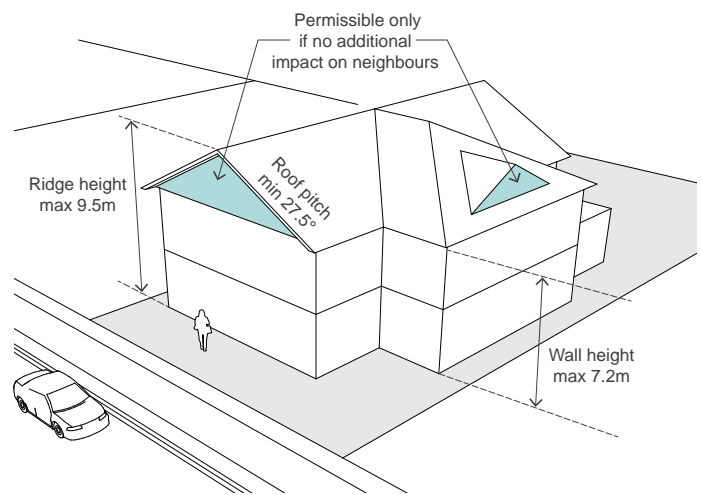

Figure K4-27 Maximum heights and minimum roof pitch



**Streetscape Character**

- O89 Design, detailing and finish is to:
  - be in scale with the existing development in the street.
  - add visual interest.
  - enable differentiation between dwellings viewed from the street.
  - provide entries readily apparent from the primary street.
  - convey a sense of address.
- O90 Garages and parking are to be sited and designed to minimise impact on the street.

| Controls |   |
|----------|---|
| C141.    | The front door and some main windows are to face the primary street frontage.   |
| C142.    | Street facades are to be articulated by elements such as bay windows, dormer windows, verandas, pergolas, balconies, gables, etc. |

Note: vehicle access prohibited from Brays Road, Bishop Street, Medora Street and Adams Lane.



Example of a well articulated facade with the main entry, windows, balconies and a verandah clearly addressing the street

**External Materials, Finishes and Colours**

- O91 Materials, Finishes and Colours are to:
  - be compatible with those found in the existing surrounding residential precinct.
  - reflect light between dwellings and heat away from dwellings without undue glare or rogue reflections.
  - avoid harsh contrasts in tone, colour or texture.
  - assist in creating the desired light, bright, warm and cheerful neighbourhood character.
- O92 Provide a backdrop for the desired landscape dominated streetscape.

| Controls |   |
|----------|---|
| C143.    | Wall Materials are to be: <ul style="list-style-type: none"> <li>• Facebrick with appropriate joints, rendered or bag rendered. Masonry, painted, timber or FC weatherboard cladding, painted or approved combinations of the above.</li> <li>• Wall colours are to be light reflective pastel shades. No walls are to be darker than the traditional 'liver brick' found in the precinct.</li> <li>• Strongly mottled facebrick blends are inconsistent with the desired character and are not permitted.</li> <li>• Brick joints are to blend, not contrast, with brickwork.</li> </ul> |
| C144.    | Roof Materials are to be: <ul style="list-style-type: none"> <li>• Tile, slate, shingle, or ribbed metal sheet.</li> <li>• Roof Colours are to be low reflectance.</li> <li>• Glazed finishes and materials causing nuisance glare are not permitted.</li> <li>• Strong colours, mottled blends or flashed tiles are not permitted.</li> </ul>  |
| C145.    | Secondary Elements, trim, eaves, gutters, windows, joinery, etc, can be used to provide contrast in texture and colour to the primary wall and roof surfaces.   |

**Roof Mounted Fixtures**

O93 To avoid unattractive adhoc installations detracting from the roofscape and skyline outlook viewed from vantage points within and beyond the neighbourhood.

| Controls |  |
|----------|--|
| C146.    | No more than one miniature UHF type antenna mounted no higher than 1.5m above the highest point of the roof is permitted per dwelling.                       |
| C147.    | No satellite disc receivers or similar devices are to be installed.  |
| C148.    | Solar collectors are to be mounted at the same pitch as the roof and are not to be visible from the street. Roof mounted water storage units are prohibited. |

**Ancillary Buildings**

O94 To ensure that the visual character of the neighbourhood is not prejudiced by ad-hoc sheds, outbuildings and the like.

| Controls |  |
|----------|--|
| C149.    | No ancillary buildings or structures, including prefabricated sheds, are to be erected on any lot without consent. |



Example of a building and fence design that successfully addresses the public domain and allows for views to and from the street



Wall colours are to be light pastel shades and wall materials can be rendered facebrick, weatherboard or a combination



Example of roof materials and colours that integrate into the neighbourhood and are low reflective/ non-glare

## ESD Principles

### Energy Efficiency

- O95 To achieve energy efficient housing using passive solar design, that provides residents with year-round comfort and reduces energy consumption.

### Solar Access and Orientation

- O96 Orientation, layout and landscape are to make best use of natural ventilation, sunlight and solar energy.

| Controls |  |
|----------|--|
| C150.    | Buildings are to be oriented to maximise solar access to living areas.   |
| C151.    | Windows are to be located and shaded to reduce summer heat load and permit entry of winter sunlight.                                       |
| C152.    | Exterior shading devices are to be used, eg. eaves, balconies, verandas, pergolas, window shutters, adjustable louvres, landscape devices. |
| C153.    | Living areas are to be located to the north side of the dwelling.  |
| C154.    | Sun is to be available to a living area for at least three hours between 9am and 5pm on 21 June (mid winter).                              |

## Building Materials and Landscape

- O97 Materials and insulation are to be selected to assist thermal performance and maintain internal comfort levels.
- O98 To encourage the use of building materials and finishes which maximise the use of renewable energy sources.

| Controls |   |
|----------|---|
| C155.    | High thermal mass materials are to be used for living areas and are to be designed to receive maximum sun during cooler months.   |
| C156.    | Insulation is to achieve an 'R' value (AS 2627.1993) of: <ul style="list-style-type: none"> <li>• R2.0 for roofs and ceilings.</li> <li>• R2.0 for walls - except where the construction materials used embodies an equivalent total R value.</li> </ul>                                |
| C157.    | Deciduous trees are to be planted to provide summer shading and allow winter sun entry.   |
| C158.    | Outdoor clothes drying areas are to be provided with sun and breeze access.   |
| C159.    | Details of finishes, materials and colours are to be submitted to Council with the Development Application.   |
| C160.    | The applicant is to demonstrate that materials used in construction: <ul style="list-style-type: none"> <li>• Maximise renewable resources.</li> <li>• Are energy efficient (low embodied energy).</li> <li>• Are generally non-polluting, durable, recyclable or reuseable.</li> </ul> |
| C161.    | No rainforest timbers or timbers cut from old growth forests are to be used. All timber used on site is to be stamped accordingly.  |
| C162.    | Porous pavers or similar which increase infiltration and reduce stormwater runoffs are to be used on driveways, and pathways wherever possible. The total impervious pavement is not to exceed 25% of the site area.  |

## Ventilation

O99 Building design is to assist internal air movement to provide acceptable thermal conditions.

| Controls |   |
|----------|---|
| C163.    | Dwellings are to be oriented to catch cooling summer breezes.               |
| C164.    | Window and door openings are to be located to facilitate cross-ventilation. |

## Service and Appliances

O100 To maximise energy efficiency and minimise energy consumption.

| Controls |  |
|----------|--|
| C165.    | Development Applications are to demonstrate how energy conservation measures are incorporated in the design, including: <ul style="list-style-type: none"> <li>• Hot water systems using renewable or low pollutant energy sources.</li> <li>• Energy efficient reticulation planning and insulation.</li> <li>• Energy efficient appliances.</li> </ul> |
| C166.    | Energy efficient lighting.   |

## Water Management

O101 To control freshwater consumption by reducing demand and integrating systems and appliances in dwelling design.

| Controls |   |
|----------|---|
| C167.    | New dwellings are to incorporate: <ul style="list-style-type: none"> <li>• Low flow shower roses.</li> <li>• Dual flush toilets.</li> <li>• Water efficient washing machines.</li> <li>• Irrigation systems, if used, that are micro or drip type soil moisture sensor controlled.</li> </ul> |
| C168.    | A storm water management plan is to be submitted with the development application.  |

## Waste Management

O102 To provide adequate waste storage facilities and to facilitate recycling with a view to minimising waste entering land fills.

| Controls |  |
|----------|--|
| C169.    | Development Applications are to indicate: <ul style="list-style-type: none"> <li>• Adequate space for at-source separation of waste within each dwelling.</li> <li>• Facilities for storing recyclable and waste products in locations which are not directly visible or are screened from public areas and which do not pose a threat of noise, odour or safety and which are readily accessible to Council's waste contractors.</li> </ul> |

## Definitions

**Wall Height:** Is measured vertically from the Natural Ground Level to the highest of the following: underside of the eaves, guttering, parapet, capping, and top of wall or wall plate supporting roof framing.

**Primary Frontage:** The primary street frontage is the lot frontage edged heavy black on the DCP Map ([fig 1](#))

**Secondary Frontage:** A corner lot boundary fronting a street other than a primary street frontage.

# K5 Cape Cabarita



Figure K5-1 Aerial photo (source: nearmap.com)



Figure K5-2 Council area map

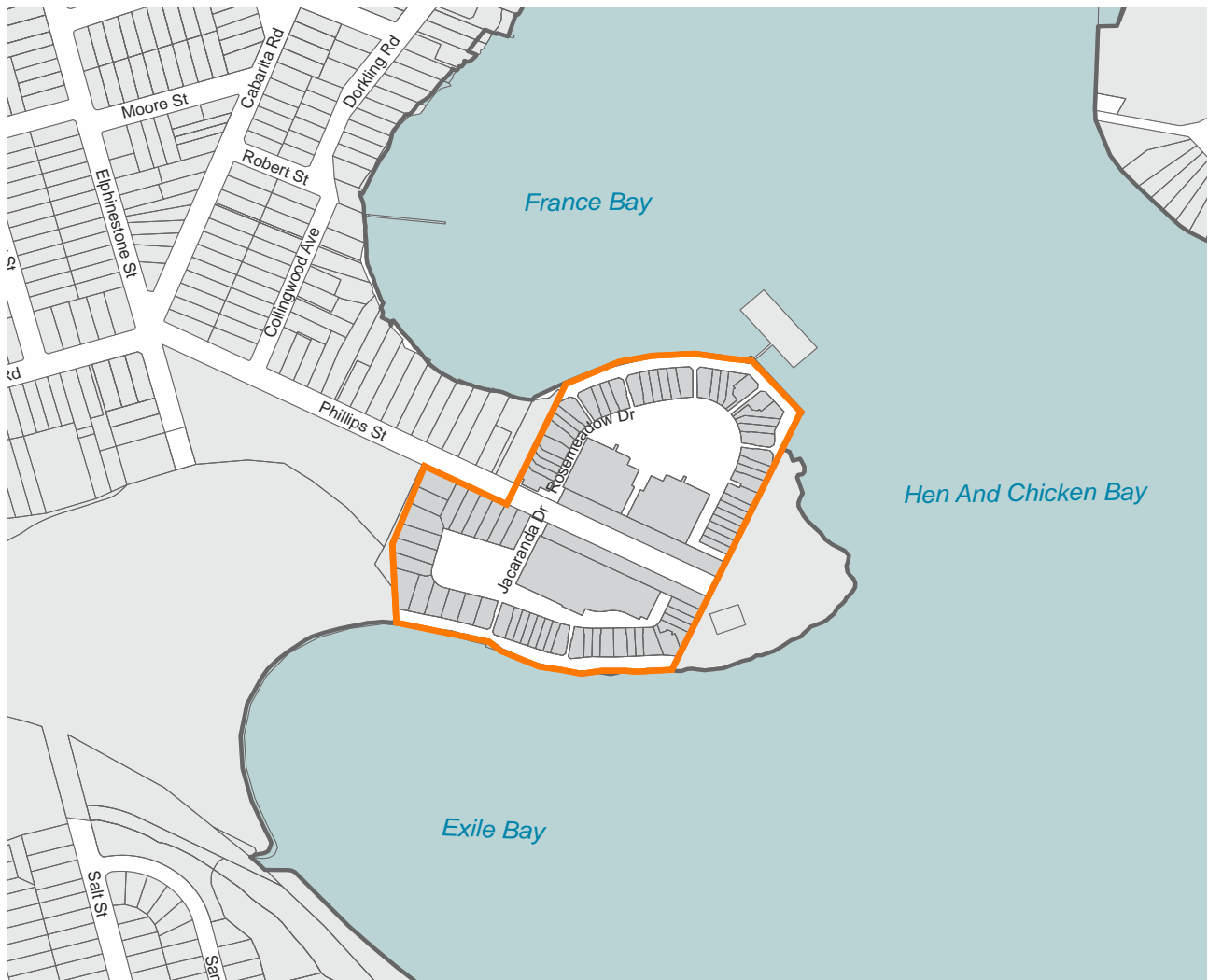

Figure K5-3 Cape Cabarita - Location Plan



## K5.1 General objectives

- O1 Provide a pleasant, functional and safe environment to and along the foreshore for cyclists and pedestrians;
- O2 Maintain significant views and vistas into and out of the site;
- O3 Ensure adequate provision of landscaping and usable private and public open space;
- O4 Provide for pedestrian and cycle linkage through the site to adjoining areas;
- O5 Maximise visual and acoustic privacy to adjoining properties and within the development itself;
- O6 Ensure adequate daylight and sunlight are maintained to existing development, new development and open spaces;
- O7 Ensure the existing streetscape character is enhanced;
- O8 Ensure development and access networks are integrated with the existing built and natural environment;
- O9 Ensure development presents an appropriate bulk and scale to public areas having regard to existing development and the topography of the site; and
- O10 Ensure the design orientation of buildings and materials used in construction utilise renewable resources.

## K5.2 Specific provisions

### Design and Siting - Streetscape

#### Objective

- O11 To integrate new development in a manner which complements the character of the area and relates to the pedestrian environment.

#### Controls

|     |   |
|-----|---|
| C1. | Development on public street frontage has had regard to the character of existing development in the vicinity of the site including: <ul style="list-style-type: none"> <li>• setbacks of existing buildings on Cabarita Road;</li> <li>• landscaping;</li> <li>• fence height;</li> <li>• spaces between dwellings;</li> <li>• views through the site; and</li> <li>• roof pitch.</li> </ul>   |
| C2. | New development and fences contribute to and is integrated into the overall streetscape at a scale which relates to the pedestrian environment.   |
| C3. | Building height plane to apply from the existing boundary with Phillips Street.   |
| C4. | Buildings are to be setback a minimum of 9 metres from the Phillips Street frontage.  |
| C5. | Building facades are to be orientated towards public street frontages (See Figure K5-5 Site Controls).  |
| C6. | Buildings are not to exceed the following (See Figure K5-5 Site Controls): <ul style="list-style-type: none"> <li>• 5 storeys in height along the Phillips Street frontage;</li> <li>• 3 storeys in height adjoining Massey Park Golf Course; and</li> <li>• 2 storeys in height adjacent to the boundaries with No.31 Phillips Street, Prince Edward Park and the waterfront areas.</li> </ul> |
| C7. | Fences having frontage to public open space or public roadway are: <ul style="list-style-type: none"> <li>• not to exceed 1 metre in height of solid construction; and</li> <li>• not to exceed 1.8 metres if of 'open' type design.</li> </ul>   |
| C8. | Continuous wall and/or fencing for more than 20 metres should have some visual or physical relief.  |
| C9. | Seating areas in a landscaped setting are to be provided every 100 metres along the frontage.   |

## Side boundaries

### Objective

O12 To minimise the impact of new development on adjoining areas.

| Controls |   |
|----------|---|
| C10.     | Buildings adjoining side boundaries will not adversely impact on the amenity enjoyed by existing adjoining dwellings. Consideration has to be given to: <ul style="list-style-type: none"> <li>• maintaining of views;</li> <li>• overshadowing of private open space to give visual relief;</li> <li>• minimising the impact of bulk and scale of new development on adjoining areas;</li> <li>• fence design and height relates to and does not detract from Cabarita Park;</li> <li>• buildings are separated or articulated and do not present blank walls; and</li> <li>• maintenance of privacy.</li> </ul> |
| C11.     | Compliance should be achieved with the building height plane (see Figure K5-6 Building Height Plane Diagram).   |
| C12.     | Fences adjoining Prince Edward Park should not exceed 1.8 metres in height and be of 'open' appearance.   |

## Foreshore Frontage

### Objective

O13 To ensure the integrity of the foreshore is maintained and enhanced for public enjoyment

| Controls |  |
|----------|--|
| C13.     | Development along the foreshore contributes to the character of the foreshore. The development has had regard to: <ul style="list-style-type: none"> <li>• minimising the visual impact of development as viewed from the water and the foreshore access way;</li> <li>• creating a visually integrated environment which contributes to a sense of safety and security for users of the public open space, (see also 'Access and Landscaping' sections);</li> <li>• the provision of cycleways, pedestrian pathways; and</li> <li>• providing appropriate street furniture, lighting and planting for the comfort, safety and security of users.</li> </ul> |
| C14.     | Building height plane to apply from the property boundary.   |
| C15.     | An average setback of 13.5 metres, having a minimum width of 9 metres, is to be provided from the high water mark to the development for a public foreshore accessway (see Figure K5-5 Site Controls).   |
| C16.     | Buildings are to be setback a minimum of four metres from the public foreshore accessway.  |
| C17.     | The location of buildings should not result in overshadowing to the foreshore between the hours of 9am to 3pm (EST) or 10am to 4pm (Daylight saving time).   |
| C18.     | The foreshore access is to be in a landscaped setting and comprise: <ul style="list-style-type: none"> <li>• a pedestrian pathway with minimum dimensions of 1.0 metre; and</li> <li>• a cycleway with minimum dimensions of 0.8 metres with a separation distance of 0.7 metres.</li> </ul>   |

## Height of Building

### Objective

O14 To ensure the building envelope relates to the topography of the site, providing an appropriate bulk and scale, having regard to the foreshore location, streetscape and adjoining properties.

| Controls |   |
|----------|---|
| C19.     | <p>Building height has had regard to:</p> <ul style="list-style-type: none"> <li>• maintenance of significant views from buildings to public areas;</li> <li>• topographic variation minimising visual impact as viewed from the water, streetscape and public open spaces and conformity with the treeline along the Cabarita Road frontage;</li> <li>• overshadowing of open spaces and other buildings;</li> <li>• setbacks from adjoining developments;</li> <li>• character of the surrounding area; and</li> <li>• the human scale and relationship to open space.</li> </ul> |
| C20.     | <p>Buildings should not exceed the building height plane on all boundaries and development should be no higher than:</p> <ul style="list-style-type: none"> <li>• 5 storeys within a distance of 50 metres from Phillips Street Subject to the height restrictions placed on other boundaries; and</li> <li>• the ceiling height for buildings greater than two storeys shall be no greater than 2.7 metres (see Figure K5-5 Site Controls and Figure K5-6 Building Height Plane Diagram).</li> </ul>   |

## Bulk and scale

### Objective

O15 To ensure the location, layout and design of buildings has regard to the impact of development on views from surrounding public spaces and within the development.

| Controls |  |
|----------|--|
| C21.     | <p>The development has had regard to:</p> <ul style="list-style-type: none"> <li>• massing to reduce its visual impact from open spaces, roadways and the Parramatta River;</li> <li>• separation between buildings should provide view corridors through the site;</li> <li>• privacy between buildings; and</li> <li>• providing a reasonable level of solar access to dwellings and open spaces.</li> </ul> |
| C22.     | <p>Buildings comply with the building height plane, floor space ratio, and landscaping provisions.</p>   |

## Building Design

### Objective

O16 To ensure a high quality design which is integrated into the existing environment

| Controls |  |
|----------|--|
| C23.     | <p>The design of buildings:</p> <ul style="list-style-type: none"> <li>• provides variety and presents as a cohesive development;</li> <li>• includes architectural features which reflect the character of Concord (see also street frontage and shading); and</li> <li>• garages and carparks are not intrusive or visually dominant.</li> </ul> |
| C24.     | <p>Generally, buildings are to have pitched roof forms.</p>  |
| C25.     | <p>Access driveways are to provide a landscaped entry.</p>   |
| C26.     | <p>Solar hot water tanks are to be located within the roofspace of development.</p>  |



## Views

### Objective

O17 To maintain views through the site from public spaces.

#### Controls

|      |  |
|------|--|
| C27. | Buildings are designed to: <ul style="list-style-type: none"> <li>• maximise views of Parramatta River and public open space within and throughout the development;</li> <li>• minimise obstruction of views from other buildings; and</li> <li>• provide vistas.</li> </ul> |
| C28. | A view corridor is to be maintained from Phillips Street, through the development to the foreshore on both sides.  |

## Paved Areas

#### Controls

|      |  |
|------|--|
| C29. | Porous pavers or similar treatment which increases infiltration and reduces stormwater runoffs is used extensively on driveways, pedestrian access routes and for pathways in public and private outdoor open space. |
| C30. | The total impervious surfaces used for vehicular access driveways are not to exceed 10% of the total site area.  |

## Landscaping and Open Space

### Objective

O18 To ensure adequate and appropriate provision of usable private, communal and public open space and landscaping to meet all user needs, having regard to microclimate, security, safety, privacy, visual appearance and biodiversity.

#### Controls

|      |   |
|------|---|
| C31. | Landscaping should have regard to: <ul style="list-style-type: none"> <li>• retention of significant vegetation, which is not affected by the remediation of the site;</li> <li>• the relationship between buildings and open spaces;</li> <li>• enhancing pathway and street connections within the site and between adjoining sites;</li> <li>• providing privacy to adjacent development;</li> <li>• location and function of open space</li> <li>• providing for thermal comfort of the users in terms of shade and shelter;</li> <li>• using native species, where appropriate;</li> <li>• surveillance of communal open;</li> <li>• enhancing the visual appearance of the development;</li> <li>• differentiating between private and public open space;</li> <li>• assists in stormwater management; and</li> <li>• complements the materials and colours used in the development.</li> </ul> |
|------|---|

## Open Space provision

### Objective

O19 To provide quality open space for the enjoyment of users.

#### Controls

|      |   |
|------|---|
| C32. | Open space includes: <ul style="list-style-type: none"> <li>adequate pedestrian and cycle linkages through the development and along the foreshore;</li> <li>communal spaces which have access to sunlight for year round use;</li> <li>landscaping to enhance the amenity of the environment and enjoyment of the users;</li> <li>promoting a sense of security and safety for users;</li> <li>provides for passive and active recreational needs for the residents; and</li> <li>has regard to the heritage items on the site.</li> </ul> |
| C33. | A landscaped area of 50% of the site area.  |

## Public Foreshore Access

### Objective

O20 To provide foreshore access which is clearly identifiable for public use.

#### Controls

|      |  |
|------|--|
| C34. | Public foreshore access is appropriately landscaped to minimize the impact of development as viewed from the water. The entrances to the foreshore are designed to reinforce its public accessibility. |
| C35. | Directional signage is to be provided at the entrance to the foreshore path.   |

## Public and Communal Open Space

#### Controls

|      |  |
|------|--|
| C36. | Open space follows pedestrian/cycle desire lines through the site creating visually appealing spaces for both passive and active recreation. |
|------|--|

## Private Open Space

### Objective

O21 To ensure adequate usable private open space to meet the needs of residents

#### Controls

|      |  |
|------|--|
| C37. | The development provides usable private open space which is of sufficient dimensions having regard to the size of the dwelling and: <ul style="list-style-type: none"> <li>allows for outdoor seating and dining;</li> <li>provides outdoor drying facilities screened from public view; and</li> <li>provides for landscaping at ground level.</li> </ul>   |
| C38. | For above ground development, the open space may take the form of a balcony directly connected to the dwelling with the following minimum requirements: <ul style="list-style-type: none"> <li>1 bdr - minimum area of 6m<sup>2</sup> having a minimum dimension of 2m;</li> <li>2 bdr - minimum area of 8m<sup>2</sup> having a minimum dimension of 9m; and</li> <li>3 bdr or greater - minimum area of 12m<sup>2</sup> having a minimum dimension of 2m.</li> </ul> |
| C39. | For development at ground level the following requirements apply: <ul style="list-style-type: none"> <li>1 bdr - minimum area of 10m<sup>2</sup> having a minimum dimension of 3m;</li> <li>2 bdr - minimum of 16m<sup>2</sup> having a minimum dimension of 4m; and</li> <li>3 bdr or greater - minimum area of 35m<sup>2</sup> having a minimum dimension of 4m.</li> </ul>  |

### Lighting

#### Objective

O22 To provide lighting which enhances the security and appearance of the development

| Controls |   |
|----------|---|
| C40.     | <p>The applicant has demonstrated that provision has been made for adequate lighting which enhances the appearance of the development and maximises security of:</p> <ul style="list-style-type: none"> <li>• building entrances;</li> <li>• public spaces and pathways;</li> <li>• driveways and carparks; and</li> <li>• without impacting on adjoining properties</li> </ul> |

### Car Parking Provision

#### Objective

O23 To ensure adequate, safe and convenient provision of parking, cycle facilities and pedestrian access which is integrated into the overall design of the site and adjoining areas.

| Controls |  |
|----------|--|
| C41.     | <p>Adequate parking is provided having regard to:</p> <ul style="list-style-type: none"> <li>• existing and future public transport provision;</li> <li>• cyclist and pedestrian linkages through the site to adjoining areas;</li> <li>• efficient and effective entry and egress to the sites;</li> <li>• adequate resident and visitor carparking and parking for disabled;</li> <li>• adequate bicycle storage facilities; and</li> <li>• safe, convenient parking and access which minimises conflicts between motorist, cyclists and pedestrians.</li> </ul> |

|      |  |
|------|--|
| C42. | Secure resident parking spaces are to be provided for all dwellings in apartment buildings at basement level with internal access to the development.                        |
| C43. | Secure resident parking spaces may be provided in ground level enclosed garages for attached or detached dwellings at ground level.  |
| C44. | Basement car parking is to be generally naturally ventilated and have access to some natural lighting.   |
| C45. | Parking spaces located above ground are in a landscaped setting, and are not directly visible from the Phillips Street frontage.   |
| C46. | Parking is not permitted between the building and street alignment. Parking shall be in the form of a garage, basement car park, covered carport or an equivalent open area. |
| C47. | Entry driveways are in a landscaped setting with the appearance of being open and accessible.  |
| C48. | Security gates are not to be installed at entry and exit points into the development   |

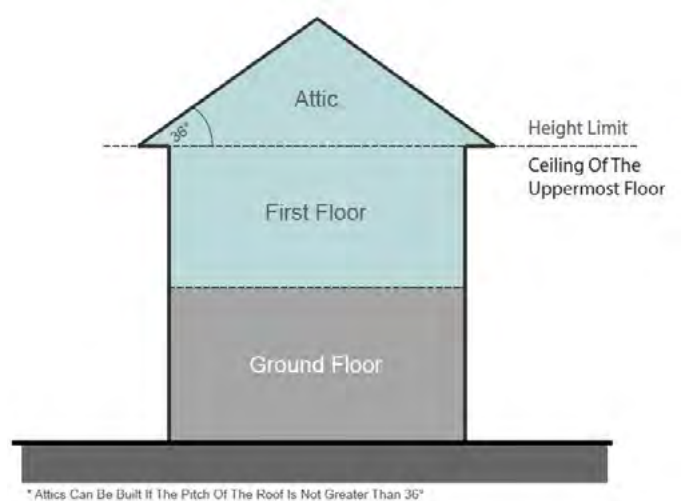

Figure K5-4 Attic Pitch Controls

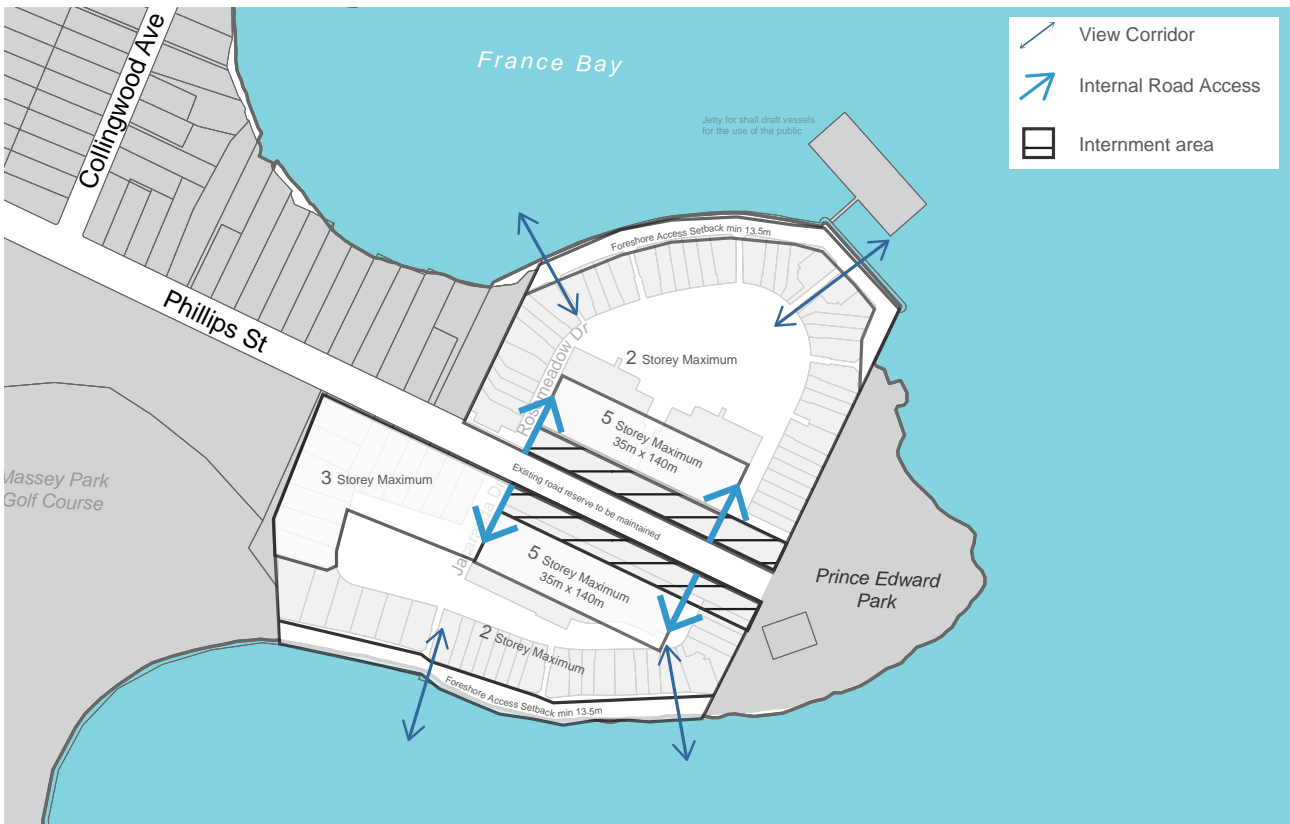
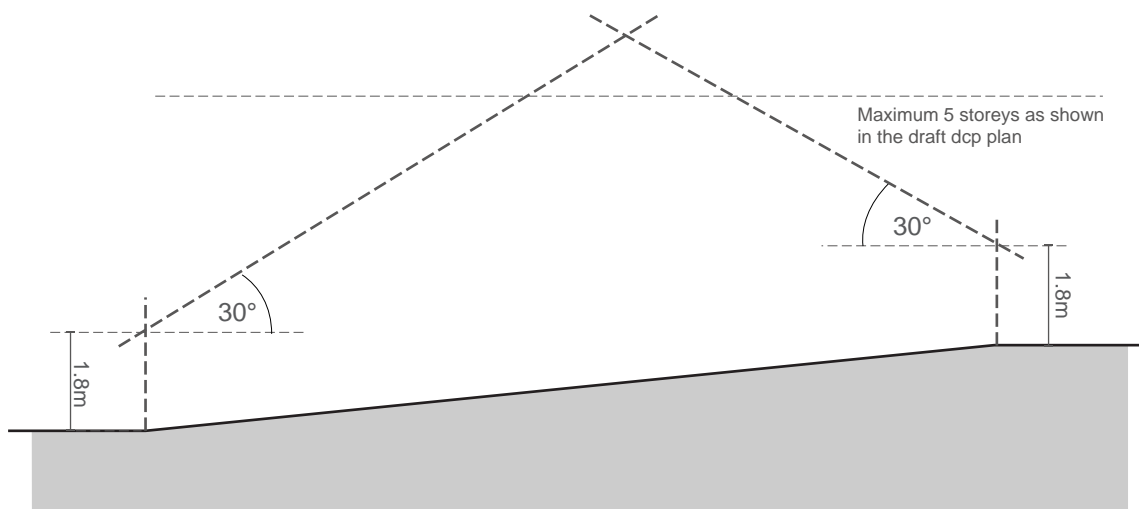
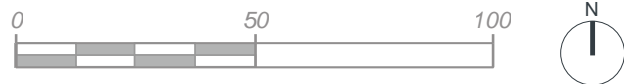

Figure K5-5 Site Controls



\* Building height plane applies to all boundaries in this precinct

Figure K5-6 Building Height Plane Diagram

## K6 Concord West

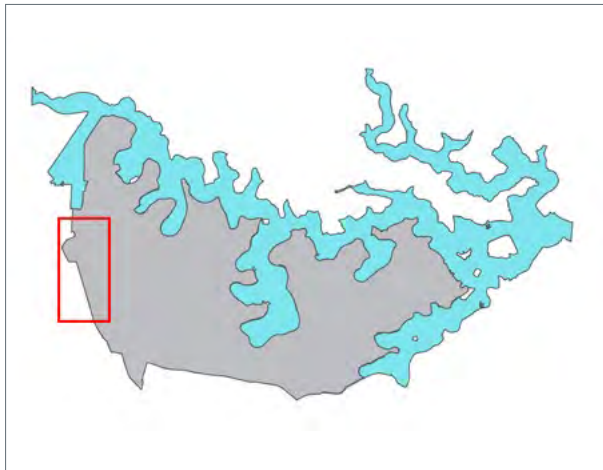

Figure K6-1 Council area map

### K6.1 Introduction

#### Context

The Concord West Precinct (the Precinct) is bound by Liberty Grove to the north, Pomeroy Street to the south, the main Northern Railway Line to the east and Powell's Creek Reserve to the west. The area is characterised by a variety of built form and uses, including a mix of dwelling houses, town houses, apartment buildings, education and industrial uses. In terms of vehicle movement the precinct is effectively self-contained, with George Street forming the only vehicular access point to the surrounding road network at the southern end of the precinct.

Studies have identified a number of industrial sites within the precinct that are currently underutilised. The identified sites are well suited for residential purposes, featuring good access to public transport and local amenities.

#### Land to which this section of the DCP applies

This section provides development controls for specific areas addressed within the adopted Concord West Precinct Master Plan, Urban Design Study (May 2014). Currently, this section of the DCP applies only to the area/s listed below:

- Sub-Precinct 3, where the land is located at 3 King Street, Concord West (see Figure K6-2 Location Plan).
- Sub-Precinct 6, where the land is located at 2, 2A and 4 Rothwell Ave, Concord West (see Figure K6-2 Location Plan).
- Sub-Precinct 7, where the land is located at 25 George Street, Concord West (see Figure K6-2 Location Plan).

#### Desired Future Character

The desired future character of the precinct is a transit oriented community which features higher densities that maximise site renewal opportunities. Development proposals in the precinct are to achieve the following desired future characteristics:

- **Well Integrated Built Form:** Development will provide a considerate built form that steps down in height toward adjoining lower-rise residential areas. The siting, bulk and scale of development will ensure there are no significant adverse impacts to sunlight access and privacy within the precinct.
- **Mixed Use:** Development adjoining the public square will provide a focal point for the neighbourhood by providing active uses such as shops, cafes and restaurants.
- **Accessibility:** Development will better connect the precinct as a whole by creating a permeable street network for pedestrians and vehicles. Connections will strengthen existing or promote new routes to the station and open space.

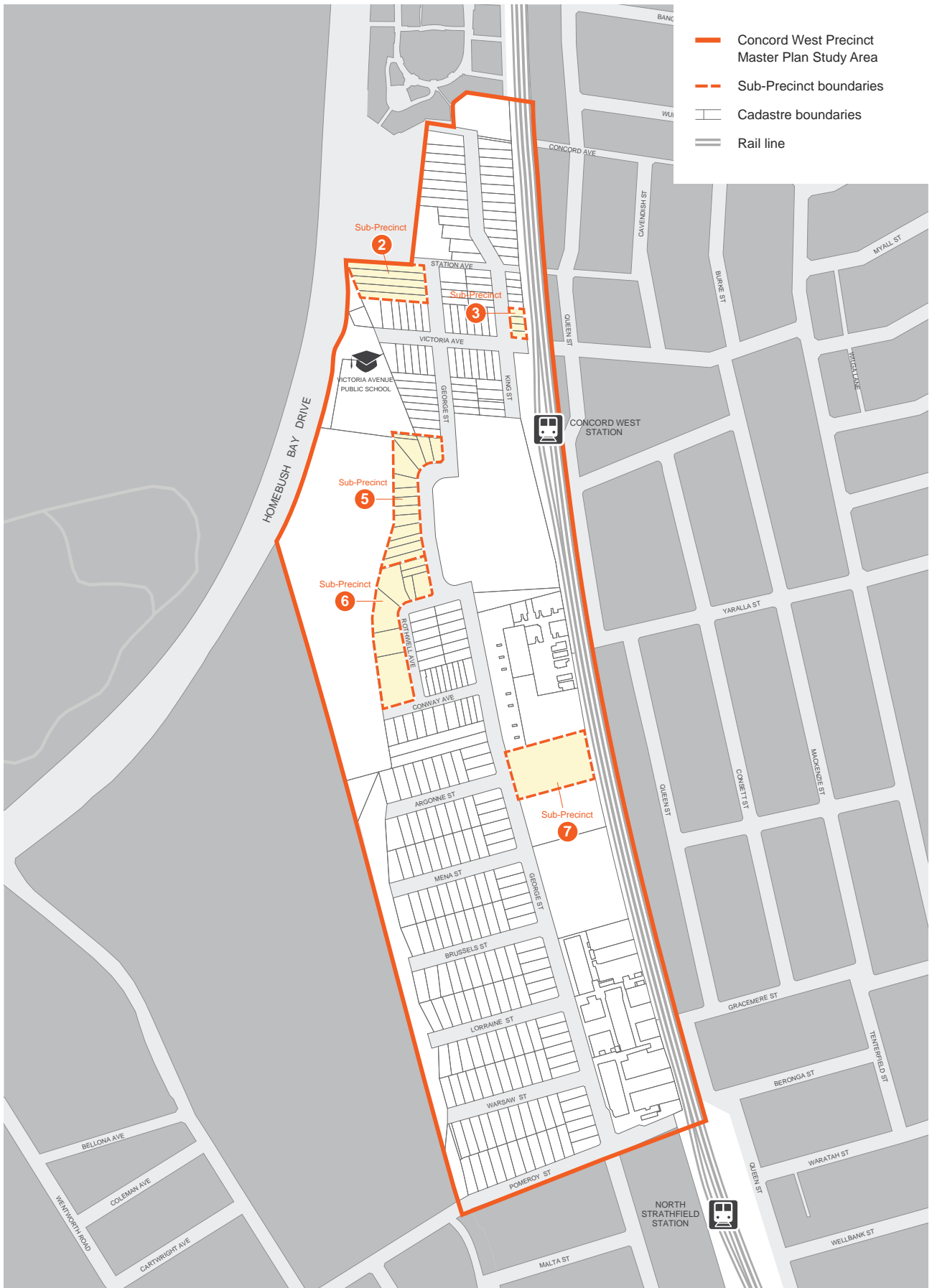

Figure K6-2 Location Plan

0 50 200m



## K6.2 Public Domain and Movement

### Pedestrian and Cycle Connections

#### Objectives

- O1 To improve pedestrian connectivity to open space and the Canada Bay Public School.
- O2 To create new access routes through sites to strengthen the connections to and between places.
- O3 To better connect the neighbourhood as a whole.
- O4 To make it easier and more attractive to walk and cycle through the neighbourhood.
- O5 To improve access to public transport and nearby commercial and retail areas.

| Controls |  |
|----------|--|
| C1.      | Provide a new pedestrian connection between the western end of Station Avenue and the western end of Victoria Avenue within the area identified in Figure K6-3 Public Domain Plan. |
| C2.      | Provide multiple mid-block pedestrian connections between George Street and the playing fields within the area identified in Figure K6-3 Public Domain Plan.                       |
| C3.      | Provide a new mid-block pedestrian connection between Rothwell Avenue and Powells Creek Reserve within the area identified in Figure K6-3 Public Domain Plan.                      |
| C4.      | All new pedestrian connections are to be a minimum 10 metres wide  |
| C5.      | All pedestrian connections and footpaths are to be publicly accessible 24 hours a day through access easements.  |
| C6.      | All new pedestrian connections are to be consistent with Safer-by-Design (or CPTED) principles (i.e. clear lines of sight).  |
| C7.      | Implement kerb build outs at intersections and other key pedestrian crossings to narrow the width of the street.   |
| C8.      | Provide an on-road or separated cycle path along George Street and King Street from Pomeroy Street to Liberty Grove as identified in Figure K6-3 Public Domain Plan.               |
| C9.      | Provide for new footpaths as indicated in Figure K6-3 Public Domain Plan.  |

## New Shareways

### Objectives

- O6 To improve connectivity and make it easier for people to walk through the neighbourhood.
- O7 To integrate future development sites into the existing neighbourhood fabric.

### Controls

|      |  |
|------|--|
| C10. | Provide a new north-south share way connecting Concord Avenue to Station Avenue which: <ul style="list-style-type: none"> <li>• has built form between the share way and the eastern boundary; and</li> <li>• is publicly accessible.</li> </ul> |
| C11. | Extend Station Avenue to the west as a share way to provide vehicular access to adjacent buildings and pedestrian access to the pedestrian network as identified in Figure K6-3 Public Domain Plan.  |
| C12. | The new extended Station Avenue is to provide unobstructed views from the pedestrian tunnel under the rail line to Homebush Bay Drive.   |
| C13. | Upgrade Concord Avenue and Station Avenue west of King Street to provide a seamless continuation of the share way as identified in Figure K6-3 Public Domain Plan.   |
| C14. | All share ways are to be publicly accessible 24 hours a day through access easements.  |

## Public Open Space

### Objectives

- O8 To give the neighbourhood a meeting place and focal point.
- O9 To create a George Street and King Street 'spine' to visually unify the character of the neighbourhood.

### Controls

|      |   |
|------|---|
| C15. | Provide a public square at the end of Victoria Avenue in front of the railway station as identified in Figure K6-3 Public Domain Plan. The public square is to: <ul style="list-style-type: none"> <li>• have a minimum area of 400m<sup>2</sup>.</li> <li>• have minimum dimensions of 17m x 18m; and</li> <li>• feature characteristics for passive recreation such as hardstand paving, tree planting to provide shade, lighting and seating.</li> </ul> |
| C16. | Tree planting on the verge of George Street and King Street from Pomeroy Street to Liberty Grove is to feature: <ul style="list-style-type: none"> <li>• Regularly spaced planting of trees; and</li> <li>• Planting of consistent tree species.</li> </ul>   |
| C17. | Kerb build outs are to include rain gardens or low level landscaping where appropriate.   |



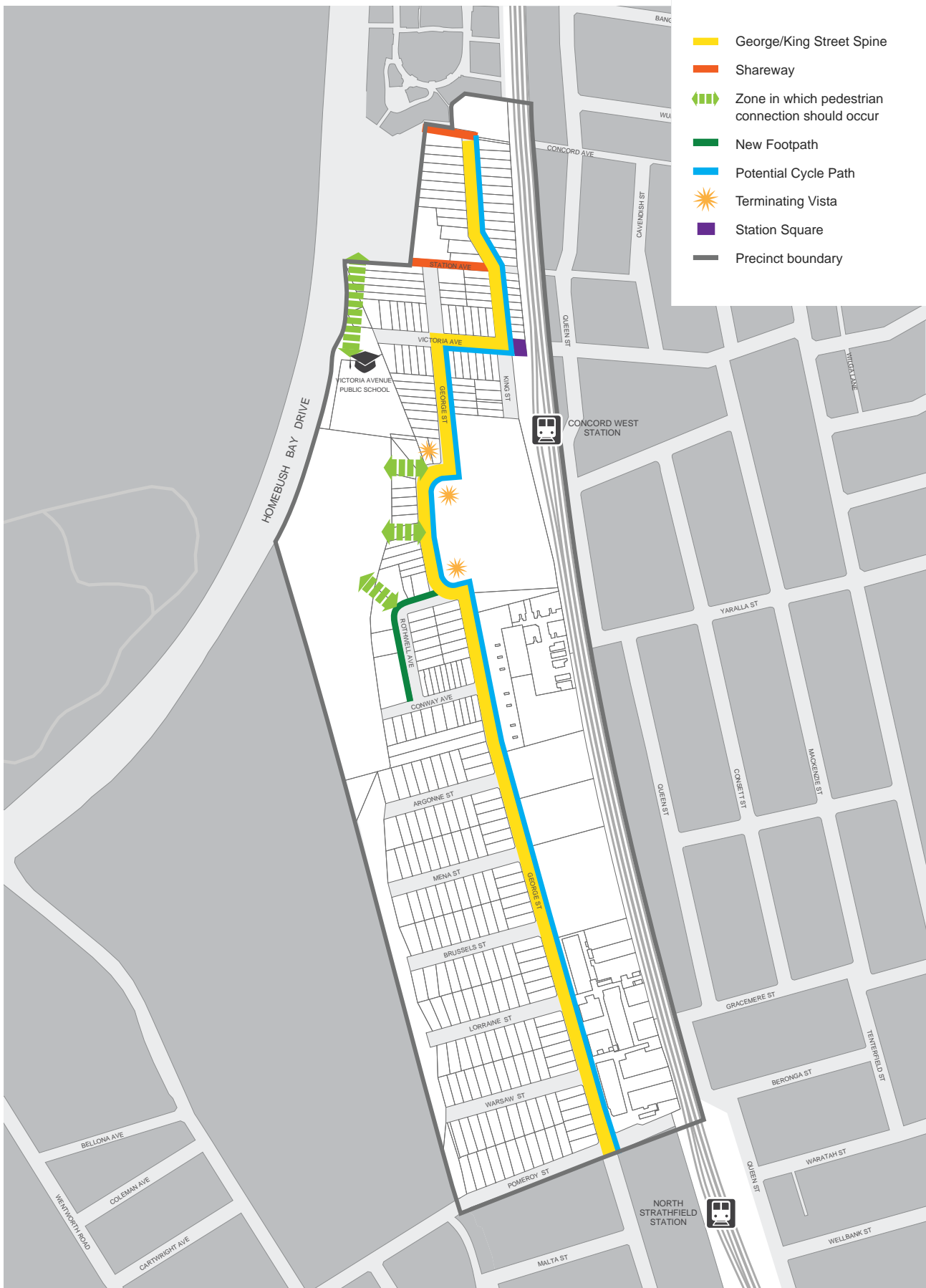

Figure K6-3 Public Domain Plan

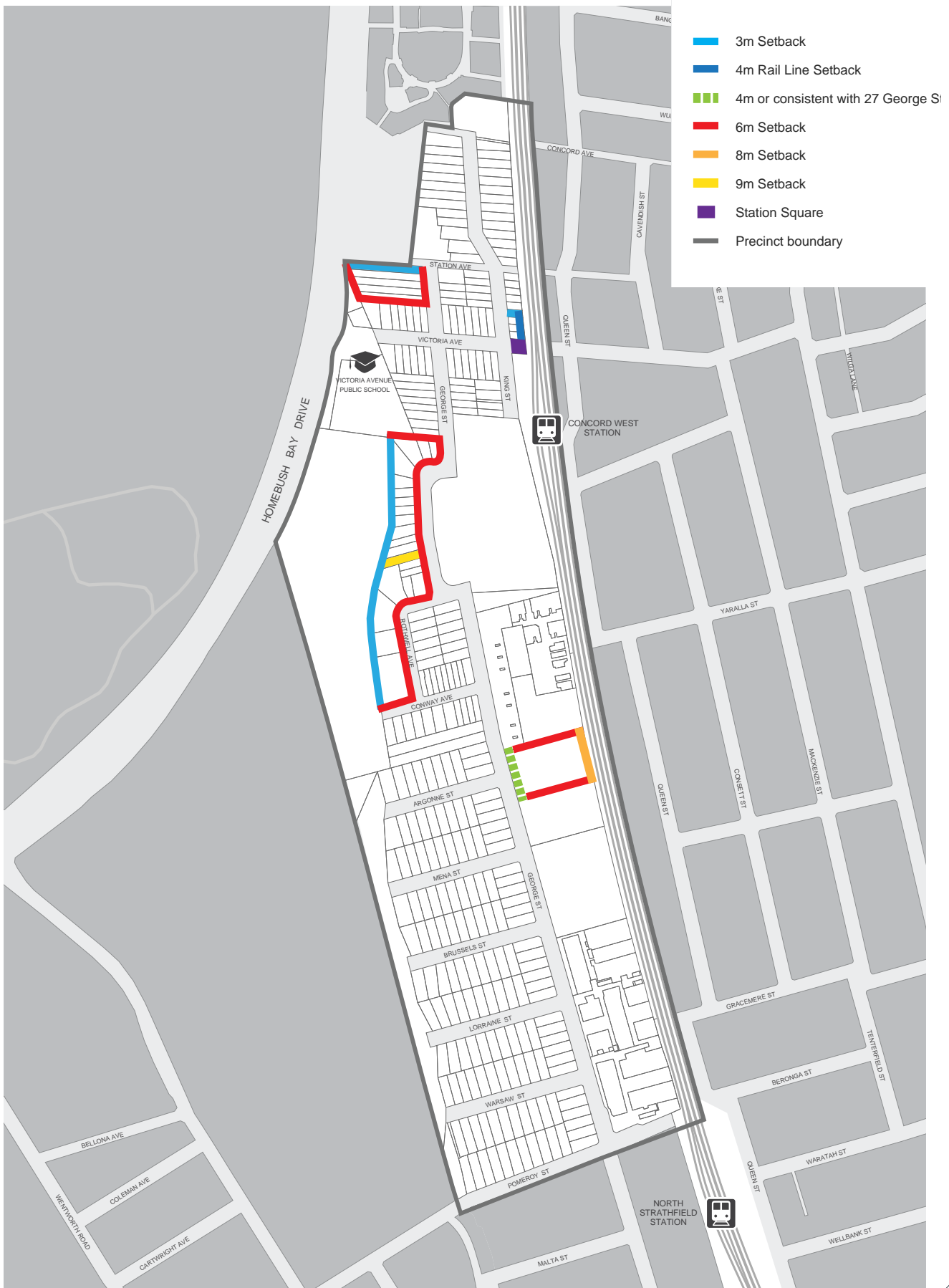

Figure K6-4 Primary Setbacks Plan

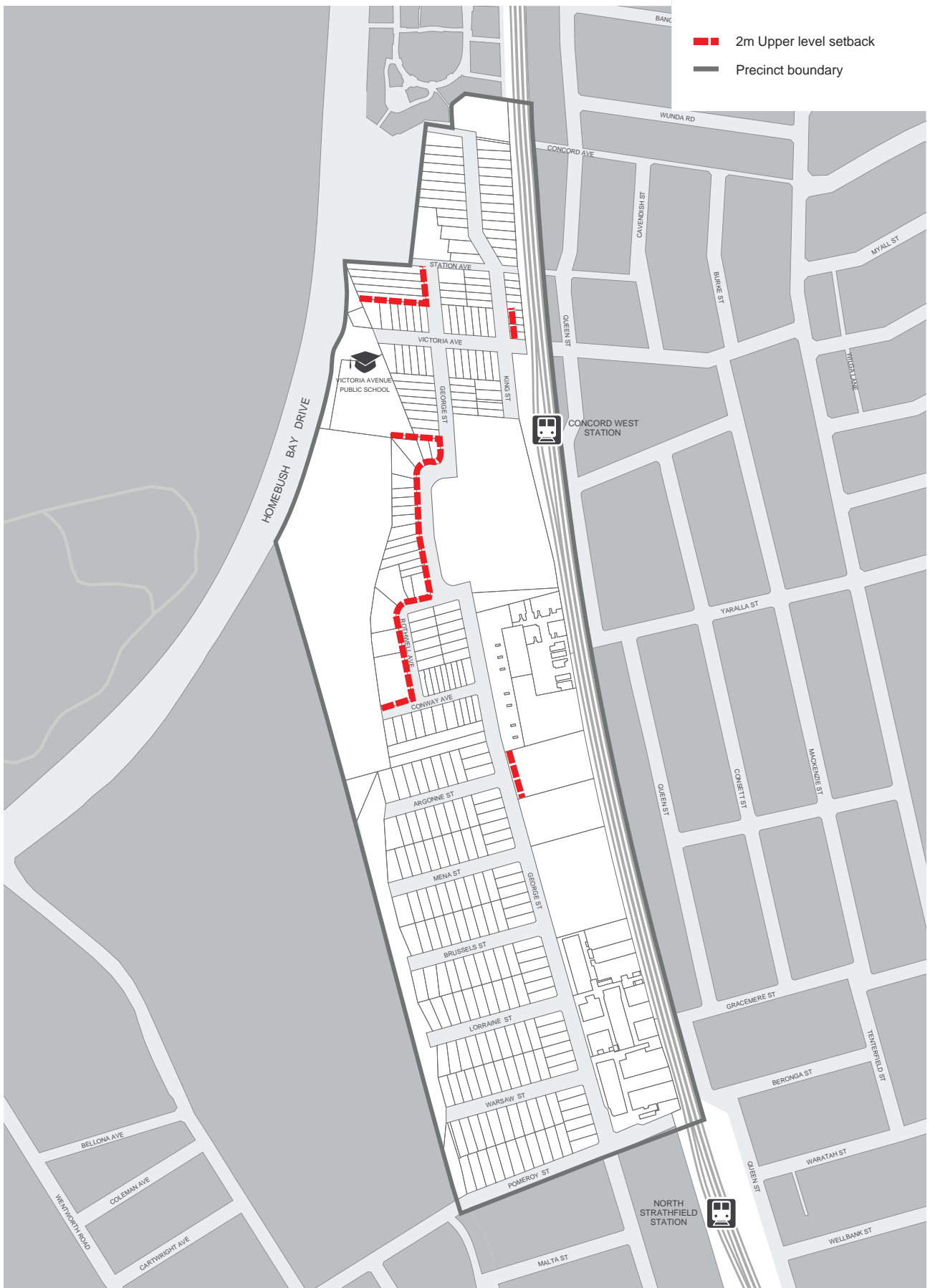

Figure K6-5 Secondary (Upper Level) Setbacks Plan



Figure K6-6 Maximum Building Heights Plan

## K6.3 Built Form

### Building Setbacks

#### Objectives

O10 To minimise the impact of new development on existing development.

| Controls |  |
|----------|--|
| C18.     | Development setbacks are to be in accordance with Figure K6-4 Primary Setbacks Plan.   |
| C19.     | The upper most level of new development four storeys or higher is to provide a 2 metre setback in accordance with Figure K6-5 Secondary (Upper Level) Setbacks Plan. |
| C20.     | The area within the primary setback of the street frontage is to be a deep soil zone and is to have no structures below.   |
| C21.     | Access points to underground parking are encouraged to be located between existing and new development if that will provide for increased building separation.       |

### Building Height

#### Objectives

O11 To allow redevelopment while at the same time respecting the existing character of the neighbourhood.

| Controls |   |
|----------|---|
| C22.     | New buildings are to be consistent with Figure K6-6 Maximum Building Heights Plan. <i>Note: Maximum building heights are to be in accordance with the LEP. This control provides further, more detailed guidance, and is intended to articulate building height in storeys to better achieve the objective of this point, in particular minimising negative impacts on existing development.</i>        |
| C23.     | Development at Sub-Precinct 2 must provide a building height transition zone with a maximum of 4 storeys on land fronting George Street and adjacent to rear boundaries of adjoining properties facing Victoria Avenue. The maximum height of 6 storeys is to be provided towards the north-west corner of the site. Refer to Figure K6-8 Section C-C and Figure K6-9 Section D-D for more information. |
| C24.     | Development at Sub-Precinct 3 is not to exceed two storeys within 10 metres of its northern property boundary. Refer to Figure K6-11 Section E-E for more information.  |
| C25.     | A maximum height of 6 storeys in Sub-Precinct 5 is to be limited to the portion of the site south of Lot 7 in DP 15973. A building height transition zone with a maximum height of 4 storeys is to be provided to the north of (and inclusive of) Lot 7 in DP 15973. Refer to Figure K6-13 Section F-F for more information.  |
| C26.     | The maximum 4 storey transition height as shown on Figure K6-18 Section J-J for Sub-Precinct 7 shall have a setback of 30m from the front boundary. The setback shall be consistent with the rear building line of the street facing building on adjoining allotments.  |

## Building Articulation

### Objectives

O12 To provide well-articulated built form that reduces the visual bulk and scale of buildings.

#### Controls

|      |   |
|------|---|
| C27. | Where a building is greater than 60 metres in length the facade is articulated through the use of: <ul style="list-style-type: none"> <li>• significant recesses or projections.</li> <li>• deep balconies.</li> <li>• elements of a finer scale than the main structural framing including the eaves and overhangs.</li> <li>• vertical elements such as blade walls or fins.</li> </ul> |
|------|---|

## Ground Floor Residential

### Objectives

O13 To ensure ground floor dwellings have a high level of amenity and create a positive interface with the street.

O14 To provide for increased passive surveillance of the public domain.

#### Controls

|      |   |
|------|---|
| C28. | Dwellings on the ground floor facing the street are to have individual entries from the street.   |
| C29. | Ground floor private open space is to be designed as a private terrace.<br><i>Note: The area and dimension of private open space is to be consistent with Part 6 (6.4.6) of the Canada Bay DCP.</i> |
| C30. | Where fronting a pedestrian connection, ground floor dwellings are to be designed to maximise passive surveillance.   |

## Ground Floor Mixed Use

### Objectives

O15 To promote activity and interest and enhance the public domain, particularly at Station Square

O16 To provide the community with a focal point.

O17 To enhance safety and security at the station.

O18 To provide for increased passive surveillance of the public domain.

#### Controls

|      |  |
|------|--|
| C31. | Provide ground level active uses where fronting Station Square (see Figure K6-11 Section E-E).<br><i>Note: Active uses that are encouraged include Cafes, Restaurants and the like.</i>  |
| C32. | Where fronting station Square development is to engage and activate the square through design measures that may include: <ul style="list-style-type: none"> <li>• public seating that spills into the square.</li> <li>• design measures that enable an open frontage at ground level to the square; and</li> <li>• awnings that encourage the public to spend time during all weather types.</li> </ul> |

## K6.4 General

### Flooding

#### Objectives

O19 To mitigate potential flood impacts on new and existing development.

#### Controls

|      |  |
|------|--|
| C33. | New development is to be consistent with the findings, conclusions and recommendations of the Concord West Precinct Master Plan Flood Study. |
|------|--|

### Important Views

#### Objectives

O20 To ensure new development enhances vista opportunities.

#### Controls

|      |  |
|------|--|
| C34. | <p>New development at terminating vista sites shown in Figure K6-3 Public Domain Plan are to include features or articulation to provide visual interest which may include:</p> <ul style="list-style-type: none"> <li>• Expressive roof features.</li> <li>• Emphasised vertical elements.</li> <li>• Façade elements which vary in colour or in material type from those used at other parts of the building.</li> </ul> |
|------|--|

### Passive Surveillance

#### Objectives

O21 To increase passive surveillance of public open space.

O22 To encourage public use of open space by providing a safe environment.

#### Controls

|      |   |
|------|---|
| C35. | <p>Where fronting Powell’s Creek Reserve, the Canada Bay Primary School playing fields or Olympic Park, development is to engage and activate open space through layout and design measures which include:</p> <ul style="list-style-type: none"> <li>• Orienting living areas and areas of principal open space toward open space, having large, transparent windows facing the open space.</li> <li>• Avoid dense screen vegetation within private open space.</li> <li>• Increasing opportunities for passive surveillance.</li> <li>• Avoiding large / expansive walls.</li> <li>• Providing low or transparent fencing.</li> <li>• Avoiding significant grade change of built form.</li> </ul> |
|------|---|

**Example Built Form Sections**

**Sub-Precinct 2**

**George Street Interface**

Section C-C below illustrates height transition and upper level setback to George Street.



Figure K6-7 Key Plan Sub-Precinct 2



Figure K6-8 Section C-C

**Interface Station Avenue**

Section D-D depicts the principle of four storey built form where adjacent to existing housing and where the top level has a greater setback.

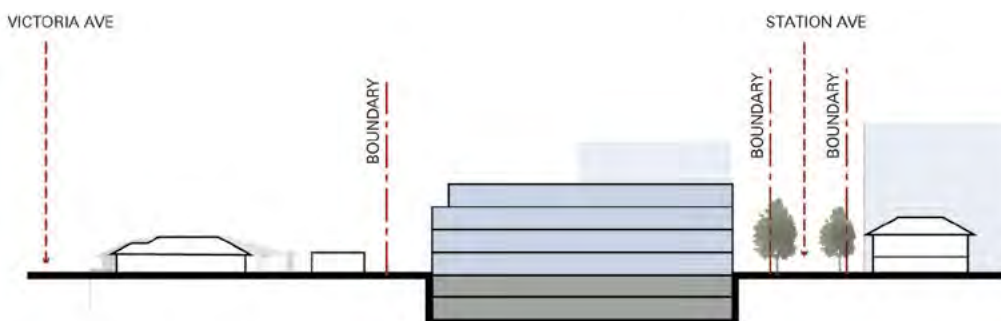

Figure K6-9 Section D-D



### Example Built Form Sections

#### Sub-Precinct 3

#### King Street Interface

Section E-E below illustrates the building mass for the site immediately north of the future urban plaza. The northern boundary has a 3 metre setback and requires a two storey interface height with 10 metres of the northern boundary. Ground level active uses are to be provided at Station Square.

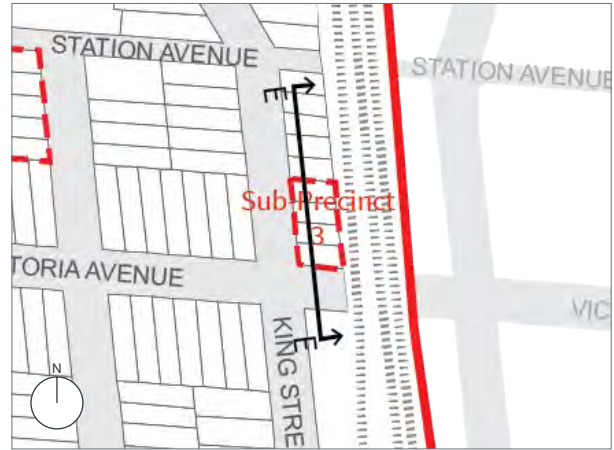

Figure K6-10 Key Plan Sub-Precinct 3

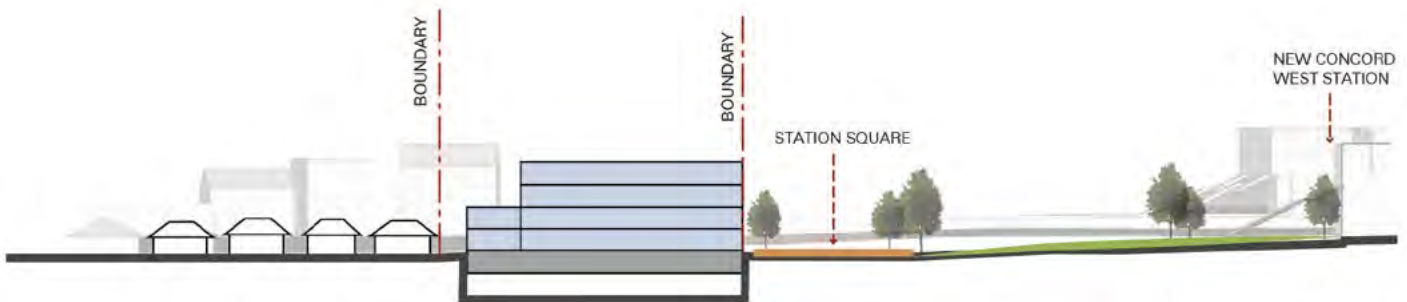

Figure K6-11 Section E-E

### Example Built Form Sections

#### Sub-Precinct 5

#### George Street Interface

Section F-F below illustrates the stepping down of building heights from 6 storeys to 4 storeys at the northern interface to low scale residential.

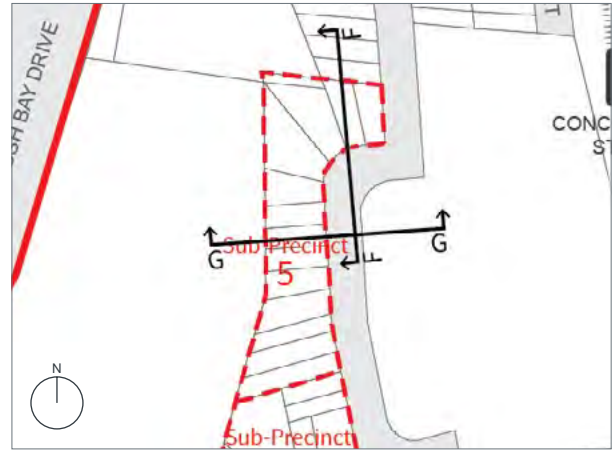

Figure K6-12 Key Plan Sub-Precinct 5

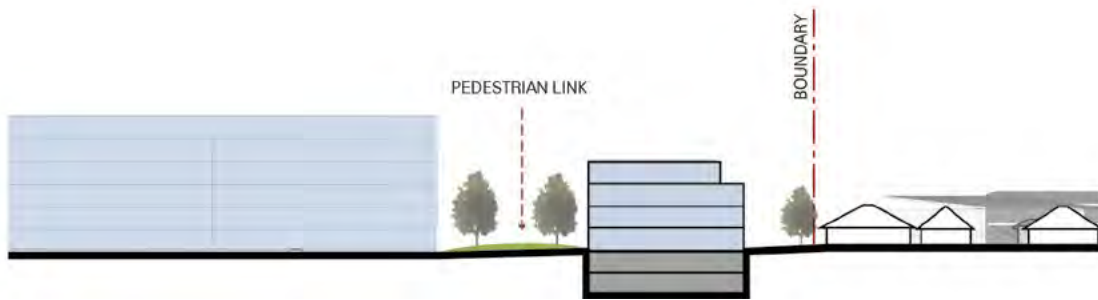

Figure K6-13 Section F-F

#### George Street Interface

Section GG depicts built form to George Street and upper level setbacks.

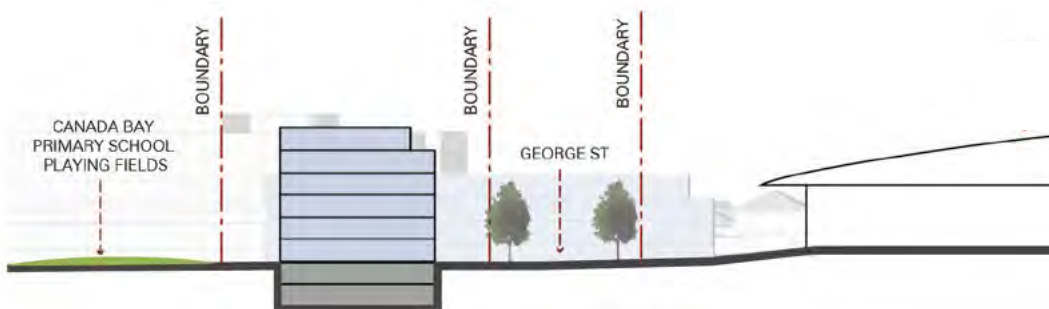

Figure K6-14 Section G-G

### Example Built Form Sections

#### Sub-Precinct 6

#### Rothwell Street Interface

Section H-H below illustrates 4 storey built form to adjacent low scale residential.



Figure K6-15 Key Plan Sub-Precinct 6

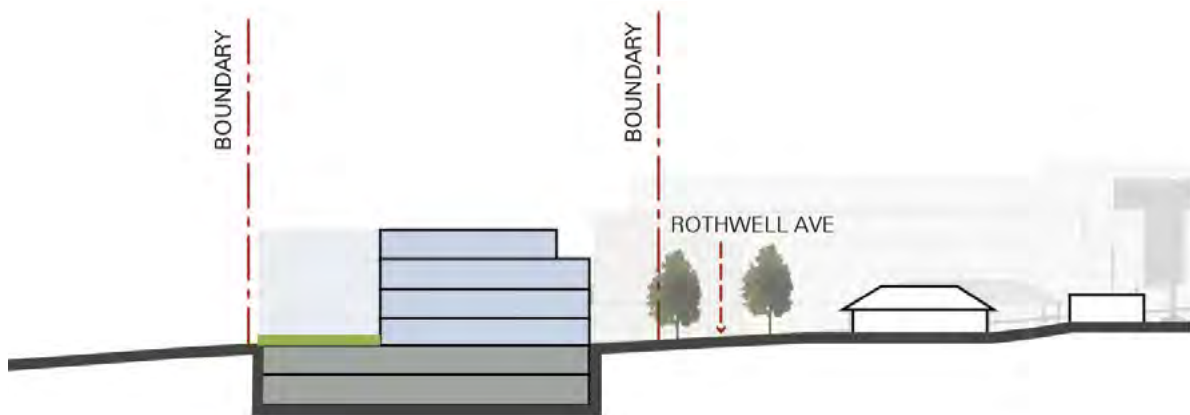

Figure K6-16 Section H-H

### Example Built Form Sections

#### Sub-Precinct 7

#### George Street Interface

Section I-I below illustrates a 4 storey building height to George Street maintaining the existing street wall character of the neighbouring properties.

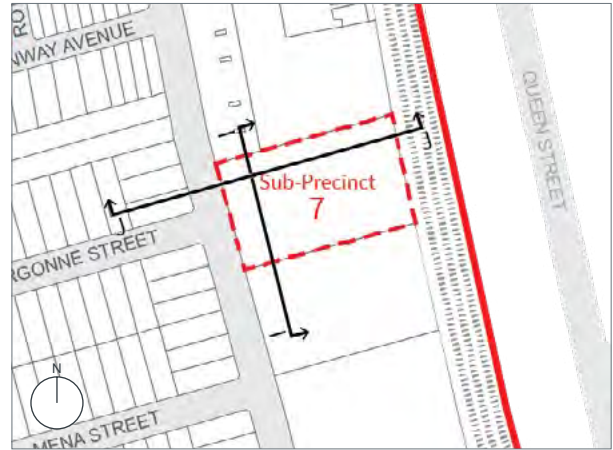

Figure K6-19 Key Plan Sub-Precinct 7

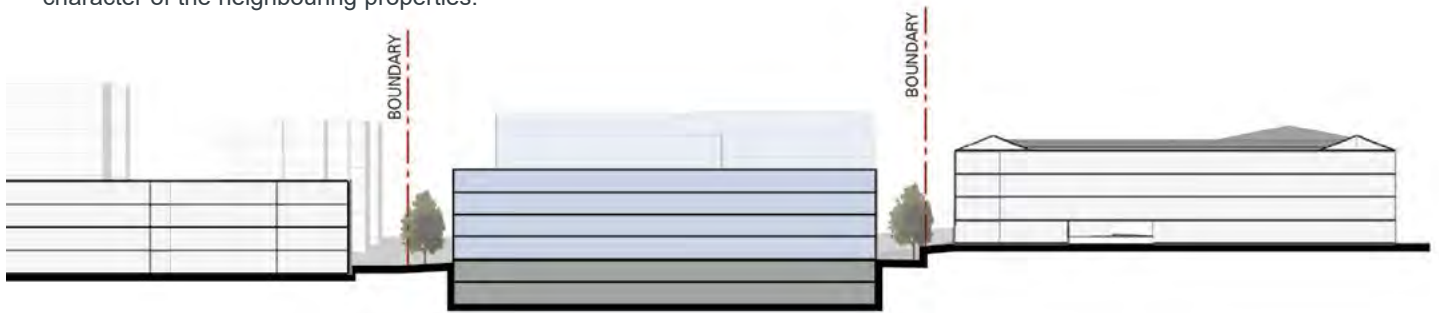

Figure K6-17 Section I-I

#### George Street Interface

Section J-J shows the transition in height from George Street to the rear of the site and in conjunction with neighbouring properties to the north and south.

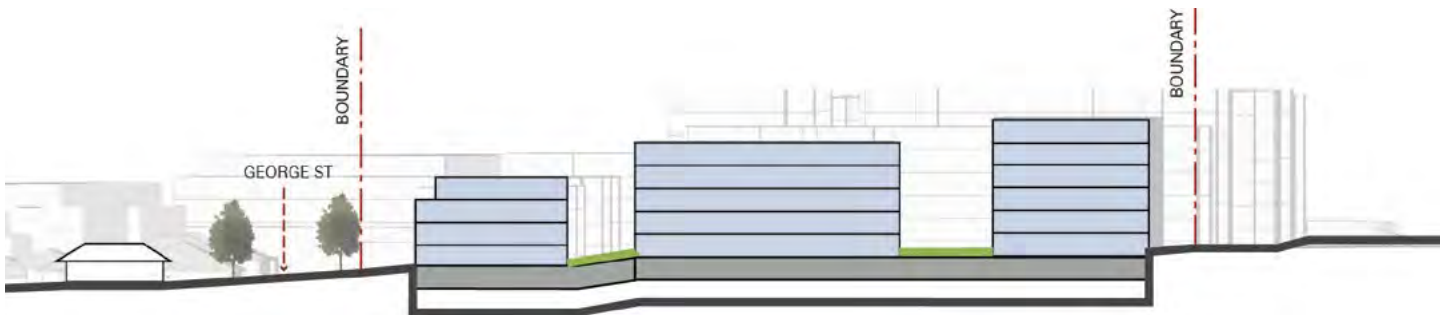

Figure K6-18 Section J-J

### K7 Edgewood and Kendall Inlet (former Dulux site)



Figure K7-1 Aerial photo (source: nearmap.com)

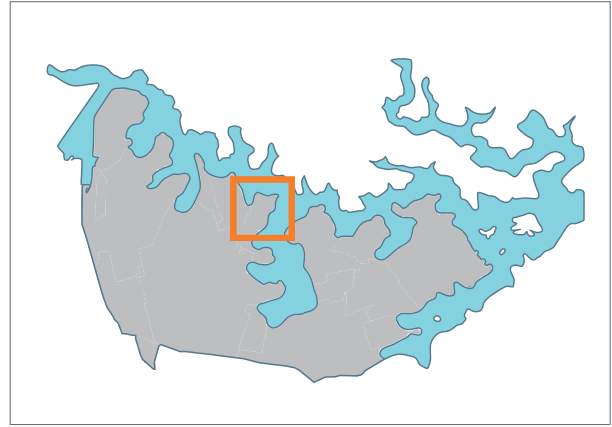

Figure K7-2 Council area map



Figure K7-3 Edgewood and Kendall Inlet - Location Plan



## K7.1 General objectives

- O1 Provide a pleasant, functional and safe environment to and along the foreshore for cyclists and pedestrians;
- O2 Maintain significant views and vistas into and out of the site;
- O3 Protect the heritage buildings, Correys House and Strathroy, and their setting on the site;
- O4 Ensure adequate provision of landscaping and useable private and public open space;
- O5 Provide for pedestrian and cycle linkages through the site to adjoining areas;
- O6 Provide adequate carparking and bicycle storage facilities on the site;
- O7 Maximise visual and acoustic privacy to adjoining properties and within the development itself;
- O8 Ensure adequate daylight and sunlight are maintained to existing development, new development and open spaces;
- O9 Ensure the existing streetscape character is maintained and enhanced;
- O10 Ensure development and access networks are integrated with the existing built and natural environment;
- O11 Ensure development presents an appropriate bulk and scale to public areas having regard to existing development and the topography of the site; and
- O12 Ensure the design orientation of buildings and materials used in construction utilise renewable resources.

## K7.2 Specific provisions

### Streetscape

- O13 To integrate new development in a manner which complements the character of the area and relates to the pedestrian environment.

### Controls

|     |  |
|-----|--|
| C1. | Buildings are to be setback 9 metres from the Cabarita Road frontage.  |
| C2. | Buildings facades are to be oriented towards existing public street frontages.   |
| C3. | Buildings are not to exceed two storeys in height on the Cabarita Road frontage.   |
| C4. | Building length on Cabarita Road is not to exceed 20 metres to give the appearance of separate buildings and provide views into the site.  |
| C5. | Fences having frontage to public open space or public roadway are: <ul style="list-style-type: none"> <li>• not to exceed 1 metre in height if of solid construction; and</li> <li>• not to exceed 1.5 metres if of 'open' type design.</li> </ul> |
| C6. | Continuous fencing for more than 20 metres (average frontage of existing development) should have some visual or physical relief.  |
| C7. | Seating areas in a landscaped setting are to be provided every 100 metres along the frontage.  |

### Side Boundaries

O14 To minimise the impact of new development on adjoining areas.

| Controls |  |
|----------|--|
| C8.      | Buildings must comply with the building height plane. (see definitions)                            |
| C9.      | Wall openings should be provided at a minimum of 3 metre separation.                               |
| C10.     | Fences on the southern boundary will need to comply with the Dividing Fences Act.                  |
| C11.     | Fences adjoining Cabarita Park should not exceed 1.8 metres in height and be of 'open' appearance. |

### Foreshore Frontage

O15 To ensure the integrity of the foreshore is maintained and enhanced for public enjoyment.

| Controls |  |
|----------|--|
| C12.     | Building height plane to apply from the property boundary. An average setback of 13.5 metres, having a minimum width of 9 metres, is to be provided from the high water mark to the development for public foreshore access.   |
| C13.     | Buildings are to be setback a minimum of four metres from the public foreshore accessway. The location of buildings should not result in overshadowing to the foreshore between the hours of 9am - 3pm (EST) 10am - 4 pm (Daylight saving time).   |
| C14.     | The foreshore access is to be in a landscaped setting and comprise: <ul style="list-style-type: none"> <li>• a pedestrian pathway with minimum dimensions of 1.0 metre; and</li> <li>• a cycleway with minimum dimensions of 0.8 metres with a separation distance of 0.7 metres.</li> </ul> |

### Height of Building

O16 To ensure the building envelope relates to the topography of the site, providing an appropriate bulk and scale having regard to the foreshore location, streetscape and adjoining properties.

| Controls |   |
|----------|---|
| C15.     | Buildings should not exceed the building height plane on all boundaries and development should be no higher than: <ul style="list-style-type: none"> <li>• 11 metres from existing ground level to the ridge lines of the building as measured from Cabarita Road.</li> </ul> |

### Bulk and Scale

O17 To ensure the location, layout and design of buildings has regard to the impact of development on views from surrounding public spaces and within the development.

| Controls |   |
|----------|---|
| C16.     | Buildings comply with the building height plane, floor space ratio, landscaping and tree lining of Cabarita Road. |

### Building Design

O18 To ensure a high quality design which is integrated into the existing environment.

| Controls |   |
|----------|---|
| C17.     | All buildings are to have pitched roof forms.       |
| C18.     | Access driveways are to provide a landscaped entry. |

### Visual and Acoustic privacy

O19 To provide visual and acoustic privacy to adjoining properties and within the development itself.

| Controls |   |
|----------|---|
| C19.     | <p>The minimum separation distance between directly overlooking dwelling units is:</p> <ul style="list-style-type: none"> <li>• 6m between non-habitable rooms; and</li> <li>• 9m between habitable and non-habitable rooms; and</li> <li>• 12m between habitable rooms.</li> </ul>   |
| C20.     | <p>Where there are direct views between living areas or into adjoining private open space, fixed windows should be obscured or windows offset or screened appropriately.</p> <p>Balconies are to adhere to the following setbacks:</p> <ul style="list-style-type: none"> <li>• 6m from walls without balconies or windows; and</li> <li>• 12 metres from walls with balconies or windows.</li> </ul> |
| C21.     | <p>Bedrooms of one dwelling do not share walls with living rooms or garages of adjacent dwellings.</p> <p>Bedroom windows are at least 3m from shared streets, driveways and parking areas of other dwellings.</p> <p>Shared walls and floors between dwellings are constructed in accordance with the noise transmission and insulation requirements of the Building Code of Australia.</p>          |

### Views

O20 To maintain views through the site from public spaces.

| Controls |   |
|----------|---|
| C22.     | A view corridor is to be maintained from Cabarita Road, through the development to the foreshore on both sites. |

### Open Space Provision

O21 To provide quality open space for the enjoyment of users.

| Controls |  |
|----------|--|
| C23.     | A landscaped area of 45% of the site area. |

### Private Open Space

O22 To ensure adequate usable private open space to meet the needs of residents.

| Controls |   |
|----------|---|
| C24.     | <p>For above ground development, the open space may take the form of a balcony directly connected to the dwelling with the following minimum requirements:</p> <ul style="list-style-type: none"> <li>• 1 bdr - minimum area of 6m<sup>2</sup> having a minimum dimension of 2m;</li> <li>• 2 bdr - minimum area of 8m<sup>2</sup> having a minimum dimension of 2m; and</li> <li>• 3 bdr or greater - minimum area of 12m<sup>2</sup> having a minimum dimension of 2m.</li> </ul> |
| C25.     | <p>For development at ground level the following minimum requirements apply:</p> <ul style="list-style-type: none"> <li>• 1 bdr - minimum area of 10m<sup>2</sup> having a minimum dimension of 3m;</li> <li>• 2 bdr - minimum area of 16m<sup>2</sup> having a minimum dimension of 4m; and</li> <li>• 3 bdr or greater - minimum area of 35m<sup>2</sup> having a minimum dimension of 4m.</li> </ul>   |



## Location of Parking

### Controls

|      |  |
|------|--|
| C26. | Parking is not permitted between the building and street alignment.                                      |
| C27. | Parking shall be in the form of a garage, basement car park, covered carport or an equivalent open area. |

## Vehicular Access

### Controls

|      |   |
|------|---|
| C28. | Security gates are not to be installed at entry and exit points into the development from Cabarita Road.<br><br>Vehicular access into the development is to be directly from Cabarita Road, with the exception of service vehicles to access Strathroy. |
|------|---|

## Protection of Heritage Buildings and Context

O23 To protect and enhance heritage buildings on the site and in their context.

### Controls

|      |   |
|------|---|
| C29. | No development is to be within the Cabarita Road frontage and Correy's House. In addition, a minimum curtilage of 10 metres is to be maintained around Correy's House.<br><br>No development is to be located between the Parramatta River and Strathroy House. In addition, a minimum curtilage of 10 metres is to be maintained around Strathroy House. |
| C30. | The curtilage of the heritage buildings is to be landscaped, using species appropriate to the heritage context.   |

## Use of Heritage Items

O24 To ensure the use of buildings will not impact on the heritage significance or detract from residential amenity.

### Controls

|      |  |
|------|--|
| C31. | Where a public or community use is proposed, the hours of operation will be dependent upon: <ul style="list-style-type: none"> <li>• the nature of use proposed;</li> <li>• the proximity to residences; and</li> <li>• the likely noise generated.</li> </ul> A Heritage Management Plan is to be prepared which includes: <ul style="list-style-type: none"> <li>• uses proposed for Correy's House and Strathroy House;</li> <li>• landscaping</li> <li>• means of access;</li> <li>• hours of operation;</li> <li>• maintenance program; and</li> <li>• management program.</li> </ul> |
|------|--|

## K8 27 George Street North Strathfield



Figure K8-1 Aerial photo (source: nearmap.com)

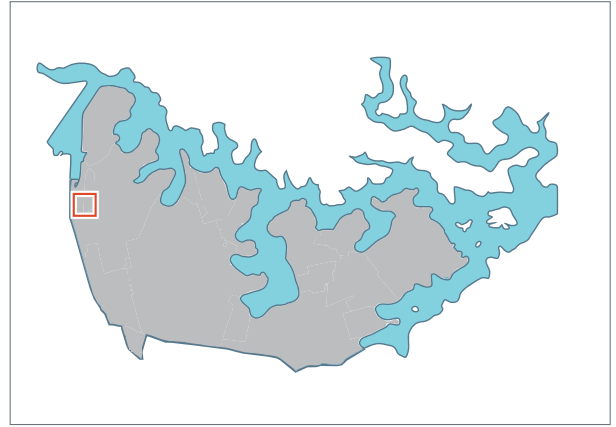

Figure K8-2 Council area map



Figure K8-3 27 George Street, North Strathfield - Location Plan



## K8.1 General objectives

- O1. To encourage and facilitate development on the site which, in terms of scale, bulk, form and character reflects the physical context of the site and is sympathetic to surrounding residential development;
- O2. To minimise the impact of the development in terms of overlooking and loss of sunlight from adjoining and neighbouring properties;
- O3. To provide for the active and passive recreation needs of residents of the development and incorporate recreation facilities such as a swimming pool and tennis courts; and
- O4. To provide for safe access to and from the site.

## K8.2 Specific provisions

### Density, Design, Scale and Bulk

#### Objective

- O5. To achieve a development outcome which, in terms of its density, design, scale and bulk, responds in a sympathetic and harmonious manner to the site and surrounding residential development.

#### Controls

|     |   |
|-----|---|
| C1. | A minimum of 10% of the gross floor area of the site must be used for commercial development.                     |
| C2. | A minimum of 10% of the residential floor space must be developed for older persons and people with a disability. |

#### Height

#### Controls

|     |   |
|-----|---|
| C3. | Buildings shall be a maximum of four (4) storeys. |
|-----|---|

## Setbacks and Building Lines

#### Controls

|     |  |
|-----|--|
| C4. | The following building lines are imposed: <ul style="list-style-type: none"> <li>• Six metres to George Street and the eastern boundary with the rail corridor; and</li> <li>• Five metres to the northern, eastern and southern side boundaries.</li> </ul> |
|-----|--|

## Design and Form

#### Controls

|     |   |
|-----|---|
| C5. | Buildings are to be articulated and are not to present long, unrelieved structures that dominate the landscape. |
|-----|---|

## Site Coverage

#### Controls

|     |   |
|-----|---|
| C6. | The total site cover of all buildings within the development shall be equal to or less than 40% of the total site area. |
|-----|---|

## Dwelling Amenity

#### Controls

|     |   |
|-----|---|
| C7. | Dwellings should be designed and orientated to take advantage of views, solar access and proximity to open space areas.   |
| C8. | Consideration should be given to the efficiency of interior layout, room size, security and safety, opportunities for cross breezes, energy efficiency, conservation and privacy. |
| C9. | At least 50% of the area of communal open space should have a minimum 3 hours of solar access between 9am and 3pm at the Winter Solstice (21 June).                               |

|      |   |
|------|---|
| C10. | Shadow diagrams for the hours of 10am, 12 noon and 2pm for 21 June will be required to accompany any development application for the site.  |
| C11. | All units should be provided with clothes drying facilities and adequate storage capacity.  |
| C12. | Openings (windows and doors) from living areas must not be located directly opposite neighbouring windows or openings where it is likely to result in unreasonable noise problems between buildings.  |
| C13. | Buildings shall be designed and located to take account of rail related noise and vibration from the Main Northern Rail Line in accordance with standards as set out in the Environmental Protection Authority (EPA) 'Environmental Noise Control Manual' 1994, Australian Standard 2670 Part 1 'evaluation of Human exposure to Vibration and Shock in Buildings (1 to 80Hz)' and any rail policy endorsed by the EPA or any noise and vibration publications by State Rail and Rail Infrastructure Corporation. |
| C14. | In designing the layout, arrangement etc. of buildings, regard shall be made to possible existing noise sources and especially the adjacent industrial premises so as to minimise the impact of noise on future residents, eliminate the likelihood of any reflection or reverberation adversely affecting existing residential properties.   |
| C15. | All units should be provided with energy efficient clothes drying facilities, either: <ul style="list-style-type: none"> <li>• in cross ventilated drying cupboards or other drying provisions on balconies;</li> <li>• in private open spaces; or</li> <li>• dryers with 4 NATHERS rating.</li> </ul>  |

## Landscaped Open Spaces

### Objective

- O6. To ensure the provision of open space and landscaped areas for the amenity of residents.

### Controls

|      |  |
|------|--|
| C16. | To ensure adequate provision of open space, maximum permissible site coverage is 40%.  |
| C17. | Landscaped open spaces should be provided to accommodate a range of communal and individual needs. There should be a primary open space area containing a recreation facility such as a pool/spa or similar, and this facility be easily accessible to all residents on site. Smaller, more intimate landscaped areas should be provided throughout the site and be accessible via a pathway system. |
| C18. | Landscaped areas should generally be dominated by vegetation and not masonry elements with areas capable of supporting deep soil planting. Hard paved areas should, where possible, be kept to a minimum in order to reduce stormwater runoff, although wheelchair access and remediation requirements must be considered.   |

## Public and Private Open Spaces

### Controls

|      |  |
|------|--|
| C19. | Useable communal and open space is to be provided at a rate of 40m <sup>2</sup> per dwelling. Driveways, pathways and parking areas are excluded from the open space calculations.   |
| C20. | A minimum area of 20m <sup>2</sup> of private open space with a minimum dimension of 4m is to be provided for ground floor units and accessible from the main living areas. A minimum area of 10m <sup>2</sup> of private open space with a minimum dimension of 2m is to be provided for all above ground units, accessible from the main living areas. |

## Car Parking and Access

### Objective

- O7. Adequate provisions should be made for on-site resident parking and visitor parking without causing any detrimental impact on the amenity of the development, streetscape and neighbourhood.

#### Controls

|      |  |
|------|--|
| C21. | The provision of at least one (1) loading dock for each residential building is desirable.                         |
| C22. | Loading docks are to be provided for the commercial areas.   |
| C23. | Access to the site is not to be provided by a 'gatehouse' security system, which limits public access to the site. |

## Pedestrian Access

#### Controls

|      |   |
|------|---|
| C24. | Safe pedestrian access is to be maintained throughout the site. |
|------|---|

## Impact on Adjoining Properties

### Objective

- O8. To provide attractive streetscapes which enhance the amenity of neighbouring development.

## Streetscape

#### Controls

|      |  |
|------|--|
| C25. | The setback of buildings from the street frontages to be appropriate to the streetscape character. |
|------|--|

# K9 186 Great North Road, Five Dock



Figure K9-1 Aerial photo (source: nearmap.com)

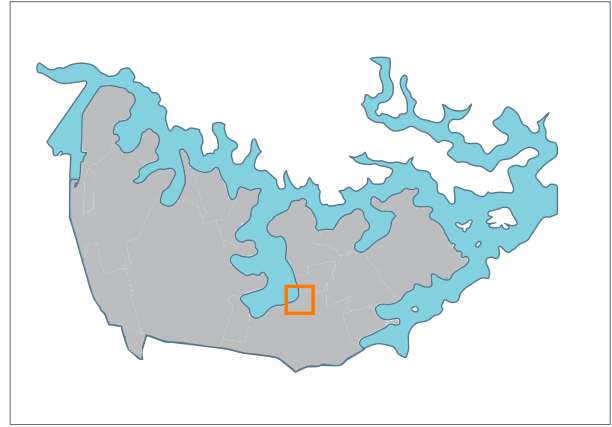

Figure K9-2 Council area map



Figure K9-3 186 Great North Road, Five Dock - Location Plan



The following objectives and controls have been prepared to ensure that the land at 186 Great North Road, Five Dock accommodates a high quality development.

### K9.20 Objectives and provisions

- O1. Future development has adequate building setbacks and separation so that buildings are seen within a landscaped setting;
- O2. Provide lower building heights on the McKinnon Avenue and Great North Road frontages to provide an appropriate bulk/scale relationship with the surrounding locality;
- O3. To protect important built and natural elements both in the private and public domain; and
- O4. Ensure the use of high quality facade and design finishes.

#### Controls

|     |   |
|-----|---|
| C1. | The maximum number of storeys permitted on the site is shown in Figure K9-4 Maximum Heights, Figure K9-9 Cross Section A, Figure K9-11 Cross Section B and Figure K9-13 Cross Section C.  |
| C2. | The minimum setbacks from boundaries are shown in Figure K9-5 Setbacks.   |
| C3. | A minimum of 38% of the site is to comprise landscaped area. (Landscaped area means any part of the site used for growing plants, grasses and trees but does not include any building, structure or hard paved area).   |
| C4. | A minimum of 28% of the site area is to comprise deep soil landscaping. (Deep soil area means any part of the total landscaped area that does not include buildings or other structures under - with the exception of measures for the remediation of contaminated land). |

|      |  |
|------|--|
| C5.  | The Fig trees on Lyons Road are to be protected throughout construction and following completion of building through setbacks of the building and associated basements.        |
| C6.  | Vehicle Access from Great North Road and Lyons Road is not permitted. Vehicular access to and from the site must be from McKinnon Avenue. Refer to Figure K9-7 Vehicle Access. |
| C7.  | The Tobruk Memorial is to be retained on the corner of Great North Road and Lyons Road.  |
| C8.  | In addition to the 8.0m from the southern boundary adjacent to Lyons Road, all buildings are to be set back an additional 1.5m from the canopy of the Fig trees.               |
| C9.  | Buildings are to be designed to face the street, and to enhance the public domain through entrances, good quality finishes and well resolved architectural design.             |
| C10. | Fencing on the site is to be designed so that sight lines for both pedestrian and vehicles are not obscured.   |
| C11. | Roof forms, plant and lift overruns are to be designed to be simple compact forms that are visually unobtrusive.   |



Figure K9-4 Maximum Heights



Figure K9-5 Setbacks





Figure K9-6 Landscaping



Figure K9-7 Vehicle Access

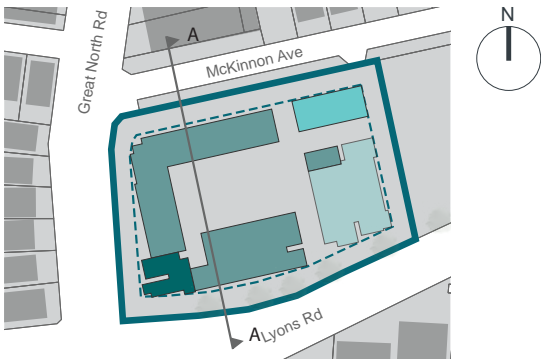

Figure K9-8 Key plan

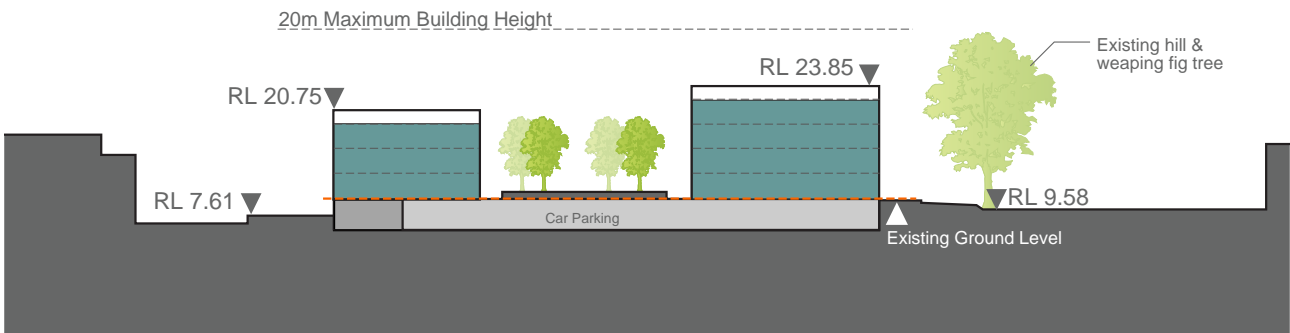

Figure K9-9 Cross Section A

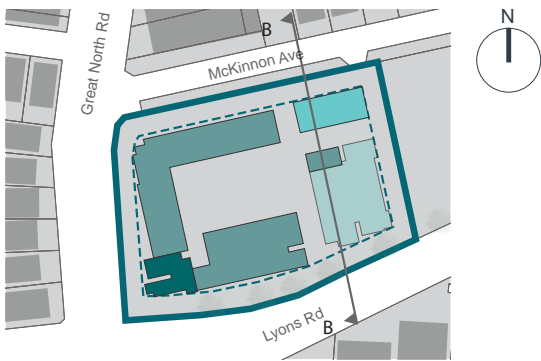

Figure K9-10 Key plan

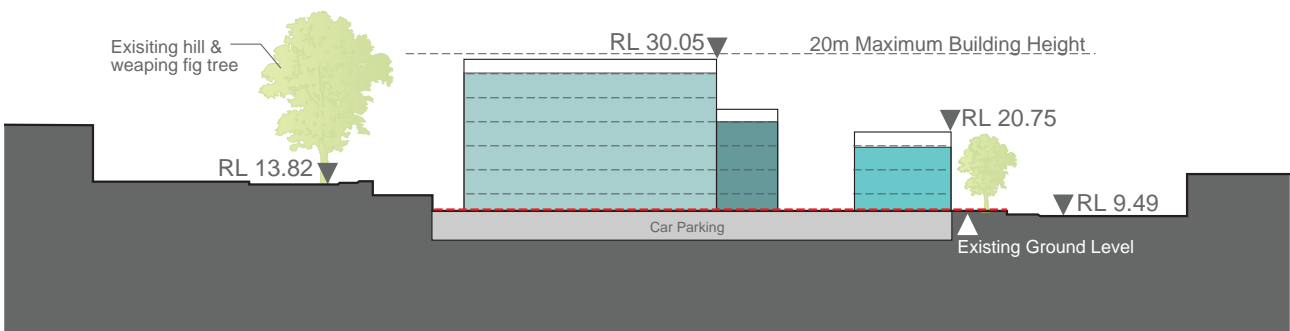

Figure K9-11 Cross Section B

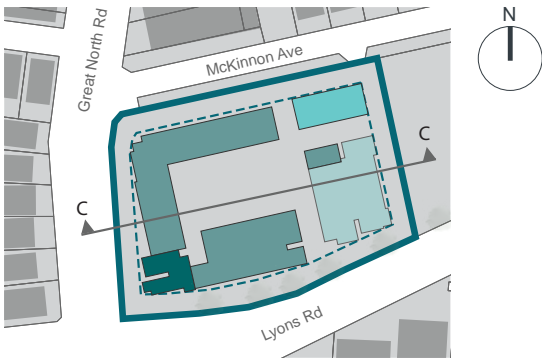

Figure K9-12 Key plan

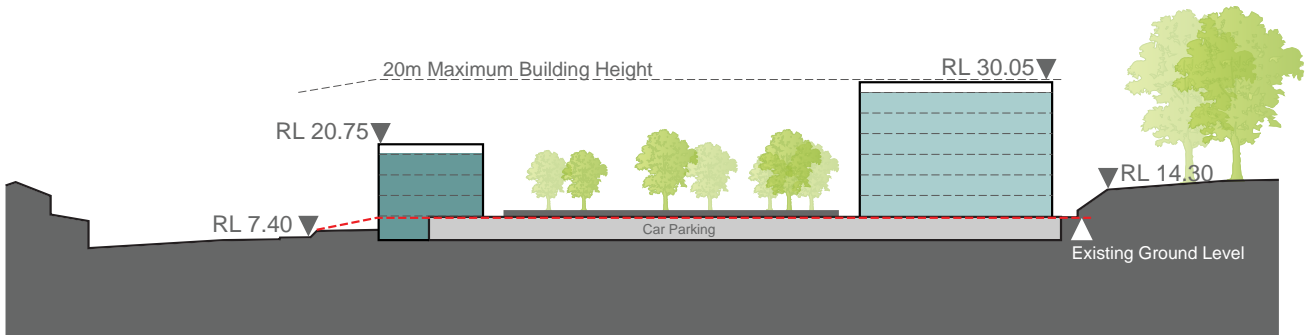

Figure K9-13 Cross Section C

# K10 2A Hythe Street, Drummoyne



Figure K10-1 Aerial photo (source: nearmap.com)

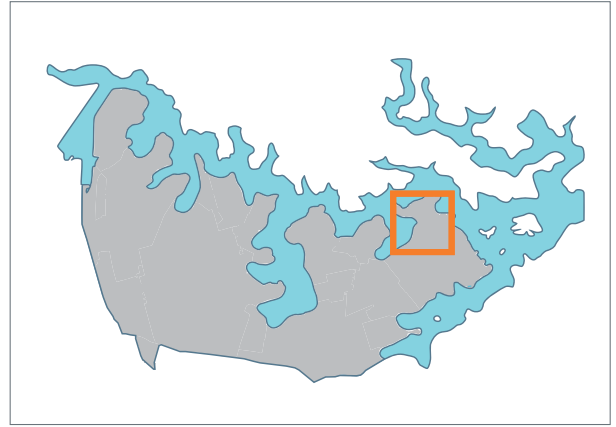

Figure K10-2 Council area map



Figure K10-3 2A Hythe Street - Location Plan



## K10.1 General objectives

- O1 To achieve a coordinated urban design outcome.
- O2 To enhance the existing streetscape and ensure appropriate development scale and interface near residential areas.
- O3 To minimise solar access and privacy impacts upon surrounding properties.
- O4 To minimise the impact of any excavation on adjoining buildings and existing landscape.
- O5 The design of balconies is not to significantly increase the visual bulk of the building.

| Controls |  |
|----------|--|
| C1.      | Buildings are to adhere to the following setbacks: 6m to the south-western property boundary; 6m to the western boundary; 8m to the north-western property boundary. |
| C2.      | The maximum building height is RL 19.9 on the corner of Westbourne Street and Hythe Street. The maximum building height on the remainder of the site is 8.5 metres.  |
| C3.      | Water Sensitive Urban Design systems are to be implemented and detailed in landscape plans and stormwater solutions on the site.                                     |
| C4.      | No excavation is to occur within the "Nil excavation zone".  |
| C5.      | Balconies within the balcony zone are to have a light weight design character, for example a glass or metal balustrade   |
| C6.      | Preclude vehicular access and egress from Westbourne Street and Hinkler Court.   |



Figure K10-4 Consolidated development controls plan

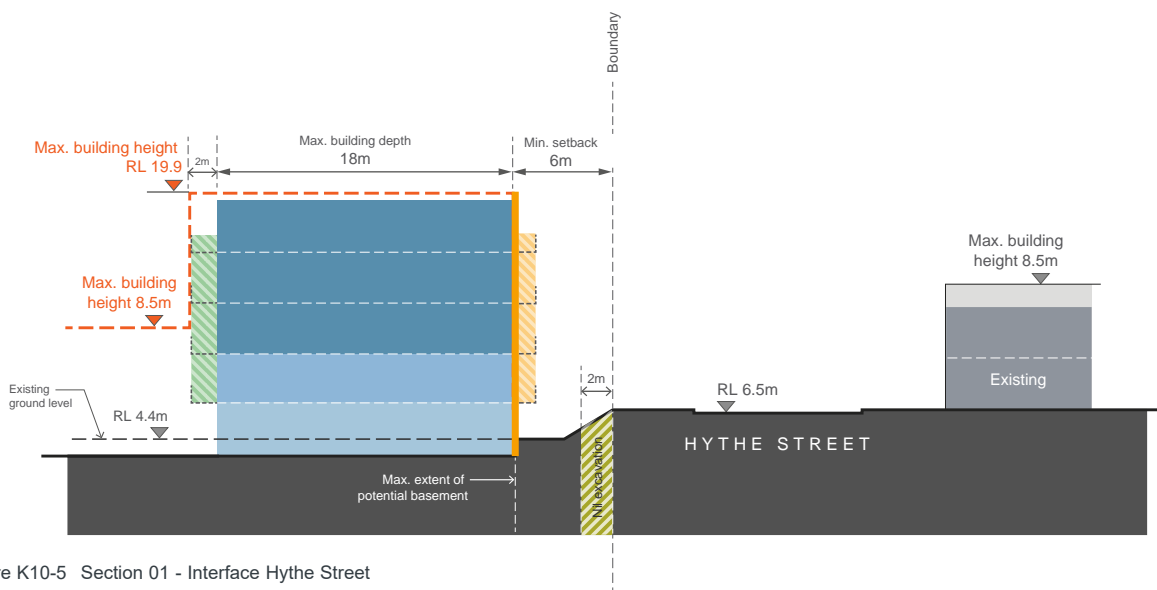

Figure K10-5 Section 01 - Interface Hythe Street

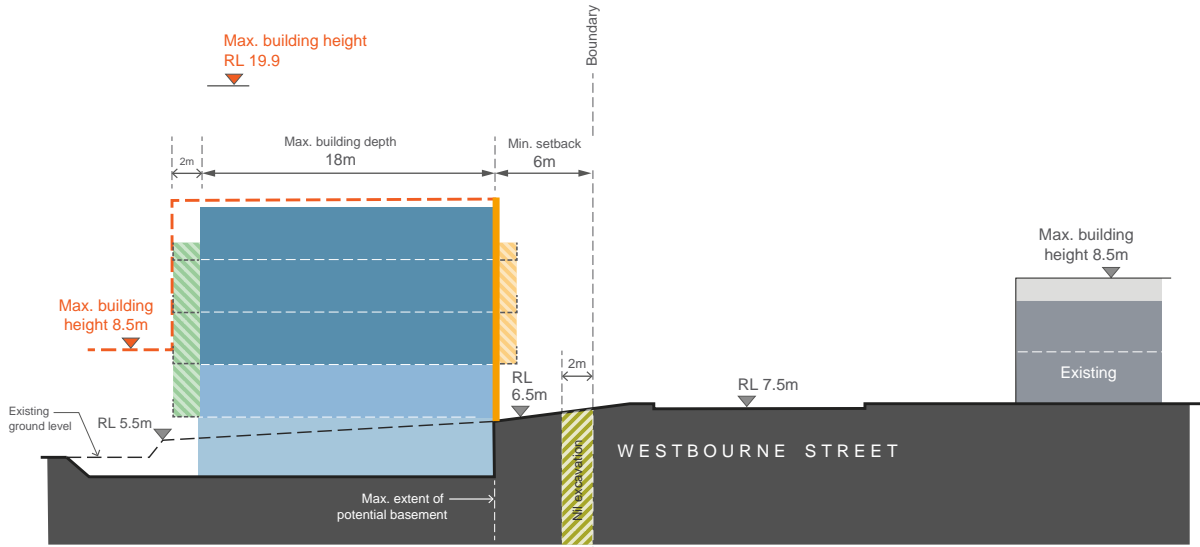

Figure K10-6 Section 02 - Interface Westbourne Street

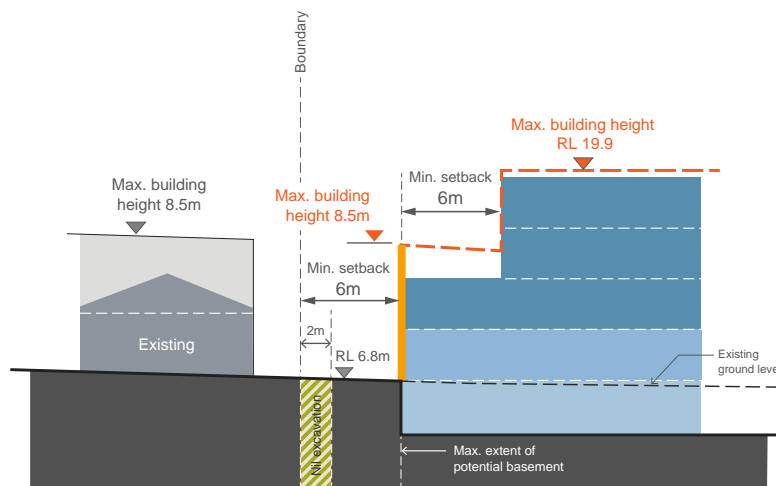

Figure K10-7 Section 03 - Interface South-Western Boundary

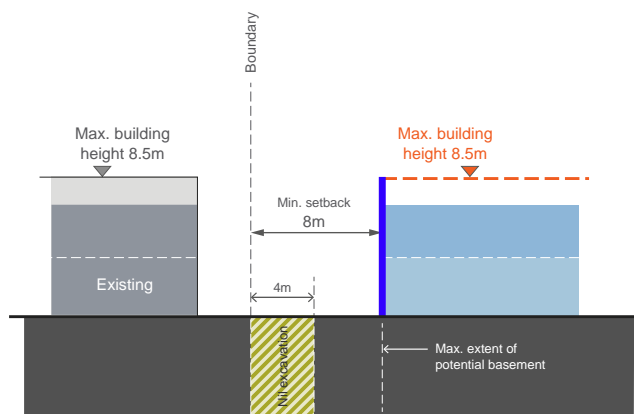

Figure K10-8 Section 04 - Interface North-Western Boundary

# K11 Kings Bay (former Hycraft site), Five Dock



Figure K11-1 Aerial photo (source: nearmap.com)

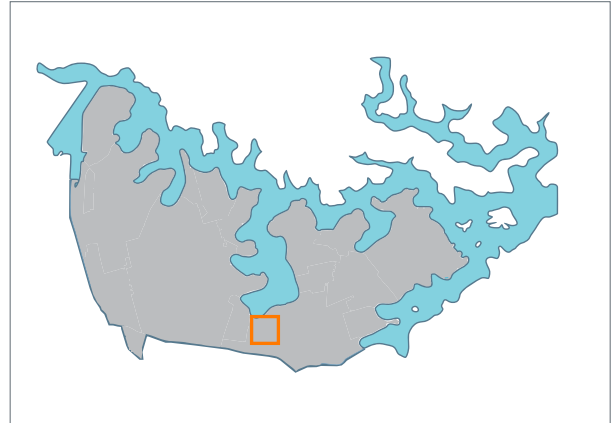

Figure K11-2 Council area map



Figure K11-3 Kings Bay (former Hycraft site), Five Dock - Location Plan





### K11.1 General objectives

- O1. To create a new form of housing in this area which in terms of scale, bulk and form respects the existing pattern of the public domain and mediates between the built form of the area and earlier inner city suburbs;
- O2. To facilitate development of the site which responds to the context of the site by locating larger scale development adjacent to open space areas or non residential uses;
- O3. To minimise the impact of the new development on the site on privacy and sunlight access of neighbouring residential properties;
- O4. To provide for the recreation needs of the new residents of the site;
- O5. To identify and retain any significant trees on the site; and
- O6. To provide safe access to and from the site for cars and pedestrians.

### K11.2 Specific provisions

#### Density, Design, Height, Scale and Bulk

##### Objectives

- O7. To achieve development of the site which will introduce new housing forms to this area in a way which respects the traditional urban environment; and
- O8. To ensure that the bulk and scale of the new development is sympathetic to the existing development in the area.

### Height

| Controls |   |
|----------|---|
| C1.      | Subject to the maximum height of buildings, is to comply with the heights for the various sections of the site as shown in Figure K11-4 Maximum height of buildings.                          |
| C2.      | Notwithstanding the above, the roofspace of buildings west of the central park as shown hatched on the height plan (see Figure K11-4 Maximum height of buildings) can be used as floor space. |

### Site coverage

| Controls |   |
|----------|---|
| C3.      | Building footprints must not occupy more than 30% of the total site area. |

### Setbacks

| Controls |  |
|----------|--|
| C4.      | The wall to the below grade parking structure is to be set back a minimum of 3.5m from the boundary of William Street.   |
| C5.      | Buildings are to be set back a minimum of 6m from the boundary of William Street at ground level.  |
| C6.      | Buildings are to be set back a minimum of 5m from the boundary of Harris Road at ground level.   |
| C7.      | Buildings are to be set back a minimum of 7.5m from the rear property boundaries in Kings Road at ground level.  |
| C8.      | For the 5 & 6 storey building heights shown on Figure K11-4 Maximum height of buildings the top floor of each will be set back a further 2.5m from the floor below along William Street. |
| C9.      | Houses at the eastern side of the central park are to be setback a minimum of 4.5m from lot boundary.  |

## Design and Built Form

| Controls |   |
|----------|---|
| C10.     | The site is to be developed as part of a comprehensive scheme where there is a strong relationship in design terms between the various elements of the development.   |
| C11.     | There is to be a variety of medium density development on the site ranging from terrace houses to residential flat buildings located around a central open space area (see Figure K11-4 Maximum height of buildings).   |
| C12.     | Higher density development should be located at the western end of the site where its apparent height and bulk can be related to open space and non residential uses or serviced apartments on neighbouring boundaries. |
| C13.     | Where appropriate, buildings should formally present to the existing street frontages and integrate with existing streetscapes.   |
| C14.     | Roof forms should be predominantly pitched especially on the lower density development on the site.   |
| C15.     | The orientation of development should capitalise on solar access and views, and buildings should be located in relation to roads and open space to create a strong sense of place.                                      |

## Open Space

### Objectives

- O9. To provide open space which will form a physical focus for the development;
- O10. To meet the requirements of the residents of the site in relation to formal and informal recreation activities. These requirements are to be assessed on the basis of the likely future population of the site; and
- O11. Design and integrate landscaping into the development both as part of the open space areas and other areas of the public domain.

## Location and Design

| Controls |   |
|----------|---|
| C16.     | Figure K11-4 Maximum height of buildings shows the location for the major open space areas on the site. Other smaller areas may be provided on the site for informal activities. A standard of 2.51ha per 1,000 residents of dedicated public open space has been adopted by Council. A minimum of 5,000m <sup>2</sup> is to be provided on site. |
| C17.     | Where possible there should be pedestrian linkages between the open space areas.  |
| C18.     | Landscaped open space areas should provide for a range of recreation needs covering both formal and informal activities.  |

## Private Open Space

| Controls |  |
|----------|--|
| C19.     | At least 40m <sup>2</sup> per dwelling of landscaped private open space is to be provided on the site. This does not need to adjoin each dwelling but can be provided in larger areas.                   |
| C20.     | Each dwelling must have an area of open space attached to it. This may be by way of a balcony or roof terrace, or at ground level. This open space area should have a minimum area of 10m <sup>2</sup> . |



- 6 storey maximum
- 5 storey maximum
- 4 storey maximum
- 3 storey maximum
- 2 storey maximum
- Open space
- Roof space can be used as floor space

Height is measured in storeys, e.g. 3 = 3 storeys + pitched roof



Figure K11-4 Maximum height of buildings



- Underground parking
- Access point



Figure K11-5 Access roads & parking

# K12 Liberty Grove



Figure K12-1 Aerial photo (source: nearmap.com)

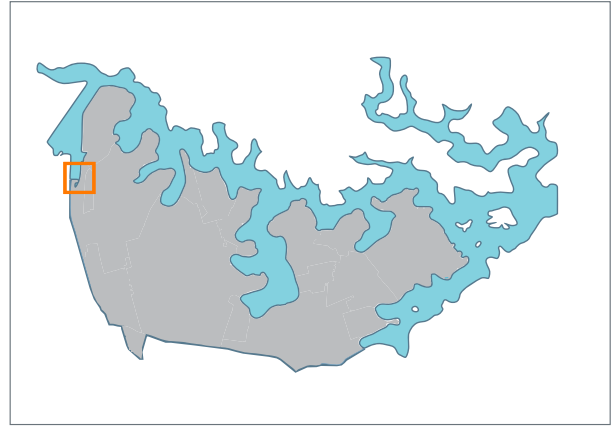

Figure K12-2 Council area map



Figure K12-3 Liberty Grove - Location Plan



## K12.1 General objectives

To provide guidance for the residential development of the land which is attractive to potential and existing residents of Canada Bay, appropriate for the local environment and which takes account of the following:

- O1. Maintenance of the amenity of existing nearby residents of Canada Bay as far as possible with regard to stormwater drainage, landscape quality, privacy, solar access, traffic and noise impacts;
- O2. Maintenance of existing levels and quality of public open space facilities in Canada Bay;
- O3. Integration of the built form with the existing landscape and the locality generally; and
- O4. Public access to achieve integration into the Canada Bay community.

## K12.2 Specific provisions

### Development Density

#### Objective

- O5. To provide a maximum density control that will assist in encouraging a variety of building forms which would be appropriate within the local area by providing for development which takes into account the opportunities and constraints imposed by local infrastructure while providing for an acceptable bulk and scale of development.

| Controls |   |
|----------|---|
| C1.      | The maximum permitted density based on the Gross Site Area shall be 65 dwellings per hectare. "Gross Site Area" means the area of the whole of the land shown edged orange on Figure K12-3 Liberty Grove - Location Plan. |
| C2.      | Where possible there should be pedestrian linkages between the open space areas.  |
| C3.      | Landscaped open space areas should provide for a range of recreation needs covering both formal and informal activities.  |

### Site coverage

#### Controls

- |     |  |
|-----|--|
| C4. | The total site cover of all buildings shall not exceed 35% of the Gross Site Area. This clause applies to all buildings except those provided solely for the following purposes: <ul style="list-style-type: none"> <li>• Public recreation, open space or amenities; and</li> <li>• Garbage storage areas.</li> </ul> |
|-----|--|

### Site requirements

#### Objectives

- O6. To ensure siting of buildings and landscaping to meet reasonable user and neighbour requirements for privacy.
- O7. To provide flexibility in the siting of buildings and minimise adverse impact on adjacent and adjoining properties.
- O8. To achieve a coherent site layout that provides a pleasant, attractive, manageable and resource-efficient living environment.
- O9. To provide adequate space for landscaping, visual and acoustic privacy.

### Setbacks

#### Controls

- |     |   |
|-----|---|
| C5. | The following Building Line setbacks apply: <ul style="list-style-type: none"> <li>• To the Gross Site property boundary - 10m provided however that this may be increased to 15m taking into account the height of any building or structure and its likely impact; and</li> <li>• To any internal road - 4m.</li> </ul> |
| C6. | Generally at least one half of any Building Line Setback shall be comprised solely of soft landscaping.   |

## Traffic and Access

### Objective

- O10. To provide vehicular access that is efficient in layout and provides a safe and pleasant environment for residents and visitors.

#### Controls

- |     |  |
|-----|--|
| C7. | There shall be no vehicular access to or from the site via Concord Avenue or King Street and all access shall be via Homebush Bay Drive and Oulton Avenue. |
|-----|--|

## Open Space

### Objectives

- O11. To provide convenient open space and recreational opportunities for the residents of multi-unit housing projects;
- O12. To enhance the quality of the built environment, and the appearance and character of the site by providing for landscaping;
- O13. To meet the wider community needs for open space and recreation and assist in maintaining the levels of quality and provision of open space;
- O14. To provide for landscaping which takes into account the sensitivity of the adjoining environment of Homebush Bay and minimises the impact of stormwater discharge;
- O15. To provide for passive recreation opportunities; and
- O16. To provide for privacy and shade.

## Landscaping

#### Controls

- |      |   |
|------|---|
| C8.  | All areas not occupied by buildings or roads shall be landscaped predominantly with 'soft' landscaping.   |
| C9.  | Not more than 10% of all landscaping may be used for hard landscaping.  |
| C10. | Paths and paving within landscaped areas should be kept to a minimum and within soft landscaped areas allowed only so as to provide access and for discrete passive recreation opportunities. |
| C11. | Selection and plantings of trees and shrubs should primarily reflect trees and plants of the Parramatta River valley.   |
| C12. | A balance of upper, mid and lower canopy trees is required in all landscaped areas but especially in perimeter setbacks.  |

## General Provisions

### Objective

- O17. To maintain the amenity of existing dwellings near the site and reflect the character of Concord.

## Architectural Design

#### Controls

- |      |   |
|------|---|
| C13. | <p>External design of buildings should have regard to the traditional styles of Concord and especially the California Bungalow theme and especially to the principal features thereof including the following:</p> <ul style="list-style-type: none"> <li>• gable ended pitched roofs;</li> <li>• pilasters and pillars supporting roofs and awnings;</li> <li>• verandahs; and</li> <li>• detailed eaves.</li> </ul> |
|------|---|

# K13 Mortlake Point



Figure K13-1 Aerial photo (source: nearmap.com)

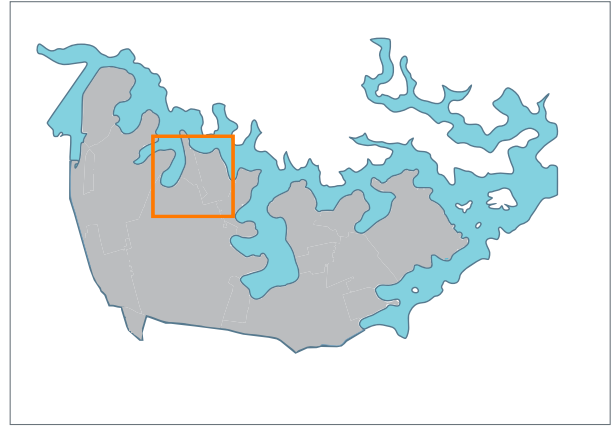

Figure K13-2 Council area map



Figure K13-3 Mortlake Point - Location Plan



### K13.1 General objectives

The objectives of the Land Use Compatibility component of this DCP are outlined below. All development in Mortlake Point is to comply with these Objectives.

- O1 Ensure that all potential amenity impacts of proposed development are mitigated through appropriate design responses;
- O2 Ensure that new residential development provides an acceptable level of amenity where located adjacent to non-residential land uses, through design responses that mitigate any impact from existing non-residential land uses;
- O3 Ensure that residential development would not in any way affect the lawful consent of existing non-residential land uses;
- O4 Ensure that the impact generated by new non-residential development, such as operating hours, noise, privacy, vehicular and pedestrian traffic and other factors is controlled so as to not affect the amenity of adjacent residential development; and
- O5 Ensure that Council is provided with relevant and sufficient information that allows Council to determine the land use compatibility impacts of a proposed development.

### K13.2 Specific provisions

#### General Compatibility Standard for All Development

| Controls |  |
|----------|--|
| C1.      | All development is to utilise a continuous buffer treatment along the interface with adjacent non-compatible land uses. In particular, this should apply to the side and rear boundaries of proposed developments. |
| C2.      | While frontages must be designed so as to not create an unnecessary "solid" frontage that would be unacceptable as streetscape treatment.  |

|     |   |
|-----|---|
| C3. | Development is to use appropriate site layouts that use buildings, walls and other physical aspects to minimise environmental impact on adjacent land uses.   |
| C4. | Adequate provision shall be made for off-street parking on all developments to ensure that no conflicts arise between residential and non-residential developments in the utilisation of on-street parking generally. |

#### Design Requirements for Non-Residential Developments

| Controls |   |
|----------|---|
| C5.      | New non-residential development adjacent to residential development should not generate industrial airborne emissions causing noise, odour, fumes and dust to the extent to which it will affect the amenity of adjacent residential development. |
| C6.      | External walls facing residential properties are to be constructed of materials with good sound insulating quality and no large openings that would transmit noise.   |
| C7.      | Plant equipment and machinery is to be located within the building or screened from adjacent residential uses.  |
| C8.      | Vehicular access must not be provided along the boundary adjacent to residential uses.  |
| C9.      | Loading and maneuvering areas are to be located within the building or screened from adjacent residential uses.   |
| C10.     | The development must be designed so that any traffic generated has a minimal impact on adjacent residential uses and on the local road system.  |
| C11.     | Signage must be of a character that does not detract from the visual amenity of the existing residential uses.  |



|      |  |
|------|--|
| C12. | Lighting systems within the development must not create light spillage onto adjacent residential uses.   |
| C13. | Hours of operation (including waste collection) being limited to between 7am and 6pm, Monday to Friday, with limited hours on Saturday for some uses and no operation on Sunday.         |
| C14. | New non-residential development is to use site layouts that use buildings, walls and other physical elements to provide further protection for noise-sensitive uses from off-site noise. |

### Compatibility Requirements for Residential Development

| Controls |   |
|----------|---|
| C15.     | External walls facing non-residential properties are to be constructed of materials with good sound insulating quality and no large openings (including windows) that would transmit noise.   |
| C16.     | The building plan; walls, windows, doors and roof are to be designed to reduce intrusive noise levels from potential sources of noise emanating from adjacent non-residential uses. Attention should be paid to re-orientating noise sensitive rooms (living, dining, bedrooms) away from potential sources of noise. |
| C17.     | Balconies and other external building elements are to be located, designed and treated to minimise noise infiltration.  |
| C18.     | Where windows are to face non-residential development, they are to be fitted with noise-attenuating glass to minimise the impact of background noise from non-residential development.  |
| C19.     | Landscaping with appropriate setbacks is to be provided on communal and private open space to create a visual buffer between adjacent non-residential development and filter any air-borne particles generated by industry.   |

### Building Height and Scale

#### Objectives

O6 To ensure that new development:

- a) Provides appropriate scale and compatibility with the Mortlake streetscape and the Parramatta River foreshore context;
- b) Ensures reasonable access of all development to significant views, vistas and landmarks within and around Mortlake Point;
- c) Maintains and enhances environmental amenity in the immediate context of the development, including reasonable solar access, adequate levels of privacy and an acceptable level of view sharing; and
- d) Achieve comfortable street environments for pedestrians in terms of daylight, scale, sense of enclosure, as well as providing a healthy environment for street vegetation.

#### Controls

|      |   |
|------|---|
| C20. | Maximum height of new development is not to exceed 12 metres from natural ground level to the uppermost point of the roof structures.   |
| C21. | Building heights are to respond to the topography of Mortlake Point through building heights that ensure the sharing of views to significant land marks and encourage appropriate response to the natural topography.   |
| C22. | Where appropriate, new development is to adopt the predominant height and shape of adjoining development and have similar bulk and mass, taking into account the size and shape of the lot, with taller buildings or elements of one building placed on the higher parts of the site. |

## Building Setbacks

To ensure that new development:

- a) Provides appropriate relationship to the existing streetscape, by ensuring uniform built form patterns in new development;
- b) Ensures that new development contributes to the public domain in Mortlake Point by providing front setbacks that ensure a comfortable street environment for pedestrians in terms of providing solar access, appropriate human scale and a healthy environment for street vegetation;
- c) Strengthens the relationship of new development in Mortlake Point to significant landmarks in the immediate and broader context; and
- d) Provide side and rear setbacks that provide adequate opportunity for ventilation, solar access, view sharing and privacy in residential buildings.

### Controls

|      |  |
|------|--|
| C23. | The front setback is 7.5 metres on all sites.  |
| C24. | On the frontages to Northcote Street, Edwin Street, McDonald Street and Bertram Street, a minimum frontage of 7.5 metres is required to facilitate vista termination and visual access to significant views to the west. |
| C25. | Where Non-Residential development is directly adjacent to Residential development, development is set back at least 4.0 metres from the side and rear boundaries.  |
| C26. | All other residential development is to be set back a minimum 3 metres from the side and rear property boundaries.   |

## Foreshore access

### Controls

|      |   |
|------|---|
| C27. | Foreshore access is to be encouraged and promoted by securing public access to the foreshore areas of open space for improvement of and linkages with local and regional areas of open space. |
|------|---|

|      |   |
|------|---|
| C28. | All development on land located along the foreshore in the area to which this DCP applies is to ensure that adequate public access is provided, to a width of eight (8) metres. |
| C29. | The Council is to consider all opportunities to increase public access to the foreshore through acquisition, dedication or right-of-way.  |

## Streetscape and Public Domain

### Objectives

- O7 To create a high quality environment for local residents and workers in Mortlake Point;
- O8 To ensure that new development within Mortlake Point makes a positive contribution to the streetscape and public domain in the area by ensuring a safe, attractive and comfortable environment; and
- O9 Ensure that development includes aspects of landscaping that add to the habitat values of the area.

### Controls

|      |   |
|------|---|
| C30. | Mid-block connections are to be provided for pedestrians on large sites, in particular those sites directly abutting public foreshore areas. Links should be a minimum of 3 metres in width and where appropriate, be dedicated as public right of way. |
| C31. | Landscaping is to be utilised by development to encourage improved pedestrian amenity through the provision of shade-giving trees spaced at regular intervals of at least 6 metres.   |
| C32. | Landscaping should incorporate, where possible, native vegetation to improve the habitat potential of the area.   |
| C33. | Pedestrian access is to be clearly legible from the street.   |

### K14 Pelican Point, Pelican Quays and Phillips Landing, Concord



Figure K14-1 Aerial photo (source: nearmap.com)

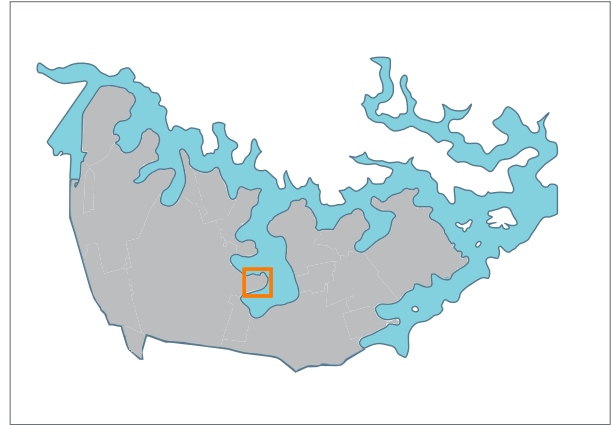

Figure K14-2 Council area map

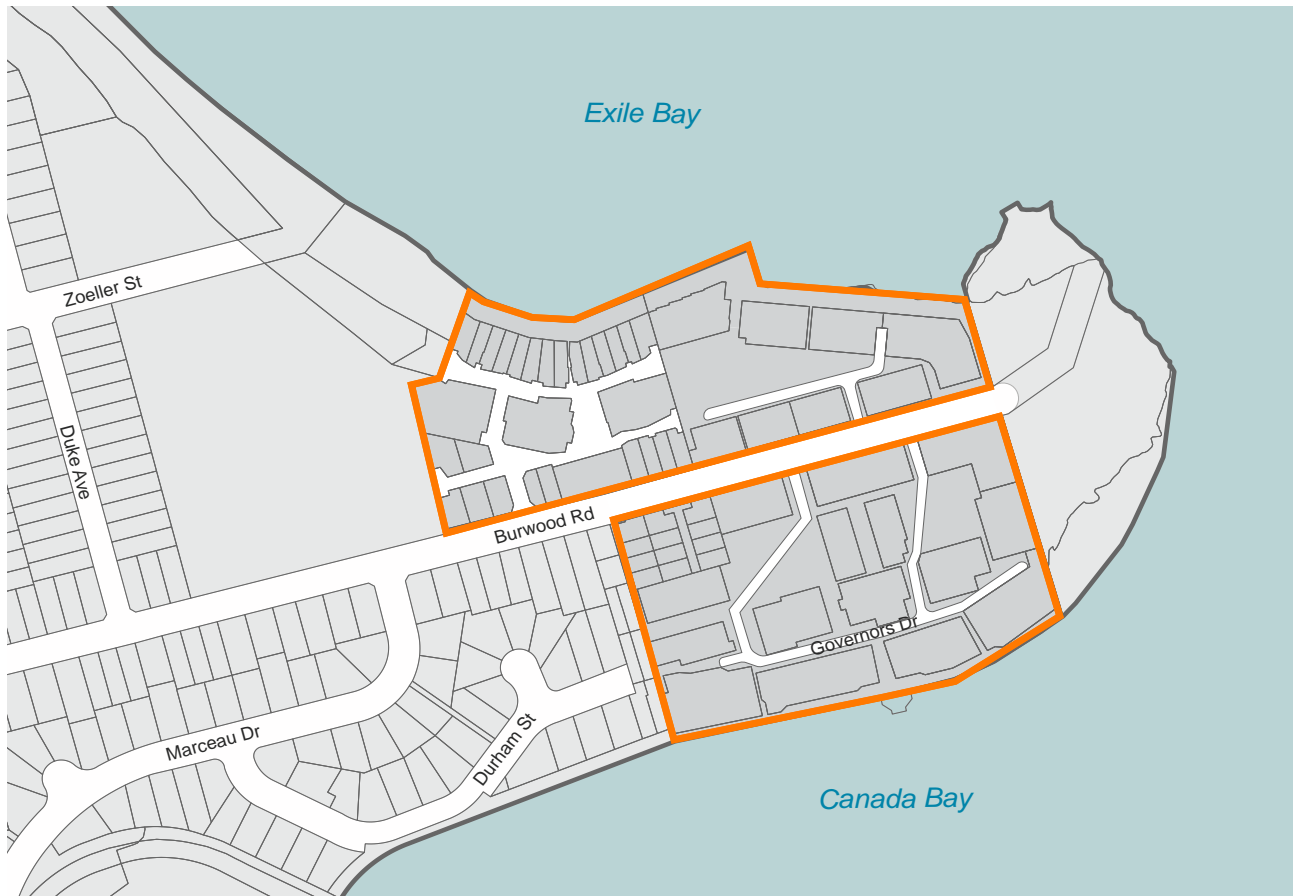

Figure K14-3 Pelican Point, Pelican Quays and Phillips Landing, Concord - Location Plan



### K14.1 General objectives

- O1. The development of the site shall promote public access to and along the waterfront for residents and the general public; and
- O2. To ensure that the development of the site does not cause detriment to the public enjoyment of the foreshore, by providing standards for development, including height, site cover and density, minimum standards of landscaped areas, and design standards for driveways, and materials and finishes of the buildings, etc.

### K14.2 Specific provisions

#### Development Density

| Controls |  |
|----------|--|
| C1.      | The Council shall not consent to any residential development of the land to which this plan applies if the total dwelling density exceeds forty-five (45) dwellings per gross hectare. |

#### Public Foreshore Access

| Controls |   |
|----------|---|
| C2.      | Provision shall be made for public access to the foreshore of the Parramatta River. The requirement in this regard is to be a corridor with a depth of thirteen point five (13.5) metres measured from the relevant property boundary or where that boundary comprises a seawall, battered embankment or the like, 13.5 metres from the top of that wall or embankment and for the full extent of any frontage to the Parramatta River. |
| C3.      | The area for public access shall be landscaped and maintained to Council's satisfaction and include a pedestrian pathway with a minimum width of two (2) metres.  |

### Setbacks and Building Lines

| Controls |   |
|----------|---|
| C4.      | The following Building Lines are imposed: <ol style="list-style-type: none"> <li>To the foreshore. 13.5 metres. (Note: For the purpose of this clause, the building line shall be measured from Medium High Water Mark or where existing, the top of any seawall);</li> <li>To Burwood Road, generally 9 metres, with an absolute minimum of 7.5 metres at any point;</li> <li>To Bayview Park, 9 metres; and</li> <li>To any boundary other than as in a), b) or c) 5 metres.</li> </ol> |
| C5.      | Buildings which exceed two storeys in height shall be setback, on average, as follows: <ul style="list-style-type: none"> <li>From the foreshore, 20 metres; and</li> <li>From Burwood Road, 15 metres.</li> </ul>  |

#### Height of Buildings

| Controls |  |
|----------|--|
| C6.      | Buildings within 20 metres of the foreshore or within 15 metres of Burwood Road, shall generally not exceed a height of two (2) storeys.   |
| C7.      | Buildings generally shall not be in excess of three (3) storeys.   |
| C8.      | Buildings generally shall have a height no greater than fifteen (15) metres where the height is measured from ground level to the highest point of the roof at any place.                                |
| C9.      | No external wall of any building shall have a vertical rise of more than two (2) storeys without some architectural feature which interrupts the vertical plane of that wall, to Council's satisfaction. |

## Site cover

### Controls

- |      |  |
|------|--|
| C10. | The total site cover of all buildings within the development shall be equal to or less than 35% of the total site area for buildings of two or more storeys. |
|------|--|

## Driveways and Paved Areas

### Controls

- |      |   |
|------|---|
| C11. | Driveways and paved areas should be of brick or cobblestone pavers or the like, selected to complement the materials and finishes and landscaping of the development. |
|------|---|

## Materials and Finished of Main Buildings

### Controls

- |      |   |
|------|---|
| C12. | The buildings shall be predominantly masonry construction with tiled roofs. External materials and finishes and the architectural style and features such as balconies, gables, etc. shall reflect the predominant style and character of existing residential development within the City of Canada Bay Council, particularly the 'California Bungalow' Federation and related influences. |
|------|---|

## General

### Controls

- |      |  |
|------|--|
| C13. | The sandstone kerbing to Burwood Road is to be maintained. |
|------|--|

# K15 Rhodes Corporate Park



Figure K15-1 Aerial photo (source: nearmap.com)

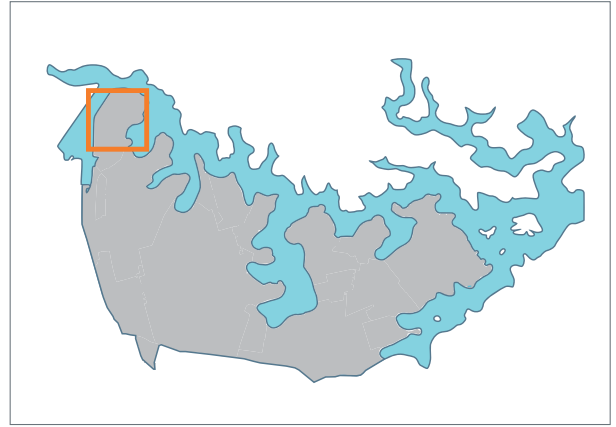

Figure K15-2 Council area map

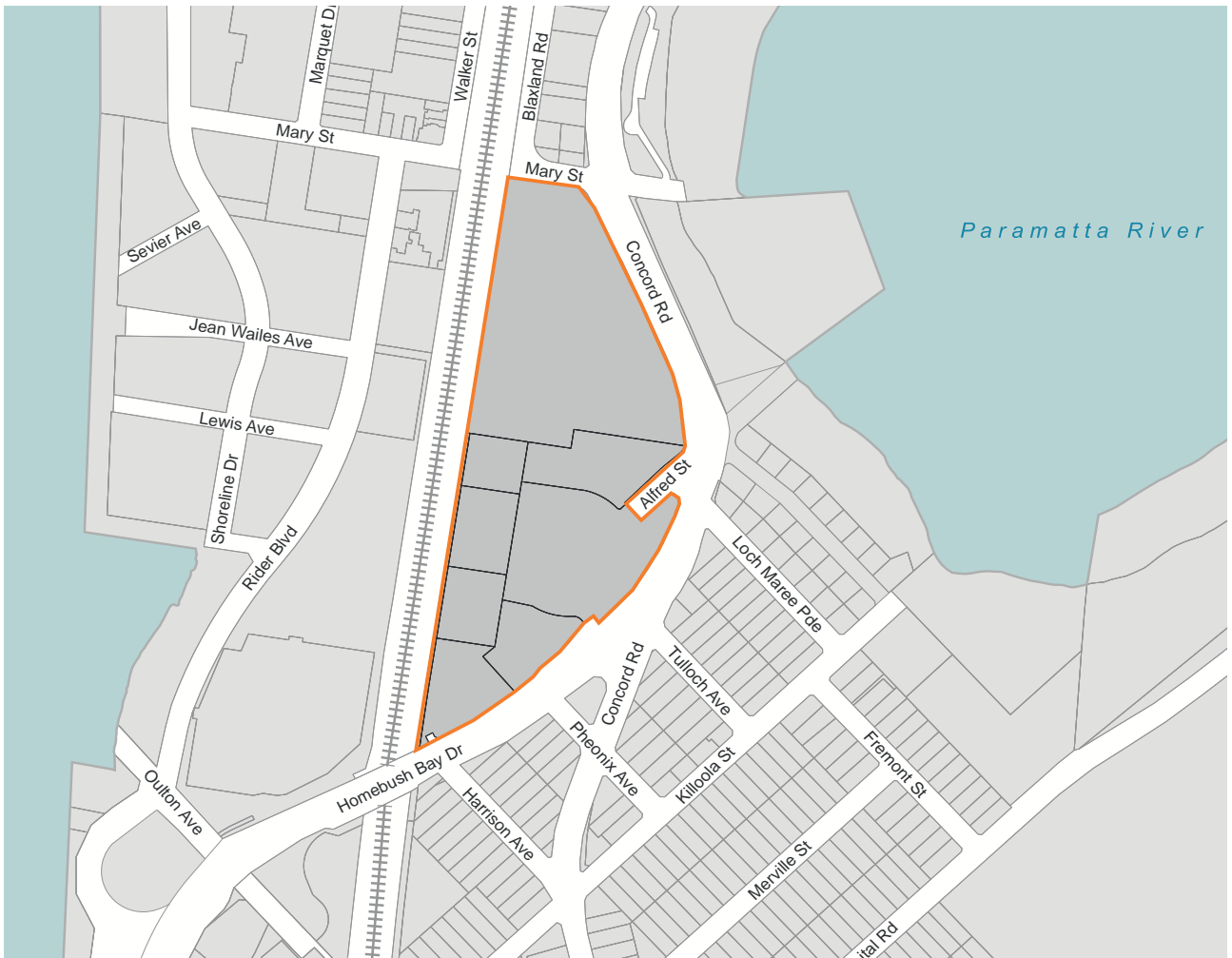

Figure K15-3 Rhodes Corporate Park - Location Plan



### K15.1 General objectives

- O1 To encourage a high standard of modern business park development;
- O2 To ensure new development complements the existing “Digital” development;
- O3 To provide a range of office and light industrial uses;
- O4 To encourage employment opportunities;
- O5 To enable other land uses that provide facilities or services to meet the day to day needs of workers in the area;
- O6 To encourage the erection of buildings suited to development requiring large floor areas, and to discourage small scale uses unless they are of an ancillary or service nature;
- O7 To provide for site planning and layout which includes landscaped set backs to major roads and residential areas and modern building forms;
- O8 To enable the grouping of activities and, where practicable, the sharing of facilities;
- O9 In the case of the land zoned B7 Business Park bounded by Concord Road, Mary Street, Homebush Bay Drive and the Main Northern Railway, Rhodes, to ensure that any new development is complementary in scale, siting, form, materials, landscaping and height with the buildings on the eastern side of the Main Northern Railway; and
- O10 To facilitate public access throughout the zone.

### K15.2 Specific provisions

#### Building Setbacks

| Controls |   |
|----------|---|
| C1.      | Building set-backs shall be provided to present a “buildings in parkland” image consistent with the “business park” nature of the zoning, particularly in relation to Concord Road and Alfred Street.                 |
| C2.      | A minimum set-back of 15m and an average set-back of 20m to Alfred Street shall be provided. The two standards are intended to provide for stepped or articulated building elevations.                                |
| C3.      | Buildings should be set-back from Concord Road to achieve a compatible alignment to the Digital building.   |
| C4.      | The remnant landscaping that was retained within the Concord Road frontage shall be retained.   |
| C5.      | Within the setback to the Main North Rail Line the public access/cycleway required by the original consent to Digital linking Mary Street to Alfred Street shall be identified and timing of construction identified. |

## Building Height

| Controls |   |
|----------|---|
| C6.      | Building heights should generally be consistent with the existing Digital building, and should be related to building siting intended to avoid overshadowing of residential property in Alfred Street.  |
| C7.      | Buildings should not exceed a height of 6 storeys above finished ground level and should not exceed the relative levels that are established by the roof heights of the existing Digital buildings.   |
| C8.      | The Council may require parts of a building to be of a lesser height so as to avoid overshadowing on residential land.  |
| C9.      | The Council may approve where it is satisfied that: <ul style="list-style-type: none"> <li>Any such part of a building is substantially separated from residential land; and</li> <li>The variation in height will contribute to a better form and arrangement of buildings on the site.</li> </ul> |
| C10.     | Building should be sited, restricted in height or include stepped facades in order to limit overshadowing of residential properties in Alfred Street. In this regard properties should not be overshadowed between the hours of 9am and 3pm on June 21st.   |
| C11.     | Council may exclude plant and lift motor rooms and any screening structure, parapet walls and roof top amenities from any consideration of building height, other than shadow effects.  |

## Building Materials

| Controls |  |
|----------|--|
| C12.     | Building materials and colours and glazing should be selected to achieve compatibility with existing development, without necessarily seeking uniformity.<br><br>The design intent should be specified in the development application. |

## Landscaping

| Controls |  |
|----------|--|
| C13.     | Site landscaping should be generally designed to reinforce the intended “buildings in park” image.   |
| C14.     | A unified landscaping theme should be applied to the frontages to Concord Road and Alfred Street. It will be necessary to justify any intended interruption to the established theme, either by way of fences, walls and the like or by plant materials. |
| C15.     | Development on the southern part of the site should extend and complement the existing landscaped courtyard in the Digital complex.  |

## Subdivision

| Controls |   |
|----------|---|
| C16.     | Proposals for subdivision will need to demonstrate that subdivision will not prejudice the reasonable development of other lands in the zone, or hinder the attainment of objectives to achieve an integrated and compatible development of the overall site. |



## Types of Use

| Controls |   |
|----------|---|
| C17.     | <p>The types of use Council seeks to encourage on the site should have the following characteristics:</p> <ul style="list-style-type: none"> <li>• A requirement for large floor areas;</li> <li>• A requirement for a substantial corporate presence in a modern campus style environment;</li> <li>• Quiet and clean operations;</li> <li>• No requirement for significant heavy vehicle access; and</li> <li>• No requirement for extensive public visits or “walk-in” trade.</li> </ul> |
| C18.     | <p>Small scale uses are discouraged unless they are ancillary to or provide services to the overall development.</p>  |
| C19.     | <p>In the case of a development application which involves a high proportion of office type space intended to be used for office type purposes, the Council shall take into consideration whether the proposed use would be more appropriately located in a business zone in the City of Canada Bay.</p>  |

## Relationship with Residential Zones

| Controls |   |
|----------|---|
| C20.     | <p>As set out above, the Council will consider development applications in terms of the potential effect on residential zones, including visual impact, overshadowing, overlooking, noise, lights and traffic.</p>  |
| C21.     | <p>Hours of operation will generally be limited to between:</p> <ul style="list-style-type: none"> <li>• 7am and 6pm Monday to Friday; and</li> <li>• 9am and 3pm Saturday.</li> </ul> <p>Except for:</p> <ul style="list-style-type: none"> <li>• Routine after hours activity (cleaning, etc);</li> <li>• Normal incidental out-of-hours activity, where premises are not open to the public or for deliveries, etc;</li> <li>• Any incidental seasonal requirement (e.g. stocktaking); and</li> <li>• Any requirement for extended hours for operating computer equipment, international communications or similar.</li> </ul> |
| C22.     | <p>Where it is intended that a use operates outside the specified hours, justification should be included in the development application. This will need to demonstrate that operation out-of-hours will have no discernible impact on any adjoining residential land.</p>  |

**This page was intentionally left blank**

## K16 Rhodes East

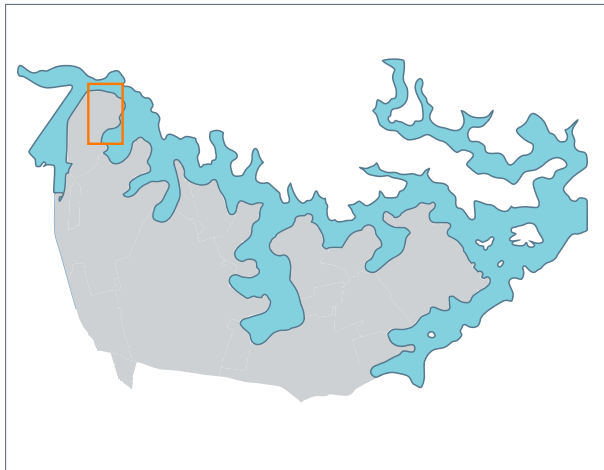

### K16.1 Introduction

This Development Control Plan (DCP) establishes a framework to guide development in the Rhodes East Priority Precinct (the Precinct).

#### Name of this DCP

This DCP is called the Rhodes East Development Control Plan. The DCP has been prepared pursuant to the provisions of the Environmental Planning and Assessment Act 1979 (the Act).

#### Land to which this DCP applies

This DCP applies to development indicated within the boundary of the Rhodes East Precinct as shown in **Figure K16-1**.

#### Purpose of this DCP

The purpose of this DCP is to guide the future development of the Precinct by:

- identifying the vision, development principles, key elements and indicative structure for the Precinct;
- communicating the planning, design and environmental objectives and controls against which the consent authority will assess development applications;
- ensuring the orderly, efficient and environmentally sensitive development of the Precinct; and
- promoting a high quality urban design outcome.

#### Relationship to other plans

This DCP adopts the following provisions of the City of Canada Bay Development Control Plan 2017:

- Part B - Notification and Advertising
- Part C - General Controls with the exception of C3.1 and C3.2
- Part D - Heritage
- Part E - Residential Development E2.5, E2.6 and E4.2
- Part H - Signage and Advertising
- Part I - Child Care Centres.

A provision of this DCP will have no effect to the extent that:

- it is the same or substantially the same as a provision in the Canada Bay Local Environmental Plan 2013 (CBLEP 2013) or another environmental planning instrument (EPI) applying to the same land; or
- it is inconsistent with a provision of the CBLEP 2013 or another EPI applying to the same land, or its application prevents compliance with a provision of the CBLEP 2013 or another EPI applying to the same land.

In either case the provision in the CBLEP 2013 or other EPI will prevail.

This DCP should be read in conjunction with:

- The Canada Bay Local Environmental Plan 2013
- The City of Canada Bay Engineering Specifications
- The City of Canada Bay Contaminated Land Policy
- The City of Canada Development Contribution Plans
- The City of Canada Bay Planning Agreements Policy

The onus is on any prospective applicant to confirm with Council if there are any additional or updated documents.

#### Apartment Design Guide compliance

The State Environmental Planning Policy No 65 - Design Quality and Residential Apartment Development applies to residential flat buildings, shop top housing and mixed use development with a residential accommodation component in the Precinct.

--- Land to which the DCP applies



Figure K16-1 Land to which this DCP applies



### Consent authority

Unless otherwise authorised by the Act, City of Canada Bay Council is the consent authority for all development in the Precinct to which this DCP applies.

### Application of this DCP

This Development Control Plan (DCP) is to supplement the Canada Bay Local Environmental Plan (LEP) 2013 and provide more detailed provisions to guide development.

This DCP has been made in accordance with the Environmental Planning & Assessment Act 1979 (the Act) and must be read in conjunction with the provisions of Canada Bay LEP 2013.

Compliance with the provisions of this DCP does not necessarily guarantee that consent to a Development Application (DA) will be granted. Each DA will be assessed having regard to the LEP, this DCP, other matters listed in Section 4.15 of the Act, and any other policies adopted by the consent authority.

If there are circumstances when it is not relevant to comply with the controls in this DCP, applicants must provide a written submission clearly demonstrating compliance with the objectives of this DCP, and detailing the reasons the control/s should be varied. The proposed variation must result in a better outcome and meet all objectives of this DCP. The submission must also clearly demonstrate the variation sought will not adversely impact on the local amenity.

### Role of the draft Precinct Plan

The Rhodes East draft Precinct Plan at **Figure K16-3 on page K-122** shows how the overall Precinct may develop over time. It is intended as a guide to demonstrate how the vision, overarching objectives, development principles and key elements for the Precinct may be achieved.

### Consistency with objectives and controls

Clauses in this DCP contain objectives and controls relating to various aspects of development. The objectives enable Council and applicants to consider whether a particular proposal will achieve the development outcomes established for the Precinct. The controls, if met, mean that development would be consistent with the objectives.



Above: Artist impressions of the desired future look and feel of Rhodes East Precinct

## K16.2 Desired Future Character

### Vision for Rhodes East



#### Rhodes East Vision Statement

*"Rhodes East will be a model for sustainable, low-rise high density development, which builds upon the existing character and heritage of the area. It will provide more high quality housing choice, close to public transport and catering to a variety of household types.*

*It will be supported by connections to the water, and local streets will be redesigned to support walking, cycling and use of public transport. Improved amenity will encourage residents and visitors to spend time and continue to take pride in the area."*

**Overarching Objectives**

**Planning**

Ensure Rhodes East can meet the challenges of the future by building sustainability and longevity into planning, design and commercial capability from the start.

**Active transport**

Design integrated transport services and experiences that prioritise walking, cycling and the use of public transport.

**Affordable housing**

Provide affordable housing options for key workers in the area, for example people working in occupations such as teaching, child care, policing or nursing.

**Density with a human scale**

Deliver buildings with podiums and a range housing typologies that promote activity on the lower levels of buildings. The range of built forms will result in more open space, more sunlight into buildings, and a closer connection to the ground.

**Waterfront access**

Provide enhanced public access to the Parramatta River foreshore, including the provision of housing and public open space with views to the water.

**Public spaces**

Provide a range of high quality, pedestrian prioritised public spaces that are safe for gathering and socialising.





## Design Principles

### A place led approach

The redevelopment of Rhodes East has been framed around a place led approach that builds on the existing urban fabric and character to create a pedestrian friendly human scaled outcome.

Traditional city-building has created the world's most successful urban places which typically consist of a broad range of lots, blocks and buildings assembled to create livable, mixed use walkable communities. Development was incremental, with a diversity of lot sizes and building types, ranging from the very small to the very large, and also a strong public realm.

Throughout the consultation process, the local community has consistently affirmed a desire to celebrate the inherent character of Rhodes East. As a result, the existing urban structure has informed a fine grain human scale urban renewal that will provide a genuine point of difference and create a unified community that is greater than the sum of its parts.



### A peninsula of choice

Rhodes East is an established urban area with an existing community. It contains a number of different places, each with its own unique identity and character, contributing to the overall experience and attraction of the Peninsula. The commitment to delivering 5% Affordable Housing combined with the definition of a housing mix within the LEP, will ensure that Rhodes East provides choice and variety to the Peninsula.

### Urbanity through density

Successful urban renewal projects increase intersection density or the number of intersections in a given area. Intersection density corresponds closely to block size, so the greater the intersection density, the smaller the block. Small blocks make neighbourhoods more walkable and, in conjunction with smaller redevelopment sites, creates the pre-conditions to deliver authentic fine grain, human scale development in accordance with the Rhodes East Vision for Cavell Avenue Precinct.



### Opportunities for a modal shift

A key focus is to create an urban structure that maximises opportunities for walking, cycling and public transport patronage. Improving connectivity through additional street and pedestrian connections is critical to achieving the modal shift required to support the new Rhodes East community.

An integrated high quality urban design outcome, not just density, is required to engage and stimulate the pedestrian, particularly along key desire lines, improving the pedestrian experience.

Active transport infrastructure, and reduced or low parking rates within close proximity to public transport, is part of an integrated urbanity model. Modal shift is also supported by creating the environment to support active transport including 'Context Sensitive Streets', a well connected access network, creating more compact blocks, and increasing intersection densities.

### A fine-grain pedestrian friendly environment

A fine-grain pedestrian friendly environment is supported by the 'high-low' built form model, where height is distributed in a manner that allows for good solar access, orientation and view corridors in addition to active facades and ground floor controls.

Desired densities can be achieved without overshadowing community open space, parks or other buildings by strategically locating the tallest elements on the south west of blocks with the balance of development being low to mid rise.

### A feasible and sustainable outcome

A liveable, walkable and sustainable environment will encourage active transit and reduce reliance on private vehicle trips. This not only reduces local traffic volumes and eases congestion, but provides healthier lifestyles and activates the public realm.

Site specific floor space ratio bonuses is available to incentivise developers to deliver new streets ensuring the additional population can be sustained as the development progresses. Similarly, floor space ratio bonus is available for delivery upon higher sustainability targets set out in the LEP.

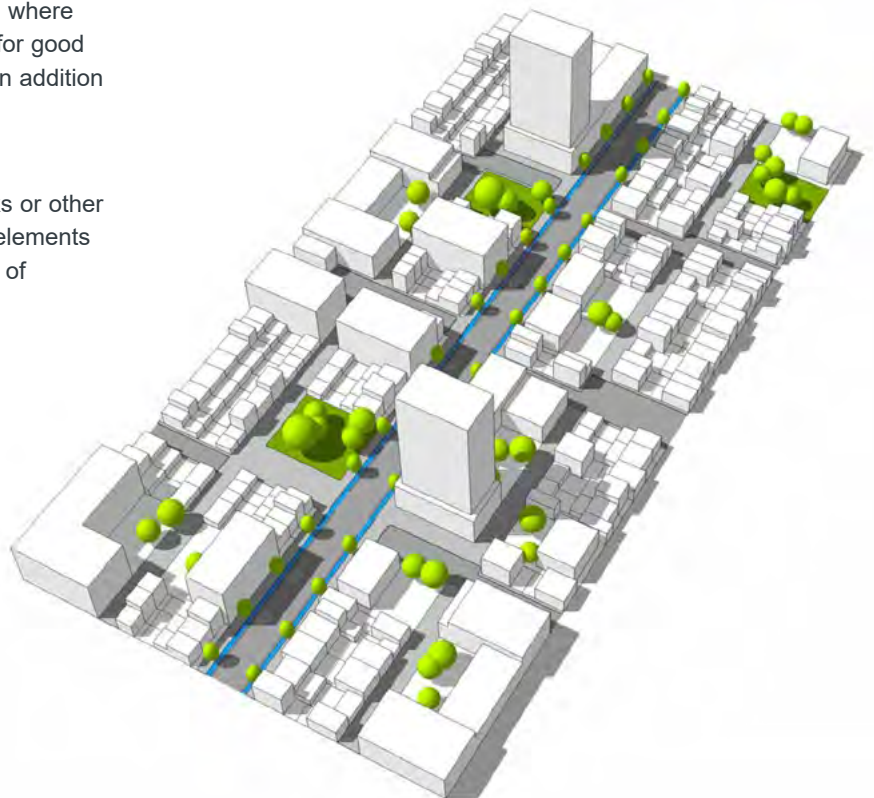

## Character Areas

The following Character Areas, shown in **Figure K16-2**, have been identified for Rhodes East based upon their function, use, street pattern and built form attributes:

- *Station Gateway East Character Area* - a key transport hub located between Rhodes Station and Concord Road, with a character influenced by adjoining built form and functions.
- *Leeds Street Character Area* - a predominately light industrial area with large building structures, which is heavily transport dominated (vehicles and river traffic).
- *Cavell Avenue Character Area* - centrally located area, situated on the most elevated part of the Investigation Area, with a mix of residential and community uses.

## Character Statements

### Station Gateway East

This character area will proudly announce arrival at Rhodes East from the south and guide people to the Station and Mcllwaine Park. The built form will reflect its location adjacent to the Station with increased density and encourage the use of public transport as opposed to the private vehicle.

The built form will provide an active, mixed used podium and street level frontage with formal landscaping that complements the character of Mcllwaine Park.

There will be street level activation and a safe, pedestrian friendly environment will be prioritised to promote connectivity between the Station, across Concord Road, into Mcllwaine Park with a link to Parramatta River.

### Leeds Street Character Area

This character area will provide a multi-modal, water-based destination. The Leeds Street Character Area will introduce meaningful visual and physical connections to the water in addition to a vibrant mix of uses. The lifestyle and activities promoted within this character area will prioritise pedestrians and facilitate human interaction.

Buildings will be flexible and multi-purpose and, whilst they may have larger floor plates, an active street frontage to public areas will be created. The built form will respond to the northern aspect of the character area through the sensitive location of height combined with block permeability and building separation ensuring pedestrian level views of Parramatta River from the centre of Rhodes East.

### Cavell Avenue Character Area

The Cavell Avenue Character Area will largely consist of residential and community uses through a 'density done well' approach that will deliver a diversity of heights and human scale built form focusing on a balance between increased housing, public/ private amenity and an active and safe pedestrian environment.

Future development will facilitate enhanced connectivity, between the east and west of the Peninsula and to public transport and will also create localised 'place' features along key desire lines and view axes.

**CHARACTER AREAS**

-  Station Gateway East
-  Cavell Avenue
-  Leeds Street
-  Land to which the DCP applies

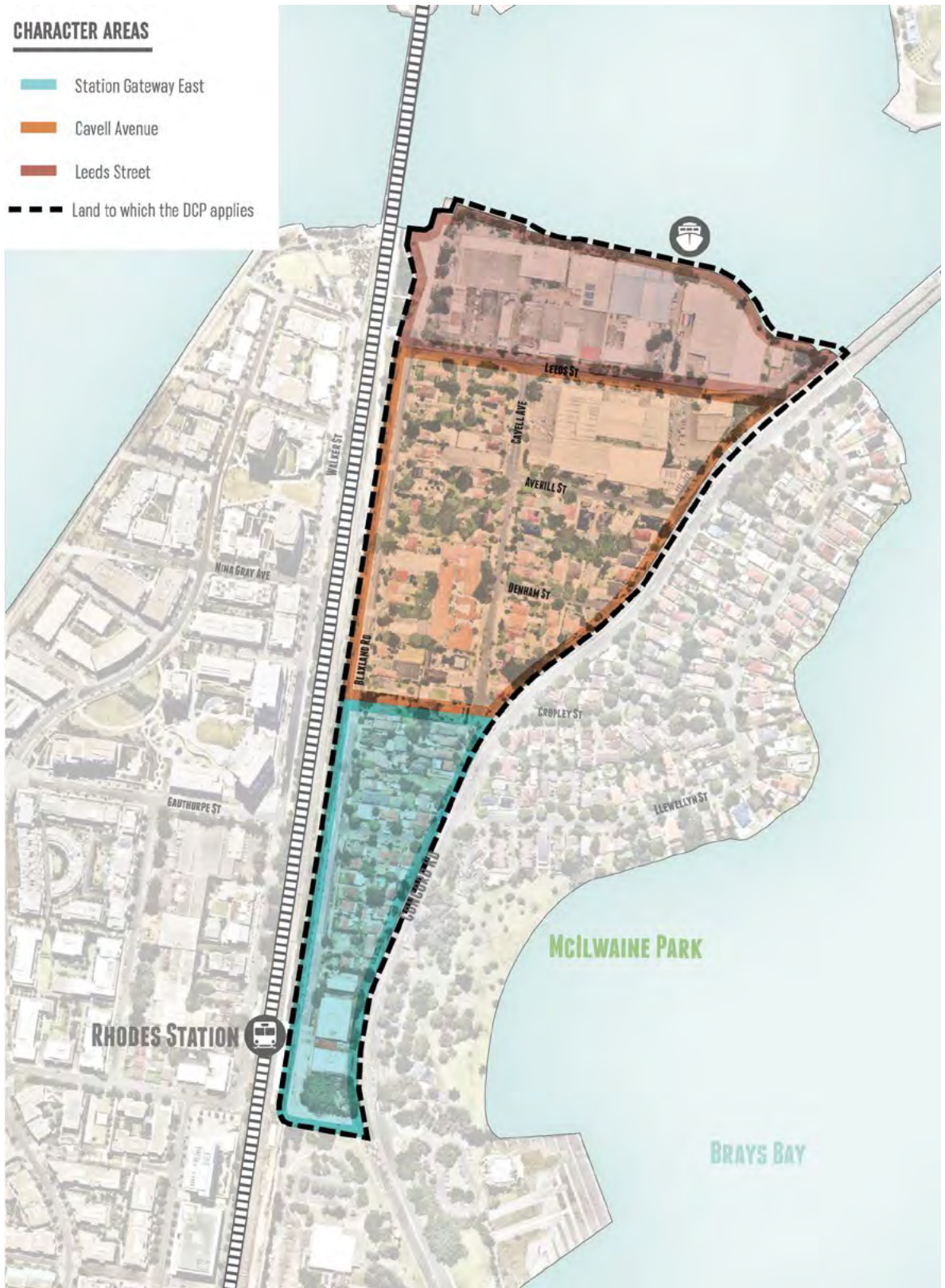

Figure K16-2 Character areas



## Rhodes East Precinct Plan

Development is to be generally consistent with the key elements in **Table K16-1** and the Rhodes East Precinct Plan at **Figure K16-3**.

Where variations are proposed, development is to demonstrate how the vision, development principles, key elements for the Precinct and relevant specific objectives are to be achieved.

**Table K16-1 Key elements of Rhodes East Precinct**

| Land use   |
|--|
| <p><b>Residential</b></p> <ul style="list-style-type: none"> <li>• 3537 new dwellings (8210 population) by 2036 comprising a mix of dwelling types</li> <li>• 5% affordable housing across the Precinct</li> </ul> <p><b>Retail / commercial</b></p> <ul style="list-style-type: none"> <li>• 400m<sup>2</sup> GFA of convenience retail</li> <li>• 4600 m<sup>2</sup> GFA of destination retail</li> <li>• 11,100m<sup>2</sup> GFA of commercial space</li> </ul> <p><b>Education and community</b></p> <ul style="list-style-type: none"> <li>• A new primary school for 1000 students</li> <li>• 300m<sup>2</sup> of publicly accessible plazas at key corners along pedestrian routes, each plaza co-located with non-residential uses on the ground floor of developments.</li> <li>• 1750 m<sup>2</sup> of adaptable community uses space</li> </ul> |
| Movement network   |
| <ul style="list-style-type: none"> <li>• Pedestrian and cycle activity and public transport interchange functions are prioritised</li> <li>• New streets will create a more permeable movement network and increase connectivity</li> <li>• New pedestrian station bridge will increase connectivity and encourage active transport</li> <li>• Interchange upgrades, bus and rail upgrades</li> </ul>  |
| Open space and public domain   |
| <ul style="list-style-type: none"> <li>• New areas of public open space including: <ul style="list-style-type: none"> <li>• Minimum 7500 m<sup>2</sup> of a new foreshore park</li> <li>• Continuous 15m-wide foreshore promenade providing connectivity to the precinct and future ferry wharf</li> <li>• Minimum 550 m<sup>2</sup> Bridge Plaza providing connection between the train station and McIlwaine Park</li> </ul> </li> <li>• New parks plazas improved foreshore access and river activation</li> </ul>  |
| Built form   |
| <ul style="list-style-type: none"> <li>• The built form will be characterised by a mix of residential development supported by commercial, educational and community uses</li> <li>• Building heights range from 1 to 37 storeys incorporating terraces to apartment buildings in addition to a number of taller landmark buildings</li> <li>• Integration of existing heritage items within the development</li> </ul>  |



Figure K16-3 Precinct Plan



### K16.3 Key development parameters

The key development parameters for the Rhodes East Precinct identify metric limits to the size of (amalgamated) lots, their maximum and minimum frontage length, building heights and floor space ratios. An overview of these key controls is provided in **Table K16-2 on page K-127**.

#### Maximum lot size

The maximum lot size control applies to The Cavell Avenue Character Area. This control seeks to limit development that incorporate large floorplates and to protect the values and desired future character of the area.

#### Objectives

- O1 To deliver fine grain, activated and visually interesting developments and streetscapes on a variety of lot sizes.
- O2 To avoid large scale development that dominates the character of an area.
- O3 To facilitate a range of development sizes resulting in built form diversity.

#### Controls

- |     |   |
|-----|---|
| C1. | All new development is to comply with maximum lot size as per <b>Figure K16-4</b> and <b>Table K16-2</b> . Also refer to relevant Local Environmental Plan 2013 clauses and maps. |
|-----|---|

#### Maximum lot frontage length

Maximum lot frontage lengths apply to the Cavell Avenue Character Area.

Similar to the maximum lot size control, the intention is to limit large scale amalgamation and development, particularly in areas that have an existing fine grain lot pattern and narrow frontage widths.

#### Objectives

- O4 To integrate new development into existing fine grain streetscapes and avoid long lengths of continuous, homogeneous development.
- O5 To facilitate a fine-grain built form outcome which creates architectural variety and visual interest along streetscapes.

#### Controls

- |     |  |
|-----|--|
| C2. | All new development is to comply with maximum and minimum frontage length as per <b>Figure K16-4</b> and <b>Table K16-2</b> . Also refer to relevant Local Environmental Plan 2013 clauses and maps. |
|-----|--|



Figure K16-4 Maximum lot size and frontage length plan





### Maximum building height

Building form and scale contribute to the physical definition of the street network and the hierarchy of public spaces. A range of building heights across Rhodes East is encouraged to deliver variety, diversity and different architectural styles whilst ensuring the creation of low-rise, high density development.

Taller buildings are to be located close to key community services and facilities, near the train station before stepping down towards Concord Road. Please refer to *Section K16.6 Built form strategy* for further information.

### Objectives

- O6 To facilitate appropriate growth and housing delivery across the Precinct.
- O7 To locate higher scale residential uses close to Rhodes Station to optimise access to the station facilities and around the mixed use area at Leeds Street.
- O8 To step down heights and density towards the Parramatta River within a human scale, fine grain development pattern.

| Controls |   |
|----------|---|
| C3.      | All new development is to comply with maximum building height as per <b>Figure K16-6</b> and <b>Table K16-2</b> .   |
| C4.      | In selected locations, an increase in permissible height may be possible, linked to the provision and delivery of new streets. Refer to <i>Section K16.3 Bonus Height and FSR</i> of this DCP. Also refer to relevant Local Environmental Plan 2013 clauses and maps. |
| C5.      | Maximum building height are inclusive of floor space bonus achievable through application of Basix Affected Building clause in the Canada Bay LEP.  |

### Maximum floor space ratio

The floor space ratio standards, in tandem with the maximum building heights, allow for taller built form elements to be located within each block, while the remainder of the development would be at lower scale. This minimises overshadowing impacts to adjoining development whilst achieving a high quality, pedestrian friendly public realm and encouraging the provision of a range of building typologies and housing choice.

### Objectives

- O9 To minimise the visual and overshadowing impact of new development on lower scale neighbouring properties and the public domain, by limiting the bulk and scale of new development.
- O10 To protect existing and future open spaces from overshadowing impacts and ensure adequate solar amenity for these open spaces.

| Controls |  |
|----------|--|
| C6.      | All new development is to comply with maximum floor space ratio as per <b>Table K16-2</b> .  |
| C7.      | In selected locations, an increase in permissible FSR may be possible linked to the provision and delivery of new streets and delivery of Basix targets. Refer to <i>Section K16.3 Additional Height and FSR</i> of this DCP. Also refer to relevant Local Environmental Plan 2013 clauses and maps. |

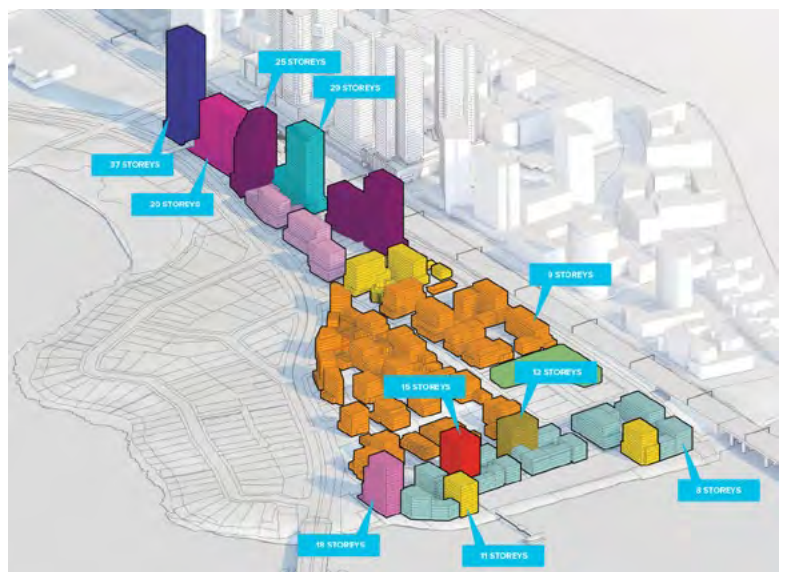

Figure K16-5 Height distribution



Figure K16-6 Maximum building heights plan



**Table K16-2 Overview of key development parameters**

| Cavell Avenue            |  |
|--------------------------|--|
| Max. lot size            | 4,000m <sup>2</sup>                          |
| Max. lot frontage length | 60m  |
| Max. building height     | Up to 36m (11 Storeys) including Basix bonus |
| Max. floor space ratio   | Refer to LEP                                 |

**Transfer of Floorspace and FSR**

The location of two new streets are identified within the Precinct Plan for Rhodes East. These new streets are fundamental to the delivery of the intersection and frontage densities necessary to support the public life envisaged and encourage a modal shift.

An increase to building height and FSR is possible for selected locations identified on **Figure K16-8** to facilitate the provision of the new streets.

**Objectives**

O11 To support/ deliver new streets to improve connectivity within the Precinct.

**Controls**

- C8. Additional heights and FSR apply to selected locations as per **Figure K16-8** and are linked to the delivery of new streets as outlined above.
- C9. Across the precinct, an increase in permissible FSR is possible linked to delivery of BASIX targets.

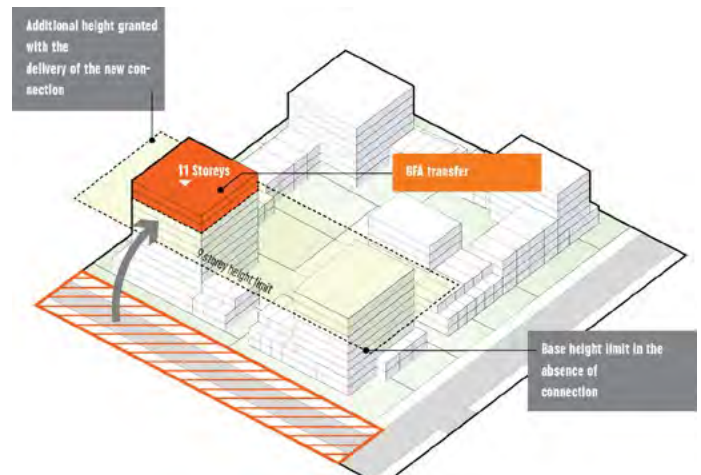

Figure K16-7 Explanatory diagram of bonus height and FSR



Figure K16-8 Bonus height and FSR plan



## K16.4 Public Domain

### Street network and access

#### Context sensitive streets

Context Sensitive Street design aims to balance the often competing objectives of traffic capacity with place amenity, or place-led character, considering both character and capacity. Streets that connect key destinations will support and prioritize pedestrians and cyclist through cycleways, wider pedestrian paths and shade trees.

The proposed street types shown in **Figure K16-9 to Figure K16-14** reflect this intent, and support the land use, density and street function of the different Character Areas.

A number of new connections are proposed to improve connectivity and promote pedestrian activity across the Precinct. Their addition encourages a finer grain of development as smaller, more compact blocks are created to provide a human scaled environment that has the ability to accommodate a range of housing types and sizes.

The two new streets shown in **Figure K16-10** provide east-west connections between Cavell Avenue and Blaxland Road. It is proposed that these streets will be delivered via transfer of floorspace as outlined in *Section K16.3 (Transfer of Floorspace and FSR subheading)* of this DCP.

### Objectives

- O1 To create a public domain that supports and encourages pedestrian movement through activated streets and human-scale development fronting onto a defined hierarchy of streets.
- O2 To support the concept of a fine grain, vibrant streetscape experience whilst ensuring that a viable built form siting and access solution can be achieved.
- O3 To provide a clear street hierarchy and a more permeable urban structure.
- O4 To provide a safe space for walking and cycling and offer universal access, providing greater independence for children and families as well as the elderly and disabled.
- O5 To strengthen the landscape character and quality of the Precinct through the retention and enhancement of existing and planting of additional street trees and landscaping.

| Controls |   |
|----------|---|
| C1.      | The existing street pattern is to be retained and new streets are to be provided as per <b>Figure K16-10</b>  |
| C2.      | Street design including the upgrade of existing and the delivery of new streets are as per <b>Figure K16-9</b> and <b>Figure K16-11 to Figure K16-14</b> . For further guidance refer to the <i>Canada Bay Rhodes East Public Domain Plan</i> . |

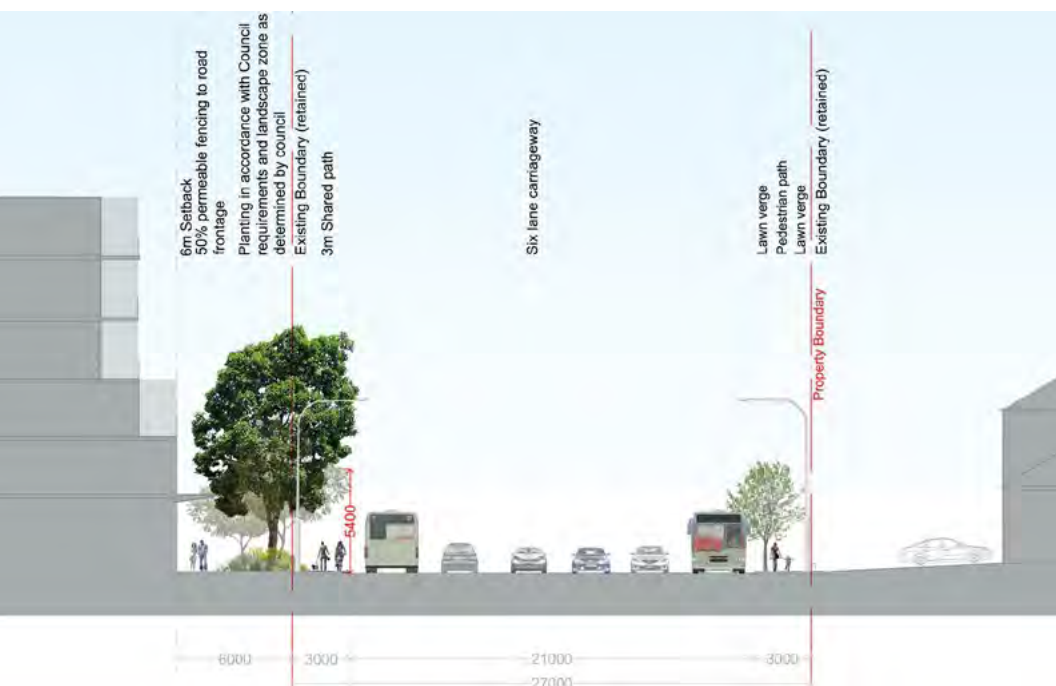

### Greenway Boulevard (Corridor Road)

An arterial road with generous setbacks to allow for mature landscaping and wide footpaths creating a buffer between Concord Road and the adjacent development.

Figure K16-9 Street section - Greenway Corridor



Figure K16-10 Street network plan





Figure K16-11 Street section - Commuter Street

**Commuter Street  
(Blaxland Road)**

An important link between the Leeds Street Foreshore Park / Ferry Wharf and the station, with a dedicated cycleway connecting commuters and residents to these key destinations. New tree planting between parking bays will provide screening of the rail infrastructure and shade for pedestrians.

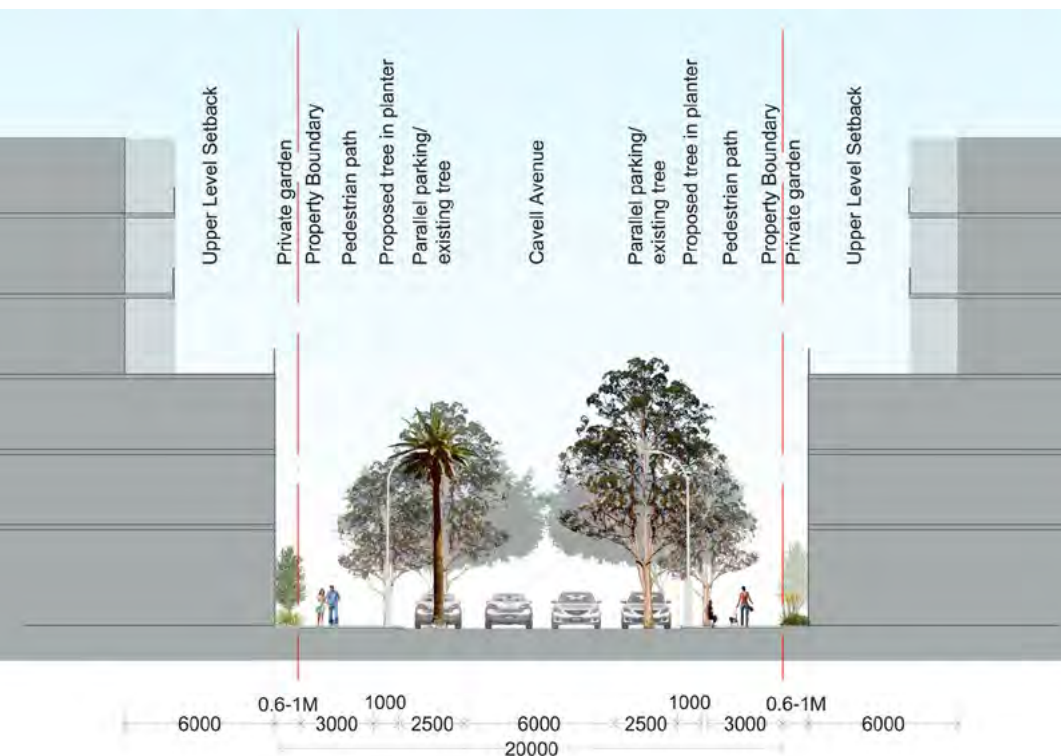

Figure K16-12 Street section - Community Spine

**Community Spine  
(Cavell Avenue)**

An important connection between Leeds Street Character Area and Station Gateway East, providing access to key existing community uses such as the Coptic Church, Community Hostel and Community Centre.

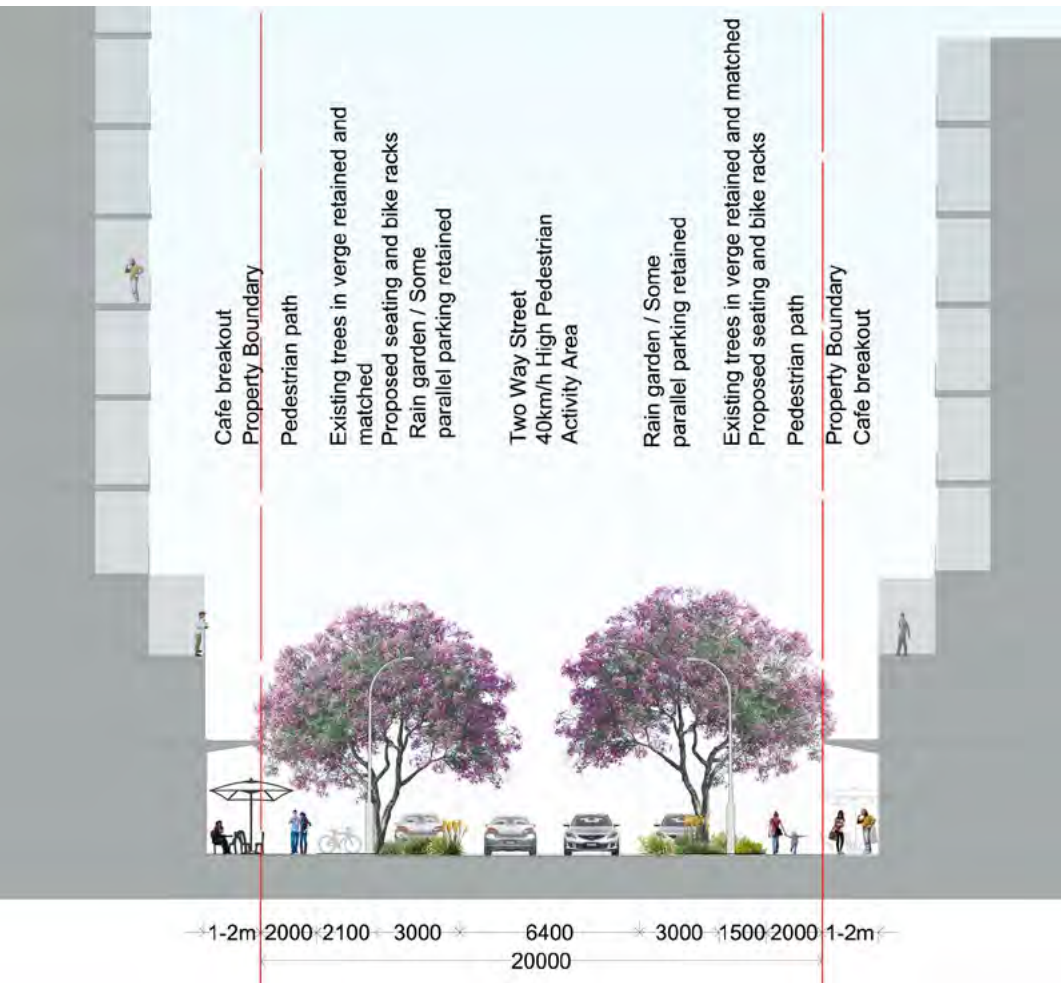
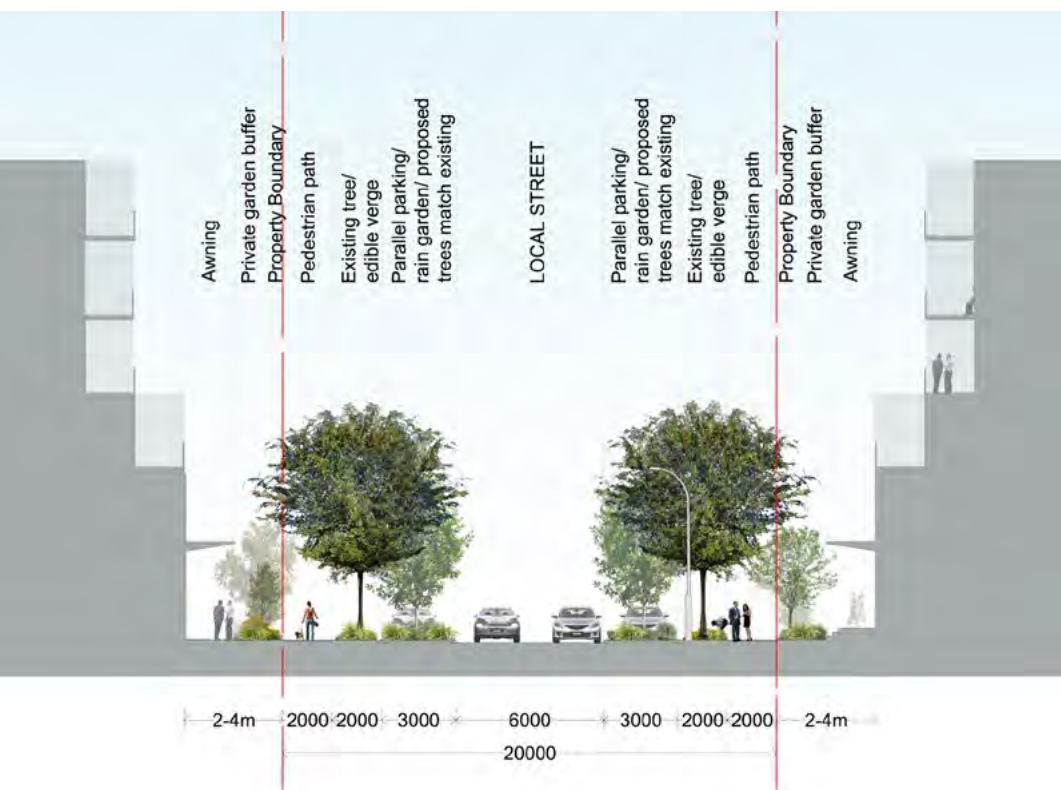

Figure K16-13 Street section - Destination Street

**Destination Street (Leeds Street)**

A shared street where pedestrians have priority, reflective of the intent to create an activated mixed use destination around the Leeds Street Foreshore Park.



**Local Street (Averill Street, all new streets)**

Fine grain diverse streets that offer pedestrian amenity with landscaping that provides seasonal variation.

Figure K16-14 Street section - Local Street



## Pedestrian and cycle network

The proposed network of pedestrian and cycle paths connects to key destinations within and beyond the Rhodes Peninsula and encourages active transport that benefit the health of individuals and wider community, including less air and noise pollution from private motor vehicles.

The key improvements include:

- Linking into broader foreshore network beyond Rhodes East Precinct
- Connecting separated cycleway and pedestrian paths within the Leeds Street Character Area to the Rhodes West foreshore promenade
- Widening and upgrading pathway connections under the northern foreshore bridges
- Delivering a designated 'Commuter Cycleway' along Blaxland Road
- Delivering new pedestrian links over the railway and Concord Road to create a continuous pedestrian loop within Rhodes.

## Objectives

- O6 To provide a convenient, efficient and safe network of pedestrian paths and cycle ways between key locations within and beyond the Precinct.
- O7 To encourage more physically active lifestyles and support a modal shift reducing car ownership and reliance.
- O8 To ensure development addresses the pedestrian and cycle network and enables ease of access to entry lobbies, links and bicycle facilities.

## Controls

|     |   |
|-----|---|
| C3. | The pedestrian and cycle network is as per <b>Figure K16-15</b> and designed as per the <i>Canada Bay Rhodes East Public Domain Plan</i> .  |
| C4. | Provide spaces on private property that enable pedestrian access and use (eg. Connections within a site, lobbies and the like) that are accessible and at-grade.  |
| C5. | Bicycle facilities, such as parking, secure storage and end-of-trip facilities are required to be easily accessible from the public domain and conveniently located near entrances and/or lifts of new development. |
| C6. | The location of the building entrances must be clearly visible from the public open space network to support surveillance and safety of the pedestrian and cycle network.   |



Figure K16-15 Pedestrian and cycle network plan



## Open Space Network

The open space network in Rhodes East is envisaged to become a continuous network of 'Green Streets' and parks over time. New development on land adjoining this network plays an important role in supporting its quality, usability and pedestrian priority.

### Objectives

- O9 To provide an integrated, continuous open space network that links existing and proposed open spaces within the Precinct and beyond.
- O10 To enhance the everyday quality of life for residents, workers and visitors by providing new quality public open spaces including pocket parks, plazas and green links.
- O11 To ensure that new development adjoining the open space network complements the landscape character and supports ease of access, public use, safety and pedestrian priority.

### Controls

|      |   |
|------|---|
| C7.  | The open space network is as per <b>Figure K16-16</b> and designed as per the <i>Canada Bay Rhodes East Public Domain Plan</i> .  |
| C8.  | Private spaces that are visible but physically inaccessible to the general public (i.e. front setbacks, communal open space and the like) are designed so that they integrate with the treatment of the open space network. |
| C9.  | The selection of furniture, pavement and lighting for private space visible from the public domain is to demonstrate a similar style and treatment as outlined in the <i>Canada Bay Rhodes East Public Domain Plan</i> .    |
| C10. | Public domain in Green Streets are to be configured and designed to prioritise walking and cycling along both footpaths and carriageways.   |

|      |   |
|------|---|
| C11. | <p>Mcllwaine Park must not receive any additional overshadowing from new development between 8.30am and 12.30pm on the Winter Solstice.</p> <p>Turfed area within Mcllwaine Park (<b>Figure K16-16</b>) must not receive any additional overshadowing from new development between 8.00am - 2.00pm on the Winter Solstice.</p> <p>Bray's Bay must not receive any additional overshadowing from new development between 8.30am and 12.30pm on the Winter Solstice.</p> <p>King George Reserve must not receive any additional overshadowing from new development between 8.30am and 12.30pm on the Winter Solstice.</p> <p>Uhrs Reserve must not receive any additional overshadowing from new development between 8.30am and 12.30pm on the Winter Solstice.</p> |
| C12. | <p>Open Space of the School Site must not receive any additional overshadowing from new development between 10.00am and 2.00pm on the Winter Solstice.</p> <p>Location of school's open space is to be determined through a detailed architectural design process.</p>  |
| C13. | <p>The Foreshore Park in Leeds Street Character Area must not receive any overshadowing from new development between 8.30am and 12.30pm in the Primary Zone on the Winter Solstice.</p> <p>The Foreshore Park must not receive more than 50% overshadowing from new development after 12.30pm on the Winter Solstice.</p>   |

**OPEN SPACE NETWORK**

-  Green Streets
-  Gateway Station Bridge
-  Mixed Use Corner
-  Existing Ecological Habitat
-  Public Open Space
-  River Activation
-  Ferry Wharf (proposed)
-  Land to which The DCP Applies

**Existing Open Space Network**

1. Mill Park
2. John Witton Bridge Park
3. Uhrs Reserve
4. King George V Reserve
5. McIlwaine Park
6. Brays Bay Reserve
7. Rhodes Park
8. Churchill Tucker Reserve
9. Leeds St Foreshore



Figure K16-16 Open space network plan



## Landscape Treatment and Urban Elements

The design of the public domain is to adhere to plans prepared by *City of Canada Bay*. Landscape design on private land needs to integrate with the design intention and treatment outlined in this document.

This will help to integrate new development into the streetscape, enhance the appearance and amenity of the area, provide for recreation, preserve biodiversity and improve micro-climatic conditions.

### Objectives

- O12 To promote high quality landscape design as an integral component of the overall design of new development.
- O13 To conserve and incorporate significant natural features, vegetation and native fauna and flora habitats.

### Controls

|      |   |
|------|---|
| C14. | Existing street trees and landscape features are retained wherever possible.  |
| C15. | Landscape design complements the proposed built form and minimises the impacts of scale, mass and bulk of the development in its context.   |
| C16. | Landscape design highlights architectural features, defines entry points, indicates direction, and frames and filters views from and into the site.   |
| C17. | Native species must comprise at least 50% of the plant schedule, incorporating a mix of locally indigenous trees, shrubs and groundcovers appropriate to the character of the area.   |
| C18. | The selection and location of vegetation and trees should: <ol style="list-style-type: none"> <li>Provide shade in summer and sun access in winter to building facades and public and private open spaces</li> <li>Reduce glare from hard surfaces</li> <li>Channel air currents into the building</li> <li>Provide windbreaks where desirable</li> <li>Screen noise and enhance visual privacy where desirable.</li> </ol> |

|      |   |
|------|---|
| C19. | Where suitable, landscape areas on the development sites are to be made publicly accessible to pedestrians unhindered by fencing or other structural barriers.  |
| C20. | All development is to provide places for residents to meet. This is to be in the form of a community notice board or room, shared laundry spaces, picnic tables and / or covered seating areas in landscaped surroundings.  |
| C21. | Mature tree canopies must achieve at least 25% site coverage as calculated cumulatively as private and public domain.   |
| C22. | A detailed landscape plan is to be provided as part of a Development Application to demonstrate how the street block of the subject development site will achieve 25% canopy cover at ground level, including within the development site.<br><br>Trees on building structures do not contribute to canopy cover under this control, and where relevant may be considered as contributing to the green view index requirements. |
| C23. | On site landscape replacement must be provided as the equivalent or more of the total site area. Landscape replacement can be provided through the following: <ul style="list-style-type: none"> <li>Vertical and facade greening;</li> <li>Rooftop greening and greening of communal podium spaces; and</li> <li>Public open space, through site links within the site boundary.</li> </ul>                                    |

|      |  |      |   |
|------|--|------|---|
| C24. | <p>All development must contribute to and demonstrate a 25% Green View Index using the methodology outlined in <b>Figure K16-17 to Figure K16-21</b> and described below.</p> <p>The Green View Index (GVI) is a numerical value given to the amount of green canopy and landscape perceived by an individual at street level. Tree canopies, understorey vegetation, and facade greening are the three primary contributors to the GVI.</p> <p>The GVI target for Station Gateway West (Precinct D) is 25%. To achieve this, the design of streets and new developments must include an objective assessment of the GVI value achieved, using the following method:</p> <ul style="list-style-type: none"> <li>Where tree canopies and understorey vegetation do not achieve the GVI target, facade greening is required to the extent necessary to achieve the minimum requirement.</li> </ul> | C28. | <p>Circulation paths must be a minimum of 2.4m in width and extend to a minimum of 80% of the depth of the space.</p> <p>Trees planted flush-to-grade, light poles, public space signage, and litter bins are permitted within circulation paths, however, 1.8m of continuous path must remain clear of fixed furniture elements at all times.</p> <p>Circulation paths must have a cross-fall no greater than 2.5%.</p>  |
| C25. | <p>Compliance with the green view index and urban tree canopy cover are not interchangeable, and must be considered as separate requirements.</p>  | C29. | <p>The following elements are prohibited from the public park / plaza / building interfaces, and if located adjacent to the public park / plaza, should be screened or concealed from view: Garage entrances, driveways, parking spaces, loading berths, exhaust vents, mechanical equipment, and building bin storage facilities.</p> <p>Vents and mechanical equipment are prohibited on any adjacent building walls within 5m of the level of the public park / plaza. Air intake vents and intake shafts, such as those to serve underground facilities, are permitted within the public domain if they are incorporated into design features and do not impair view lines.</p> |
| C26. | <p>All public space design must adhere to the Australian Standard Design for Access and Mobility (AS1428).</p>   | C30. | <p>Quality paving is required for all public domain areas.</p>  |
| C27. | <p>Public domain step risers must be no less than 100mm, and no greater than 150mm (exception can be made for vanishing steps).</p> <p>Seating steps shall be in the range of 150mm-500mm</p>  |      |   |

|      |  |      |  |
|------|--|------|--|
| C31. | <p>Seating requirements:</p> <p>At least 1 lineal metre of seating must be provided for every 30m<sup>2</sup> of public domain space along the foreshore and within parks and plazas.</p> <p>Movable seating for cafes may constitute up to 50% of the seating requirement, and may be stored outside of trading hours.</p> <p>Up to 50% of seating may be informal (e.g. low walls/seating steps).</p> <p>50% of formal seating is required to have backs and armrests.</p> <p>There are six types of seating that may be used to satisfy the seating requirements: moveable seating, fixed individual seats, fixed benches, seat walls, planter ledges, and seating steps.</p> | C34. | <p>Light levels should be uniform and be maintained at adequate levels for the use of the park. Lighting should be provided to all public open spaces and through site links in accordance with the principles of CPTED, Australian Standards, and Council requirements.</p> <p>Lighting should be considered in a hierarchy. Any pedestrian movement zone or area of circulation should be adequately illuminated to identify 'safe routes' for users. Areas not intended for night activity should not be lit with the same level of illumination as those that are.</p> <p>All lighting within the public domain must be shielded to avoid impacts on nearby residential units.</p> <p>Street lighting will be evenly spaced wherever possible. Distance from existing and new trees will be maximised to minimise conflict with canopies. Additional outreach of fittings and/or providing secondary luminaries for the pedestrian path may be appropriate to achieve both the required light levels and canopy cover.</p> |
| C32. | <p>Seating must be minimum 450mm depth, and in the height range of 400mm to 500mm.</p> <p>Seating provided on planter ledges are required to be at least 550mm deep.</p> <p>Seating steps can provide flexible seating – from simple perches to generous, amphitheater-style seating --and are permitted to range between 150mm and 500mm in height.</p>   | C35. | <p>Requirements for event power supply are to be as directed by council.</p> <p>All power supply points are to be thoughtfully located for convenience and to minimize visual clutter. Power supply must be located in lockable in-ground power boxes wherever possible.</p>   |
| C33. | <p>Deterrents to seating, such as spikes, rails, or deliberately uncomfortable materials or shapes, placed on any surfaces that would otherwise be suitable for seating are prohibited within public plazas.</p> <p>Devices incorporated into seating that are intended to prevent damage caused by skateboards are permitted. Such deterrents are required to be spaced at least 1.5m apart from one another, be constructed of high-quality materials that are integrated with the seating design, and must not inhibit seating.</p>   | C36. | <p>Public drinking fountains / water refill stations must be provided as directed by Council.</p> <p>The product selection and location must consider accessibility for all, including children and pets. The design must consider proximity to key areas such as the play space, amenities building, and ferry wharf.</p>   |

|      |   |      |   |
|------|---|------|---|
| C37. | <p>Bollards should only be included where it is necessary to discourage vehicle movement. They must not be perceived as a pedestrian barrier. They should only be used as an element of access control. Bollards are recommended where trafficable areas adjoin flush with public spaces (e.g. plazas, through site links).</p> <p>In alignment with best practice, a variety of bollards can be used. This includes bollards that contain planting, removable bollards, fixed bollards and bollards as seating elements.</p> | C41. | <p>To ensure a vibrant and visually appealing public space, consideration must be given to the treatment of adjoining walls and facades.</p> <p>Any building entry must be clear and legible. The entries must be unobstructed within 5m of entry.</p> <p>Walls required for planters or to mitigate changes in grade must not be visually or spatially intrusive on the space, and must be designed to a comfortable seating height wherever possible.</p> <p>Blank building walls or facades facing onto public space must be treated with public art or screened with vertical planting to a minimum height of 5m above the ground.</p>  |
| C38. | <p>Requirements for general waste and recycling bins are to be as directed by Council.</p> <p>All waste facilities are to be located within 15m of seating and gathering spaces. Visual appearance and impacts of smell should be carefully considered when locating waste facilities.</p>  | C42. | <p>Public art must be delivered in accordance with City of Canada Bay's Public Art Plan 2014.</p> <p>Public art gives people reason to stop and engage with the public domain. It can also celebrate cultural and environmental diversity and instill a sense of belonging.</p> <p>A site specific Public Arts Plan is to be prepared by an arts and cultural planner and will be required to address the following:</p> <ul style="list-style-type: none"> <li>Identify opportunities for the integration of public art in the proposed development;</li> <li>Identify themes for public art;</li> <li>Durability, robustness and longevity of the public art;</li> <li>Demonstrate how public art is incorporated in the site and built form design;</li> <li>Demonstrate that the scale of the public art is appropriate and proportionate to the development and thoughtfully sited &amp; integrated with the building to create a point of interest and define the location of area; and</li> <li>Provide a program for installation and integration with the construction program for the development.</li> </ul> |
| C39. | <p>All signage in public space must be visible and legible. Signage design (i.e. font, colour and shape) should be aligned with the greater public domain elements palette.</p> <p>Where appropriate, wayfinding and signage should integrate digital technologies, as outlined in the City of Canada Bay's Operational Plan 2019-2020.</p>   |      |   |
| C40. | <p>Public bicycle parking is required in accordance with the City of Canada Bay's standards, as outlined in the Development Control Plan (DCP).</p>   |      |   |





Figure K16-17 GVI: Small Tree Typical Option

- Small full canopy trees spaced at 5m centres
- Understorey planting at base of tree (understorey planting at 0.6m high)
- Extensive facade greening



Figure K16-21 GVI: Medium Tree Typical Option

- Medium trees spaced at 8m centres
- Understorey planting at base of tree (understorey planting at 0.6m high)
- Medium facade greening



Figure K16-18 GVI: Large Tree Typical Option

- Large Tree spaced at 10m centres
- Understorey planting at base of tree (understorey planting at 0.6m high)



Figure K16-19 GVI: Double Row Trees Typical View

- Medium foreground trees spaced at 8m centres
- Understorey planting at base of tree (understorey planting at 0.6m high)
- Possible where there is widened verge or open space to the streetscape



Figure K16-20 GVI: Medium Tree Typical Option for Plazas and Parks

- Medium foreground trees spaced at 3-5 m centres for plazas and parks.

## Heritage landscape

Most heritage landscape elements in the Rhodes East Precinct are located on public land, however, new development can impact on their heritage value.

### Objectives

- O14 To ensure that new development does not impact on the heritage value or threaten the retention of the landscape elements, i.e. provision of vehicular access, methods of construction, future runoff or overshadowing impacts.
- O15 To ensure that contributory landscape elements are retained and conserved to the greatest extent possible.

### Controls

|      |  |
|------|--|
| C43. | New development must not threaten the retention and impact on the heritage value of the following items: <ul style="list-style-type: none"> <li>i) heritage listed reserves of Uhrs Reserve, King George Park and Mcllwaine Park</li> <li>ii) indigenous planting in Mcllwaine Park</li> <li>iii) heritage listed street trees on Cavell Avenue</li> <li>iv) remnant trees at the northern part of 4A Cavell Avenue (incorporated into future development).</li> </ul> |
| C44. | Where trees are missing from the established planting rhythm or are in poor health, they should be replanted to create a substantial streetscape character and public benefit in keeping with the existing character.  |
| C45. | Other significant landscape elements which are not heritage listed should be individually assessed for their contributory value if threatened.   |

## Integration of art

Permanent public art and art on private land visible from the public domain is to be integrated throughout the Precinct and may include sculptural art, lighting, typography, facade treatments and interactive art.

### Objectives

- O16 To provide opportunities to celebrate local history and culture and foster community dialogue.
- O17 To enhance a sense of place and support the values of the Character Areas and the Rhodes East Precinct as a whole.

### Controls

|      |   |
|------|---|
| C46. | New artwork should be integrated throughout the Precinct and on both public and private land, e.g. corner plazas, parks, reserves, the foreshore, built form facades, and within setbacks and foyers.   |
| C47. | New artwork reflects the principles, themes and opportunities as outlined in the <i>City of Canada Bay Rhodes Peninsula Art Plan</i> .  |
| C48. | New development above 4 storeys are to allocate 0.5% of the capital cost of development towards artwork. This art can either be provided/ integrated on the site of the development or paid as contribution to Council's public art fund.<br><br>Art integrated on site must be visible from the public domain and be permanent with a lifespan of 30+ years. |

## K16.5 Public-private interface

### Street and upper level setbacks

The proposed front setbacks have been identified to provide appropriate outcomes for the designated function, land use and intended character of the street. Upper level setbacks seek to lessen the visual impact of taller development and create a unified, human-scale streetscape environment.

#### Objectives

- O1 To respect and enhance the existing streetscape presence and character of the Precinct.
- O2 To facilitate a sensitive transition from existing built form to future development.
- O3 To enhance development and its relationship with adjoining sites and the public domain, particularly access to sunlight, outlook, view sharing, ventilation and privacy.
- O4 To provide a sense of enclosure to the street and contribute to the Precinct’s desired human-scale character.

| Controls |  |
|----------|--|
| C1.      | Street setbacks and upper level setbacks are as per <b>Figure K16-22</b> and <b>Figure K16-23</b> with the exception of development of or within the vicinity of heritage items. Refer to <i>Section K16.6 (Heritage items subheading)</i> of this DCP.                            |
| C2.      | The setback between the property boundary and the building line is to be landscaped, with a minimum 50% of the setback area to be deep soil.   |
| C3.      | Fencing is a maximum of 1.2m in height and at least 50% transparent.   |
| C4.      | Ground floors with ‘vibrant’ uses such as retail, commercial or cafes/ restaurants address the public space, are occupied by uses that contribute to pedestrian activity and are easily accessible at grade. Refer to <i>Section K16.5 (Façade design subheading)</i> of this DCP. |

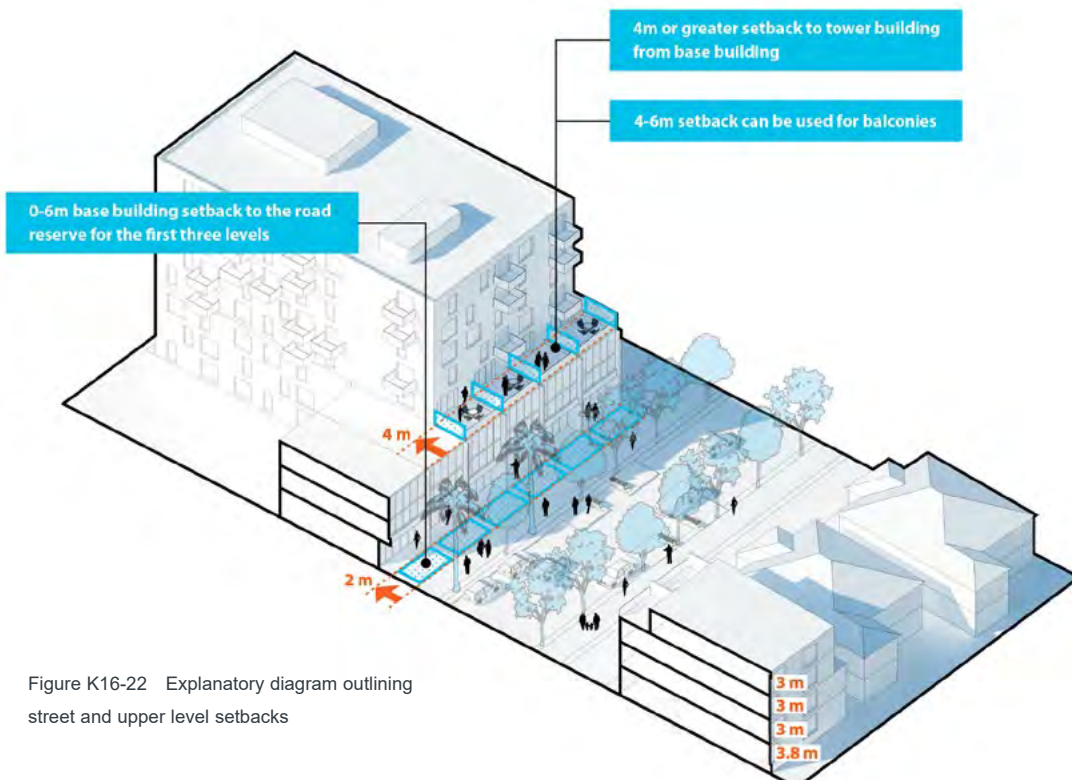

Figure K16-22 Explanatory diagram outlining street and upper level setbacks



Figure K16-23 Street and upper level setbacks plan



**Primary and secondary streets**

Primary Streets are important pedestrian connections and should be the principal address for any new development with particular emphasis on a high quality interface to the public domain and appropriate built form scale.

A significant portion of Primary Street frontages is envisaged to consist of terraces and multi-unit terrace apartments to achieve a safe and animated streetscape environment, while Secondary Streets will allow for vehicle access points and shared residential lobby entries.

**Objectives**

- O5 To create a public domain that supports and encourages pedestrian movement through activated streets and human-scale development fronting onto a defined hierarchy of streets.
- O6 To support the concept of a fine grain, vibrant streetscape experience whilst ensuring that a viable built form siting and access solution can be achieved.
- O7 To promote streetscape legibility along key pedestrian desire lines.

- O8 To facilitate street tree planting and landscaping along priority pedestrian streets (uninterrupted by driveway crossovers) to provide shade and amenity.
- O9 To promote passive surveillance on primary and secondary streets whilst balancing the practical requirement for access and servicing on secondary streets.

| Controls |   |
|----------|---|
| C5.      | Primary and Secondary Streets are to be delivered as per <b>Figure K16-25</b> .   |
| C6.      | Multi-dwelling housing (terraces and multi-unit terrace apartments) that address the street is required along 85% of any Primary Street frontage and along 60% of any Secondary Street frontage.<br><br>(Buildings north of Leeds Street and within the Station Gateway East Character Area are exempt from this control in order to enable large floorplate non-residential uses). |
| C7.      | Vehicular access points are not permitted along Primary Streets unless a development has no Secondary Street frontage.  |
| C8.      | 'Undesirable' elements along Primary Streets such as vents, electric substations, or plant and equipment spaces should not be located within the setback area.  |

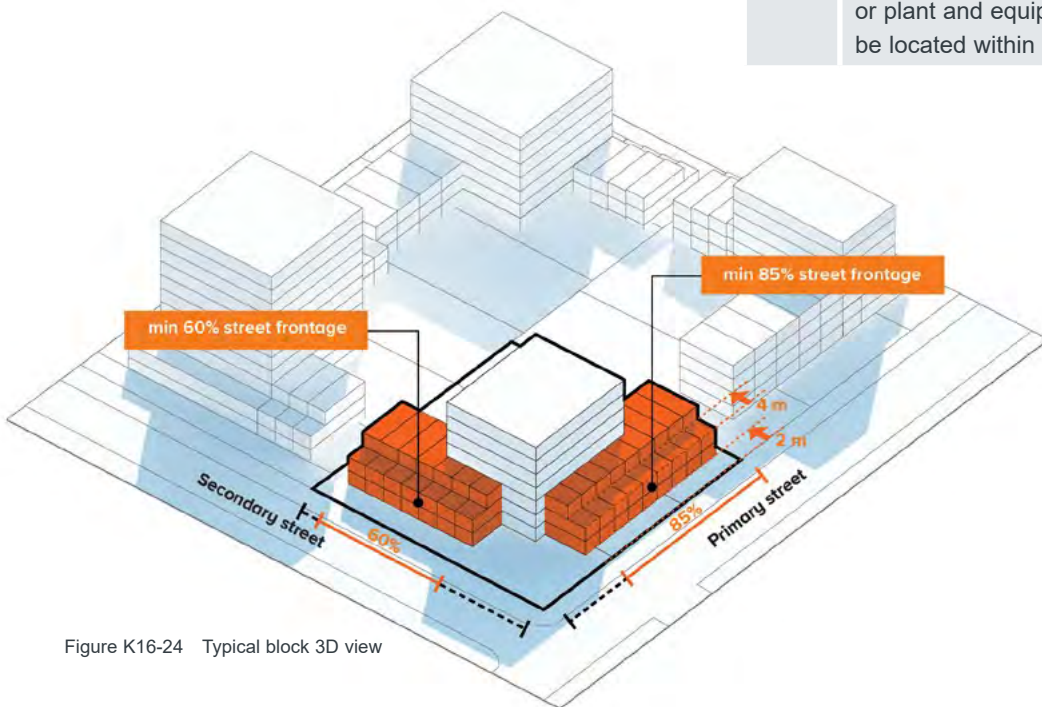

Figure K16-24 Typical block 3D view



Figure K16-25 Primary and secondary frontages



### Facade design

New development can fall into one of the three facade categories identified: 'Vibrant' facades, 'Friendly' facades or 'Mixed' facades. These categories are based on the intended function and pedestrian priority of the public space they address. For example, Vibrant facades are located along key desire lines and provisions for this category are more detailed than those that apply to the other two categories.

### Objectives

- O10 To support pedestrian activity by ensuring a high level of interest and facade design quality addressing the public domain.
- O11 To maximise the number of building entries that clearly address the street.



Example of a 'vibrant' facade



Example of a 'friendly' facade



Example of a 'mixed' facade

| Controls |   |
|----------|---|
| C9.      | Facade categories that apply to new development are as per <b>Figure K16-26</b> .   |
| C10.     | The maximum length of a straight wall, without articulation such as a balcony or return, is 8m.   |
| C11.     | <p>'Vibrant' facades are to deliver:</p> <ul style="list-style-type: none"> <li>• Small (narrow) units with a minimum of 15 front doors per 100m facade length</li> <li>• Ability to cater for a wide variety of uses such as shops, cafes, restaurants, bars, fruit/ vegetable markets, community uses and live-work units</li> <li>• A high degree of visual richness in facade details and architectural expression with a focus on vertical facade articulation, 'ins and outs' (recesses and projections to create shadows)</li> <li>• Vehicle access and servicing zones are not permitted</li> <li>• Signage is integrated into the overall architectural design.</li> </ul> |
| C12.     | <p>'Friendly' facades are to deliver:</p> <ul style="list-style-type: none"> <li>• Relatively small (narrow) units with a minimum of 10 front doors per 100m facade length</li> <li>• Ability to cater for some variety of uses such as shops and live-work units, including residential lobbies</li> <li>• Some degree of visual richness in facade details and architectural expression</li> <li>• Limited vehicle access and servicing via tight, recessed openings is permitted</li> <li>• Signage is integrated into the overall architectural design.</li> </ul>  |
| C13.     | <p>'Mixed' facades are to deliver:</p> <ul style="list-style-type: none"> <li>• A minimum of 6 front doors per 100m facade length</li> <li>• Blank facades over 10% of facade or 10m<sup>2</sup> are required to be of visual interest, i.e. by architectural treatment, detailing, art or greenery/ green walls</li> <li>• Signage is integrated into the overall architectural design.</li> </ul>   |



Figure K16-26 Public domain interface plan





## K16.6 Built form, diversity and use

### Built form strategy in the Cavell Avenue Character Area

The built form strategy in the Cavell Avenue Character Area seeks to deliver quality density and is based on a 'high-low' model, where taller buildings and towers are mixed with low to mid rise development such as terraces, terrace-style apartments and/ or walk-up apartments (typically 2-3 storeys). This desired built form outcome achieves a number of benefits, including:

- the mix and transition of height limits the impact on the amenity of existing lower scale residential areas, including overshadowing or loss of views;
- the mix of housing form creates a stimulating interface to the street and a human-scale environment, which supports pedestrian activity.

The maximum heights identified on the Local Environmental Plan map '*Height of Building*' illustrates the maximum height achievable on a site.

A requirement included in the Local Environmental Plan is for multi-dwelling typologies to be provided as part of all development which addresses primary and secondary street frontages (see *Section K16.5 - Primary and secondary streets subheading*). It is therefore not possible for the maximum height to be achieved across the entirety of any site.

The preferred outcome for development sites is a '*high plus low*' built form outcome, which is achieved when the height limit is only fully realised on part of the site in order to comply with the maximum FSR constraints.

This typically occurs when a development comprises a single taller element to optimise views and/ or minimise solar impact on communal open space and key public open spaces. The developer benefits from a height limit that allows a strategically located taller element, whilst the public domain is protected from the impact of a more consistent bulk and mass.

The alternate option is a '*low to medium*' built form outcome which maximises the FSR with none of the buildings reaching the maximum height. The FSR is evenly spread across the development site to form a consistent height envelope.



Examples of the desired 'high-low' built form outcome



### Tower and Podium Design

The Rhodes Planned Precinct builds on the ADG to provide a location-specific recommendation that gives equal priority to the public realm and experience as to that of the private open spaces and residences.

Therefore, additional floorplate controls, building separation and a height transition strategy are implemented (in excess of ADG at certain heights).

#### Objectives

- O1 To minimise overshadowing and wind impacts to co-located open spaces and public domain
- O2 To minimise loss of sky views and enable equitable view sharing
- O3 To allow for the passage of natural light and reduce "wall of buildings" from key public spaces.

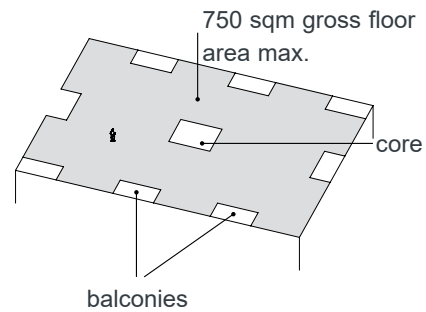

(Above) Maximum gross floor area of 750 square metres

#### Controls

|     |  |
|-----|--|
| C1. | Consistent with the Objectives and supplementing SEPP 65, building-to-building setbacks within the Precinct are to achieve the following separation controls:<br>15 - 20 storeys - 24m<br>Above 20 storeys - 40m   |
| C2. | Residential towers above podium level shall have a maximum gross floor area of 750 square metres.  |
| C3. | Towers above 20 storeys are to provide a 5 storey differential in building height from all adjacent towers.  |
| C4. | A minimum podium height of approximately 14-16m building height is required.   |
| C3. | A tower and podium building typology is required, subject to the following outcomes:<br><br>a) A ground floor setback of 3m is to be provided.<br>b) A Podium to Tower setback of 4m is to be provided.<br>c) Maximum 1/3 of a tower frontage along a street or public space can be extended down to the ground.<br><br>Public gathering areas must be associated with the 2/3 of the façade that is grounded by a podium. |

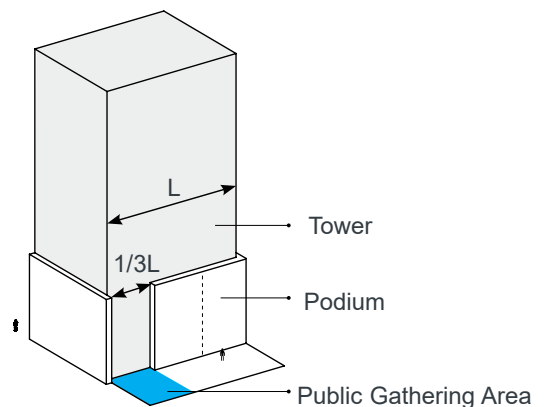
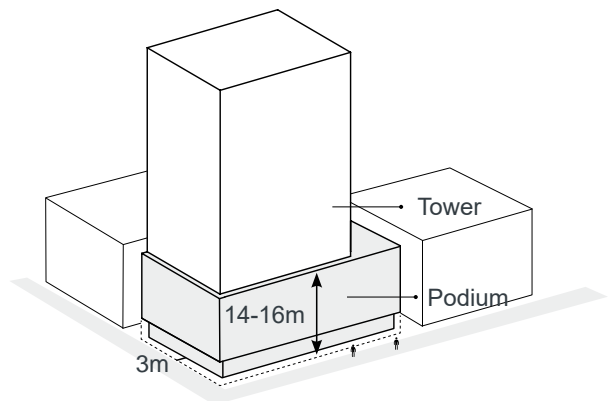



*Examples of the desired built form outcome incorporating tower design controls*

## Floor to ceiling heights

Floor to ceiling heights are directly linked to the potential use of a building, and the level of natural ventilation and daylight access. The ground floor levels of all new development in Rhodes East should have increased ceiling heights to ensure good internal amenity and long term adaptability.

### Objectives

- O4 To create resilient urban places by ensuring buildings, in particular at ground floor, are flexible and adaptable over time to a wide range of uses and changing demands.

### Controls

C5. Development is to be consistent with the following minimum floor to ceiling heights:

| Use                   | Min. height (m) |
|-----------------------|-----------------|
| Retail/ commercial    | 3.6m            |
| Community             | 3.3m            |
| Residential/ terraces | 3.1m            |
| Above ground parking  | not permitted   |

C6. The minimum floor to ceiling height of all ground floors is to comply with the category of 'Retail/ commercial' in the above table.

C7. The finished floor level of the ground floor above the footpath level is to be no greater than 1.0 metres for residential uses and 0.4 metres for retail and commercial uses.

## Residential uses not covered by the Apartment Design Guide

The NSW Apartment Design Guide (ADG) applies buildings that are three or more storeys high and that comprise at least four dwellings. For other residential development types, such as 2-3 storey terraces, low rise up-over or walk-up apartments, multiplexes, urban courtyard houses and the like, the following controls apply.

### Objectives

- O5 To ensure design quality, performance of and amenity created by new residential development is of a high standard and consistent across the Precinct.

### Controls

C8. The maximum building depth is 18 metres unless it can be demonstrated that all habitable rooms receive adequate ventilation and solar access, e.g. through the use of a courtyard design.

C9. The minimum private open space of a ground floor dwelling is calculated by the number of bedrooms x 4m<sup>2</sup>.

C10. Single aspect dwellings, if unavoidable, are only permitted if they have a northerly or easterly aspect.

C11. Parking is not permitted to be visible from streets and open spaces. Access to parking via a driveway, lane or basement carpark entry is permitted if one access point services a minimum of 5 dwellings. Front garages, carports and individual driveways are strictly not permitted.

C12. At least 70% of living rooms and private open spaces of a dwelling receive a minimum of 2 hours direct sunlight between 9 am and 3 pm at mid winter.

C13. Master bedrooms have a minimum area of 10m<sup>2</sup> and other bedrooms 9m<sup>2</sup>.

C14. Building separation is as per the *Apartment Design Guide, Section 3F Visual Privacy*.

## Affordable housing

Affordable housing means rented housing occupied by households on very low, low or moderate incomes. For Rhodes East, there is a requirement to provide a proportion of affordable dwellings as specified in the Canada Bay Affordable Housing Contribution Scheme.

### Objectives

- O6 To ensure that low to moderate income households can afford to live in Rhodes East by increasing the stock of appropriate affordable housing.

### Controls

|      |  |
|------|--|
| C15. | A minimum of 5% total gross floor area is dedicated as affordable housing in the areas identified in <b>Figure K16-27</b> .    |
| C16. | Dwellings dedicated to affordable housing are to be of equivalent design quality, diversity and mix as all other dwellings.    |
| C17. | Affordable housing is to be consistent with the requirements of the <i>Canada Bay Affordable Housing Contribution Scheme</i> . |



Figure K16-27 Affordable housing plan



## Materials, finishes and colours

The selection and choice of materials, finishes and colours should have regard to robustness, durability, energy performance and compatibility to the surrounds.

### Objectives

- O7 To ensure building exteriors positively contribute to the desired future character of the area and streetscape.

| Controls |   |
|----------|---|
| C18.     | The composition of facades balances solid and void elements and does not display large areas of a single material, including reflective glass.  |
| C19.     | External walls are constructed of high quality and durable materials and finishes with low maintenance attributes such as face brickwork, rendered brickwork, stone, concrete and/or glass. |
| C20.     | Sidewalls are designed as an architecturally finished surface that complements the main building facade.  |
| C21.     | Visually prominent elements such as balconies, overhangs, awnings, and roof tops are to be of high design quality.  |
| C22.     | Roof plant, lift overruns, utilities, vents and other service related elements are to be integrated into the built form design and complementary to the architecture of the building.       |
| C23.     | Facades reinforce the vertical proportions and support a vertical rhythm along the street.  |
| C24.     | Adjoining buildings are considered in terms of setbacks, awnings, parapets, cornice lines, selection of materials and finishes, and facade proportions.                                     |
| C25.     | Design to be approved by the City of Canada Bay Design Review Panel.  |

## Heritage items





A number of local heritage items are situated within the Precinct, shown in **Figure K16-28** and listed in the LEP. This section outlines provisions for adaptive reuse of and development in the vicinity of selected heritage items in addition to the provisions contained in the Heritage controls in the *Canada Bay DCP*.

### Objectives

- O8 To protect buildings, spaces and streetscapes of heritage significance within and in the vicinity of the Precinct.
- O9 To ensure that new development responds sensitively to the heritage significance of each listed item and does not physically overwhelm or dominate a heritage item or impact on its setting.

| Controls |  |
|----------|--|
| C26.     | All development of and in the vicinity of a heritage item is to address the requirements of the Heritage controls in the <i>Canada Bay DCP</i> .   |
| C27.     | New development provides appropriate transitions to existing buildings, structures and streetscapes of heritage value.   |
| C28.     | New development uses sympathetic materials, colours and finishes that reflect and harmonise with original materials to maintain the character of heritage items and contributory buildings.  |
| C29.     | Whilst not formally heritage listed, the Coptic Church on Cavell Avenue has a strong historical association with the Community. If it is to be retained in situ then the setting and orientation of the building is to be respected. |
| C30.     | The Canada Bay Local Environmental Plan sets out building setback controls for sites adjacent to Heritage Items.   |

**HERITAGE**

-  Heritage Item
-  Non Listed Community Item\*
-  Ferry Wharf (proposed)
-  Land to which the DCP applies

**Listed Heritage Items**

1. 59 Blaxland Road - Individual House
2. 63 Blaxland Road - Former School Building
3. 4A Cavell Avenue - Concord Community Hostel - grounds only
4. 14 Cavell Avenue - Warehouse
5. 35 Cavell Avenue - Individual House
6. Cavell Avenue Street Trees
7. McIlwaine Park
8. Uhrs Point Reserve
9. Rhodes Station



Figure K16-28 Heritage items plan

\*The Coptic Church has a strong historical association with the community and is to be retained in situ.





There are a number of heritage items within the Rhodes East Precinct for which specific development controls apply as follows:

### 59 Blaxland Road

| Controls |  |
|----------|--|
| C31.     | The existing Federation period house to remain in situ and be retained as residential or incorporate a complimentary change of use.  |
| C32.     | The two palm trees in the front garden are to be either retained or relocated within the current site.   |
| C33.     | The paved court at the rear can be redeveloped with a low scale building.  |
| C34.     | The existing front lawn presentation to the north of the house is to be retained.  |
| C35.     | Adjacent development to the south is to be set back by a minimum of two metres from the common boundary for the first two storeys before a further setback of four metres from three to eight storeys. |
| C36.     | Street setbacks of adjacent development are to match the prevailing front setbacks.  |

### 63 Blaxland Road

| Controls |  |
|----------|--|
| C37.     | The former school building is to be retained in-situ for community use or compatible change of use.                |
| C38.     | Existing trees, particularly those to the north, are to be retained.   |
| C39.     | The paved areas can be re-used or landscaped for pedestrian amenity.   |
| C40.     | The historic core of the school building is to be conserved and revealed by the demolition of the later enclosure. |
| C41.     | No vertical additions will be permitted to the retained school building.   |

### 4a Cavell Avenue

| Controls |   |
|----------|---|
| C42.     | The existing heritage listed trees are to be retained and incorporated into any redevelopment of the northern part of the site. |
| C43.     | The land to the south of the listed trees can be redeveloped subject to the relevant controls.                                  |

### 14 Cavell Avenue

| Controls |  |
|----------|--|
| C44.     | Existing face brick to be retained and incorporated into any new development at the rear or on adjoining sites.  |
| C45.     | New development at the rear can abut the existing brick building, with the first saw tooth roofed portion retained at the same height as the brick building. |
| C46.     | Adjoining sites may be redeveloped with zero lot boundary separations but must apply a front setback consistent with the heritage building.                  |

### 35 Cavell Avenue

| Controls |   |
|----------|---|
| C47.     | The existing Federation period house is to remain in situ and be retained as residential or incorporate a complimentary change of use.  |
| C48.     | Adjacent development is to be set back by a minimum of two metres from the common boundary for the first two storeys before a further setback of six metres from the boundary for three to eight storeys. |
| C49.     | Street setbacks of adjacent development are to match the prevailing front setbacks.   |



Above: Artist impressions of the desired future look and feel of Rhodes East Precinct

## K16.7 Access and parking

### Bicycle parking and facilities

The provision of bicycle facilities and parking is required in all new developments.

#### Objectives

- O1 To encourage cycling as a highly convenient transport mode by providing easily accessible and secure parking and end-of-trip facilities.
- O2 To reduce car-usage and reliance, promote sustainability and a more active, healthy lifestyle.

#### Controls

|     |  |
|-----|--|
| C1. | Secure, conveniently located bicycle parking is to be incorporated in all new development at the rates specified in <b>Table K16-3</b> .   |
| C2. | End of trip facilities (showers, lockers) are provided for all new development with more than 5 employees.   |
| C3. | Secure bike parking facilities are to be provided in accordance with the following: <ul style="list-style-type: none"> <li>a) Class 1 bike lockers for occupants of residential buildings;</li> <li>b) Class 2 bike facilities for staff/employees of any land use; and</li> <li>c) Class 3 bike rails for visitors of any land use</li> </ul> |
| C4. | Where bike parking for residents is provided in a basement, it is to be located: <ul style="list-style-type: none"> <li>a) on the uppermost level of the basement;</li> <li>b) close to entry/exit points; and</li> <li>c) subject to security camera surveillance where such security systems exist.</li> </ul>                               |
| C5. | A safe path of travel from bike parking areas to entry/exit points is to be marked.  |
| C6. | Bike parking for visitors is to be provided in an accessible on-grade location near a major public entrance to the development and is to be signposted.  |

**Table K16-3 Minimum bicycle parking provision**

| Land Use    | Resident/ staff                           | Visitor                                 |
|-------------|---|---|
| Residential | 2 per dwelling within 400m of the station | 2 per 10 dwellings                      |
| Commercial  | 2 per 150m <sup>2</sup> GFA               | 2 per 400m <sup>2</sup> GFA             |
| Retail      | 2per 250m <sup>2</sup> GFA                | 4 per unit +2 per 100m <sup>2</sup> GFA |
| Industrial  | 2 per 10 employees                        | 4 per unit +2 per 100m <sup>2</sup> GFA |

### Car parking design

Car parking needs to be accessible and convenient. It should also be designed so that it does not detract from the amenity of the streetscape.

This DCP prescribes maximum car parking rates (as opposed to minimum requirements) for all new development. These rates are based on the proximity of the development to the train station and supplemented by car share car parking provision and increased minimum bicycle parking rates.

#### Objectives

- O3 To ensure off street car parking has a minimum impact on the quality of the streetscape.
- O4 To future-proof development in anticipation of reduced private vehicle reliance.
- O5 To strengthen pedestrian safety by minimising conflict points and ensuring good sight-lines.
- O6 To maximise retail, community and residential street frontage uses.
- O7 To encourage the use of alternative types of transport, including active transport (walking, cycling), the use of public transport and car sharing schemes.
- O8 To assist with housing affordability and flexibility of ownership by decoupling car parking from the dwelling.

| Controls |   |
|----------|---|
| C7.      | Car parking is to be located at the rear of buildings or within a basement car parking structure.   |
| C8.      | The outer perimeter of the basement is to be behind the setback.  |
| C9.      | Garages and parking structures are not to project forward of the building line and are to be screened from the public domain by active uses.  |
| C10.     | Vehicular access ways are designed to be integrated with the building and preferably with single entry/ exit lane. The width and number of vehicle access points should be limited to the minimum |
| C11.     | All residential car parking is to be decoupled through separate titles. The transfer of car space ownership is encouraged within the precinct.  |
| C12.     | Car parking spaces are to be provided at the rates specified in <b>Table K16-4</b> and shown in <b>Figure K16-24</b> .  |
| C13.     | Where car parking spaces are provided for car share schemes, these are to be provided in lieu of the maximum car parking rates in accordance with the figures in <b>Table K16-5</b> .             |
| C14.     | Electric vehicle charging stations are to be provided as per <b>Table K16-6</b> .   |
| C15.     | For any use not specified in <b>Table K16-6</b> rates in the <i>City of Canada Bay Development Control Plan</i> apply.  |
| C16.     | Parking is to comply with the requirements of E3.9 of the <i>City of Canada Bay Development Control Plan</i> except for an inconsistency with this Section.                                       |
| C17.     | Motorcycle parking is to be provided as set out in <b>Table K16-7</b> .   |

## Car share

| Controls |   |
|----------|---|
| C18.     | Car share spaces are encouraged within all new developments. Car share spaces are to be for the exclusive use of car share scheme vehicles and provided as per the standings in <b>Table K16-5</b> .  |
| C19.     | Car share parking spaces are to be: <ul style="list-style-type: none"> <li>• Provided as set out in <b>Table K16-5</b></li> <li>• Exclusive of visitor car parking</li> <li>• Retained as common property of the Owners Corporation of the site and not sold or leased to an individual owner/ occupier at any time</li> <li>• Made available for use by operators of car share schemes</li> <li>• Grouped together in the most convenient locations relative to car parking entrances and pedestrian lifts or access points</li> <li>• Located in well-lit places that allow for casual surveillance</li> <li>• Signposted for use only by car share vehicles; and made known to building occupants and car share members through appropriate signage which indicate the availability of the scheme and promotes its use as an alternative mode of transport.</li> </ul> |
| C20.     | Development Applications are to demonstrate how the car share parking space(s) is to be accessed, including where access is through a security gate. A covenant is to be registered with the strata plan advising of any car share parking space. The covenant is to include provisions that the car share parking space(s) cannot be revoked or modified without prior approval of Council.  |

**Table K16-4 Maximum car parking rates**

| Land Use              |  |
|-----------------------|--|
| Residential           | 0.1 spaces per studio dwelling, and<br>0.3 spaces per dwelling with 1 bedroom,<br>0.7 spaces per dwelling with 2 bedrooms, and<br>1 space per dwelling with 3 or more bedrooms, and<br>1 visitor car parking space per 20 dwellings.<br><br>If the total number of car parking spaces under this clause is not a whole number, the total is to be rounded down to the next whole number. |
| Commercial            | 1 space per 150m <sup>2</sup> GFA  |
| Retail                | 1 space per 100m <sup>2</sup> GFA  |
| Cafes and restaurants | 1 space for 150m <sup>2</sup> GFA  |

**Table K16-5 Car share rates**

| Land Use                                       | Within 400m of station | Outside 400m of station                                   |
|--|------------------------|---|
| Residential                                    | 1 per 20 dwellings     | 1 per 40 dwellings  |
| Car share rate to reduce car parking provision | N/A                    | 1 car share space in lieu of 3 private car parking spaces |

**Table K16-6 Minimum electric vehicle charging stations**

| Type of charging facility   | Minimum number of charging facilities/stations   |
|---|--|
| Level 1 <ul style="list-style-type: none"> <li>Regular 240V wall socket (10 amps)</li> <li>No specialist installation required</li> <li>16-20 hours to fully charge average vehicle</li> </ul>  | 1 per parking space<br><br>1 per five bicycle parking spaces (a dedicated space and charging point for electric bicycles and mobility scooters to be charged must be provided for every five bicycle parking spaces) |
| Level 2 AC <ul style="list-style-type: none"> <li>Directly wired into a dedicated circuit (16 amp - 40 amp)</li> <li>Level 2 provides between 18 km to 110 km of charge per hour</li> <li>Total charge time of between 4 - 12 hours depending on the vehicle</li> </ul> | 1 shared facility for developments with 5 - 10 dwellings<br><br>And 1 additional shared facility for every additional 10 dwellings or part thereof<br><br>To be provided in common or visitor parking areas          |

**Table K16-7 Motorcycle rates**

| Land Use    |                    |
|-------------|--------------------|
| Residential | 2 per 10 dwellings |

## K16.8 Environmental resilience

### Sustainable Utility Infrastructure

The provisions in this part apply to all developments that require new or upgraded utility connections. The aim is to improve the environmental performance and future resilience of the Rhodes East area through the use of district infrastructure that supplies low carbon and/or renewable electricity and water recycling.

All developments to which this part applies shall make provisions for:

- Private Wire Network connection
- On-site Solar Photovoltaic installation
- Recycled Water Network connection
- Private Sewer Network connection
- Green Roofs

#### Private Wire Network

**Objective:** The objective of the Private Wire Network is to futureproof the Precinct, enable renewable energy installation and reduce the operating costs of the Precinct.

A Private Wire Network permits the distribution of electricity between individual dwellings or buildings and is intended to facilitate and distribute onsite renewable electricity installations as well as potential future battery storage.

The Private Wire Network is intended to supplement and/or replace the conventional electrical networks. It is intended that a nominated operator will be granted an easement within council owned lands and streets for the purposes of operating the Private Network.

#### Controls

|     |   |
|-----|---|
| C1. | All developments requiring new or upgraded electricity connections shall grant an easement in favour of the council or its nominated operator from the site street boundary to the roof of the building for the purposes of electricity transmission. Council or its nominated operator shall be granted access to this easement. |
| C2. | All easements in ground shall be dedicated for the sole purpose of electricity transmission and not shared with other utilities. In ground easements shall be no less than 1m wide.   |
| C3. | Any easements within buildings shall be in the form of an accessible conduit or riser sized sufficiently to carry no less than the peak load of the building and/or any on site generation or storage.  |
| C4. | All switchboards, metering and circuits shall be designed for not less than 400V 3 phase connection in accordance with the greater of a. applicable Australian Standards or b. Supplier of last resort standards.   |
| C5. | All developments shall make an Application for Connection Requirements with respect to the private wire network to the council or its nominated operator prior to submitting a development application.   |

### On-site Solar Photovoltaic

**Objective:** To reduce the overall carbon footprint of Rhodes East, increase resilience and reduce operating costs of the Rhodes East Precinct.

| Controls |   |
|----------|---|
| C6.      | All developments which require new or upgraded utility connection shall grant an easement in favour of council or its nominate solar provider for the installation of Solar Photovoltaic panels not less than 50% of the area of roof area. |
| C7.      | Any easement granted shall not be overshadowed by buildings or trees within the same property.  |
| C8.      | The easement shall permit access to the roof by council or its nominated solar provider for the purposes of installation, maintenance or operation.   |
| C9.      | All roof structure subject to the easement shall be designed to structurally accept photovoltaic panels.  |
| C10.     | An internal dedicated space shall be provided within 10m of the solar easement. The space shall be not less than 2.5m by 2.5m and 2.8m in height.   |

### Precinct Private Wire Network

**Objective:** Each development shall be capable of connecting to the Precinct Private Wire Network. The Precinct Private Wire Network will enable the distribution and metering of electrical production from the Solar Photovoltaic systems and conventional electrical distribution to developments.

| Controls |  |
|----------|--|
| C11.     | The Precinct Private Wire Network is to be operated by the council or its nominated operator.  |
| C12.     | The Precinct Private Wire Network shall be operational prior to the connection of the first development.   |
| C13.     | The Precinct Private Wire Network will have a gate metering system at the connection point to the public electrical system.  |
| C14.     | A nominal 1 m wide continuous easement will be established by council in the public domain, for the purposes of reticulation within the Precinct Private Wire Network.   |
| C15.     | Precinct Private Wire Network infrastructure easements located within the public domain shall be designed in accordance with Ausgrid standards. Variations in the easement to accommodate the standards in public domain will be coordinated by council as required. |



## Recycled Water Network

**Objective:** To provide recycled water to all buildings and the public domain and ensure sufficient demand and scale to support efficient and economic recycled water plant. The recycled water network will reduce potable water demand within the Precinct, reduce upstream and downstream infrastructure impacts and increase resilience and drought-proofing.

### Controls

|      |   |
|------|---|
| C16. | All new buildings shall be provided with a suitably sized purple pipe recycled water reticulation to all non-potable fittings and fixtures including as a minimum all irrigation locations and toilets.                             |
| C17. | All new buildings shall provide a connection point and meter location at the site boundary for recycled water.  |
| C18. | All developments shall make an Application for Connection Requirements with respect to the recycled water network and private sewer network to the council or its nominated operator prior to submitting a development application. |

## Private Sewer Network

**Objective:** To provide a source for recycled water production to enable provision of recycled water to all buildings, the public domain within Rhodes East as well as buildings and parks in surrounding precincts.

### Controls

|      |   |
|------|---|
| C19. | All developments shall make an Application for Connection Requirements with respect to the recycled water network and private sewer network to the council or its nominated operator prior to submitting a development application. |
|------|---|

### Precinct Recycled Water and Private Sewer

**Objective:** Each development shall be capable of connecting to the Precinct Recycled Water and Private Sewer Networks. The Precinct Private Sewer Network will provide feedstock to the Recycled Water plant for Recycled Water production.

| Controls |   |
|----------|---|
| C20.     | The Recycled Water plant shall be operated by the council or its nominated operator.  |
| C21.     | The Recycled water plant and associated reticulation must be operational prior to the connection of the first development.  |
| C22.     | The Recycled water plant shall be located in the basement area a new development within either the Station Gateway East Character Area or the Leeds Street Character Area Character Area.   |
| C23.     | An easement for an 1,800 m x 5 m (digestion tanks borne below slab grade) Recycled Water plant shall be constructed at the lowest area of the Precinct.   |
| C24.     | A nominal 1 m wide continuous easement will be established by council in the public domain, for the purposes of reticulation within the Recycled Water and Private Sewer networks.  |
| C25.     | Precinct Recycled Water and Private Sewer network infrastructures easements located within the public domain shall be designed in accordance with the Water Industry Competition Act 2006. Variations in the easement to accommodate the standards in public domain will be coordinated by council as required. |

### Green Roofs

**Objective:** to maximise the opportunity to provide rooftop space as passive and active open space.

| Controls |   |
|----------|---|
| C26.     | Communal roof tops are to be provided on all buildings for passive and active open space, such as fenced ball-courts, BBQ area and low maintenance gardens. |
| C27.     | Roof tops are to be structurally sound and have the capacity of supporting deep soil planting on at least 30% of the rooftop space.                         |
| C28.     | Rooftop spaces are to be shared with solar photovoltaic panels connected to the precinct solar network wire grid.   |
| C29.     | Rooftops are to incorporate wind shielding design to provide user comfort.  |



Figure K16-29 Special projects location plan



## K16.9 Special projects

Key special projects have been identified within the Precinct that require specific controls. These special projects include the following and are identified on **Figure K16-30**:

- Station Gateway East – mixed use area, land bridge and primary school
- Leeds Street Character Area
- Mixed use corners.

### Station Gateway East

#### Mixed Use Area

The Station Gateway East Character Area has been identified as a key gateway into the Precinct which builds upon its proximity to important rail and road connections.

Rhodes Station lies immediately adjacent to the Character Area, therefore providing an opportunity to develop into a mixed use area that provides a focus for convenience based retail, community uses and services, around a transit oriented centre (see **Figure K16-31**).

#### Objectives

- O1 To establish the Character Area as a transit orientated, convenience retail and mixed use centre for Rhodes East.
- O2 To ensure that this Character Area contributes to the overall legibility of Rhodes East and create a gateway landmark mixed use centre in the Precinct.
- O3 To establish a safe, active, vibrant, mixed use environment to support the Station and attract investment, quality development and people.
- O4 To future-proof Rhodes East for public transport improvements.
- O5 To facilitate connectivity to and from the Station, across Concord Road and into Mcllwaine Park.
- O6 To promote and protect views from the Station to the water.
- O7 To encourage built form that enables view sharing within and across the Precinct and maximises solar access.

- O8 To ensure that Blaxland Road street level activation is not negatively impacted through the introduction of the station bridge.
- O9 To recreate attractive and cohesive streetscapes.
- O10 To ensure that buildings are compatible with the desired further character of the area in terms of building bulk and scale.
- O11 To ensure that development provides appropriate and sensitive transitions to existing and planned development.

| Controls |   |
|----------|---|
| C1.      | Station Gateway East - Commercial Space: 11,000 m <sup>2</sup><br><br>Aged Care is an encouraged use within Station Gateway East commercial space and is a permissible use within the residential floorspace allocation.  |
| C2.      | The built form must achieve a high quality of architectural design, maximise solar access to the public domain and demonstrate the achievement of view sharing within and across the Precinct.  |
| C3.      | Proponents are required to contribute to and provide spatial provisions as set out by the NSW government towards a station bridge for pedestrians and cyclists, that connects the Station Concourse across Blaxland Road through the Character Area, across Concord Road to Mcllwaine Park and the foreshore to the east. |
| C4.      | Where the bridge travels through the Character Area it shall be a minimum of 16m wide and form a Station Bridge Plaza. The plaza must have active, retail frontage. Refer to the station bridge and bridge plaza controls in the next section.  |
| C5.      | A visual impact assessment shall be undertaken at the Development Assessment stage illustrating any impact on views from the Station and Mcllwaine Park.  |

|      |   |      |  |
|------|---|------|--|
| C6.  | Design along Concord Road must respond to, and prioritise the provision of, future public transport improvements and provide high quality infrastructure for customers incorporated into the built form and public domain design.   | C11. | Bridge Plaza frontage: <ul style="list-style-type: none"> <li>• Is in addition to the requirement of ground floor active frontage required in the LEP plan.</li> <li>• Is required in accordance with the detail plan and cross section.</li> <li>• Must adhere to the requirements of the 'Friendly Facade' – see <i>Section K16.5 (Façade design subheading)</i>.</li> </ul> |
| C7.  | Provision of a convenience supermarket on site must provide residential above.  | C12. | The proposed development must comply with 3m ground floor setback and minimum 4m upper podium setback facing Concord Rd  |
| C8.  | Areas identified for specialty retail must: <ul style="list-style-type: none"> <li>• Adhere to the requirements of the 'Vibrant Facade' – see <i>Section K16.5 (Façade design subheading)</i>.</li> <li>• Not exceed a 10m individual shop frontage.</li> <li>• Utilise either the Retail Shopfront and Awning or Posted Veranda frontage type.</li> <li>• Provide adequate pedestrian scale lighting, integrated into bollards and street furniture, wherever possible.</li> </ul>                 | C13. | A minimum podium height of approximately 14-16m building height is required facing Concord Rd.   |
| C9.  | Street level development fronting Concord Road that comprises a large floorplate use with minimal windows and address such as a supermarket and or carpark must utilise the frontage types provided for 'Mixed Facades' with podium – see <i>Section K16.5 (Façade design subheading)</i> .   |      |  |
| C10. | Upper level retail address: <ul style="list-style-type: none"> <li>• Is in addition to the requirement of ground floor active frontage required in the LEP plan.</li> <li>• Is required in accordance with the detail plan and cross section.</li> <li>• Where not related to ground level location, the 'Vibrant Facade' requirements shall be applied – see <i>Section K16.5 (Façade design subheading)</i>.</li> <li>• Outdoor verandas, dining or public activity space is required.</li> </ul> |      |  |

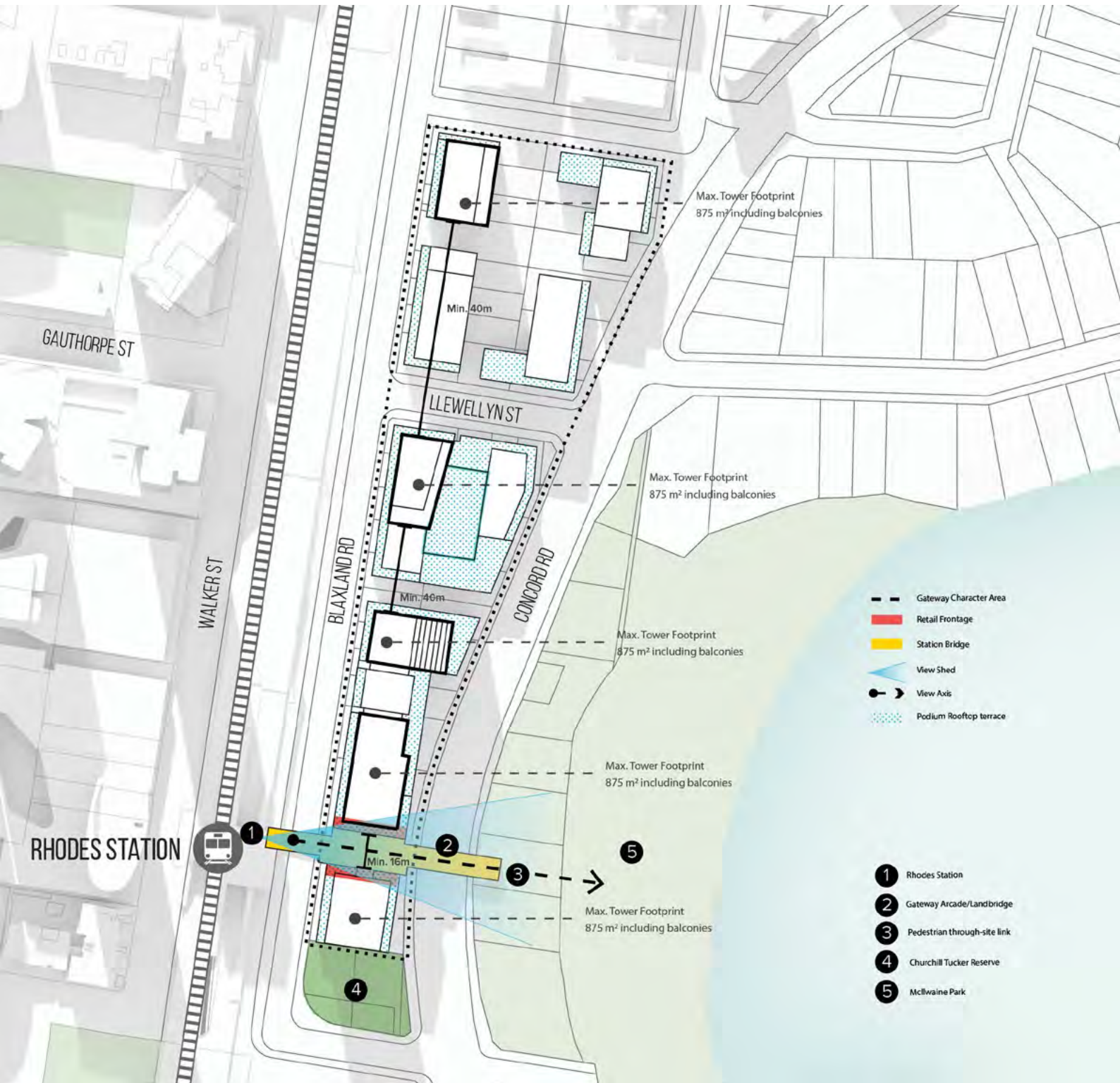

Figure K16-30 Station Gateway East Character Area Regulating Plan

### Station Bridge and Station Bridge Plaza

As part of Station Gateway East, a new station bridge is proposed which will provide a safe and convenient pedestrian connection between the station (and Rhodes West), the new community, and retail hub, and Mcllwaine Park (including the potential river pool), crossing both Blaxland Road and Concord Road.

Station bridge connections have the potential to transform disconnected urban neighbourhoods into thriving precincts. The bridge not only connects people, but also the landscape to the civic heart of Rhodes. The proposed higher density development at Station Gateway East creates an opportunity for this key public infrastructure to be funded as part of a major private development.

The station bridge will be developed with adherence to the key design parameters outlined by the NSW "Pedestrian Bridge Design Standards for Built up Areas", in particular the minimum clearance height of 5.5m. It is proposed that ramped walkways be provided (as well as steps) to provide inclusive access to Mcllwaine Park.

### Objectives

- O12 To create a gateway landmark mixed use centre for Rhodes East.
- O13 To future- proof Rhodes East for public transport improvements.
- O14 To ensure that this Character Area contributes to the overall legibility of Rhodes East.
- O15 To facilitate connectivity to and from the Station, across Concord Road and into the enhanced open space network.
- O16 To promote and protect views from the Station to the water.
- O17 To establish this Character Area as the transit oriented, convenience retail and mixed use centre for Rhodes East.
- O18 To create a safe and active pedestrian bridge link.
- O19 To ensure that Blaxland Road street level activation is not negatively impacted through the introduction of the pedestrian bridge.

- O20 To create attractive and cohesive streetscapes.
- O21 To ensure that buildings are compatible with the desired future character of the area in terms of building bulk and scale.
- O22 To ensure that development provides appropriate and sensitive transitions to existing and planned development.

### Controls

|      |   |
|------|---|
| C14. | A pedestrian bridge is to be provided that connects the Station Concourse to the rooftop Bridge Plaza, across Concord Road and to Mcllwaine Park.   |
| C15. | <p>A Station Bridge Plaza must be:</p> <ul style="list-style-type: none"> <li>• An integrated development solution between land owners and IfNSW</li> <li>• Connecting to the Active Travel (Station and Mcllwaine Park)</li> <li>• A minimum width of 16m for the entire private development length, and accommodate a two-way pedestrian path and a separated two-way bicycle path including landscaping to the northern and southern edges.</li> <li>• A minimum of 550 sqm in area</li> <li>• 80% vibrant retail frontage and 15/ 20 doors/ 100 meters</li> <li>• Developed with adherence to the key design parameters outlined by the NSW "Pedestrian Bridge Design Standards for Built up Areas", in particular the minimum clearance height of 5.5m.</li> <li>• The stubs must be at least 8m wide</li> </ul> |
| C16. | Where the land bridge travels through the Gateway Precinct it shall be a minimum of 16m wide and be fronted by active, retail uses.   |
| C17. | The station bridge's eastern landing must be access compliant and integrate with public domain improvements at Mcllwaine Park.  |

|      |   |
|------|---|
| C18. | The station bridge is to be designed and constructed to have sufficient architectural integrity to support deep soil planting and landscaping, integrating stormwater management, native planting and irrigation. The deep soil planting is to be a minimum of 2m width and span the entire lengths of the northern and southern edges of the bridge across Concord Road. |
| C19. | A visual impact assessment shall be undertaken at the DA stage illustrating view impact from the Station and from Mcllwaine Park.   |
| C20. | Advertising structures are not permitted to be attached or placed on the land bridge.   |

|      |   |
|------|---|
| C21. | The Bridge Plaza should incorporate tree planters to provide amenity, shade and contribute to quality urban space. The planters are should be offset a minimum of 3m from the retail frontages to retain circulation. The raised planters feature single large specimen trees of a variety of species (both evergreen and deciduous) to provide a balance of year-round seasonal variation, solar access and shade. |
| C22. | The pedestrian bridges must be designed in accordance with TfNSW requirements. It is vital that the design aesthetic of these bridges is exemplary. Guidance on achieving best practice outcomes for pedestrian bridges in NSW is provided by NSW Government’s Centre for Urban Design document “Bridge Aesthetics: Design guideline to improve the appearance of bridges in NSW”, Feb 2019.                        |







Examples of the desired use of tree planters on the bridge plaza



Examples of the desired vegetation on the bridge plaza



Examples of the bridge design



Artist impression of the indicative desired character of the Bridge Plaza

## Urban Primary School

There is the potential for an urban primary school to be delivered using SIC funding potentially collocated with multi-purpose community space. The central location of the Station Gateway East on the Rhodes Peninsula, in addition to the proximity to the public transport network.

### Objectives

To provide a primary school suitable to accommodate up to 1000 students.

O23 To be supportive of the SINSW general educational principles.

O24 To provide amenity for the new school and the shared use of school facilities.

### Controls

|      |   |
|------|---|
| C23. | <p>Any application for a school is to demonstrate how shared public facilities will be accommodated, through:</p> <ul style="list-style-type: none"> <li>• Community and/or administrative facilities that are accessible to the public</li> <li>• Open space that is accessible to the public outside of school hours and on the weekends</li> </ul> |
| C24. | <p>Open Space of the School Site must not receive any additional overshadowing from new development between 10.00am and 2.00pm on the Winter Solstice.</p>  |

## Leeds Street Character Area

An active destination and experience-based retail offering at Leeds Street, is consistent with the Character Area intent. It will be a unique destination and could successfully operate with limited and / or no parking requirements. It will be the northern bookend and ultimately linked by the continuous foreshore boardwalk to the Station.

The proposed ferry wharf location has been identified north of the Leeds Street providing a unique opportunity to provide a water- based transit focal point.

The large, light industrial landholdings in this area make amalgamation less challenging, increasing the likelihood of early redevelopment.

The topography, foreshore location and existing land use make the Precinct an ideal location for a density that could support a public domain contribution in the form of foreshore plaza space or similar. Increased density in this location was supported by the community.

### Objectives

- O25 To create an active, destination / experience - based retail offering adjacent to the water.
- O26 To establish a safe, active, vibrant, mixed use environment to support and promote use of the Ferry and that will attract investment, quality development and people.
- O27 To ensure the Character Area is not dominated by a single supermarket use.
- O28 To provide inclusive public access to the foreshore.
- O29 To give pedestrians priority at Leeds Street.
- O30 To facilitate connectivity along the River and Foreshore Promenade including to and from the future Ferry Stop.
- O31 To provide a variety of public open space at the waterfront that is usable for all ages and abilities.
- O32 To protect and enhance views to the water.

### Controls - Uses

|      |  |
|------|--|
| C25. | Potential specialty destination uses may include: micro-brewery, wine, cheese, olives, wine bars, cafés, small gourmet supermarket.  |
| C26. | Areas identified for specialty retail must: <ul style="list-style-type: none"> <li>• Adhere to the requirements of the 'Vibrant Facade'.</li> <li>• Not exceed a 10m shop frontage.</li> <li>• Utilise either the Retail Shopfront and Awning or Posted Veranda frontage type.</li> <li>• Provide adequate pedestrian scale lighting and integrated into bollards and street furniture wherever possible.</li> </ul> |
| C27. | Where retail uses, such as tables and chairs, spill out into the plaza, these activities must ensure public access is unhindered by fencing or other structural barriers.  |

### Controls - Design

|      |  |
|------|--|
| C28. | Development along frontages identified as 'Promenade Frontages' must utilise the frontage types provided for 'Vibrant Facades' – see <i>Section K16.5 (Façade design subheading)</i> of this DCP.                              |
| C29. | Ground floor residential units must have individual unit access.   |
| C30. | Pedestrian links must be activated on all sides for a minimum of two storeys with vibrant retail at ground floor and residential surveillance and balconies above unless upper level retail is specified on the plan opposite. |
| C31. | Residential towers above podium level shall have a maximum total floor area of 875sqm .  |
| C32. | A minimum podium height of approximately 14-16m building height is required.   |

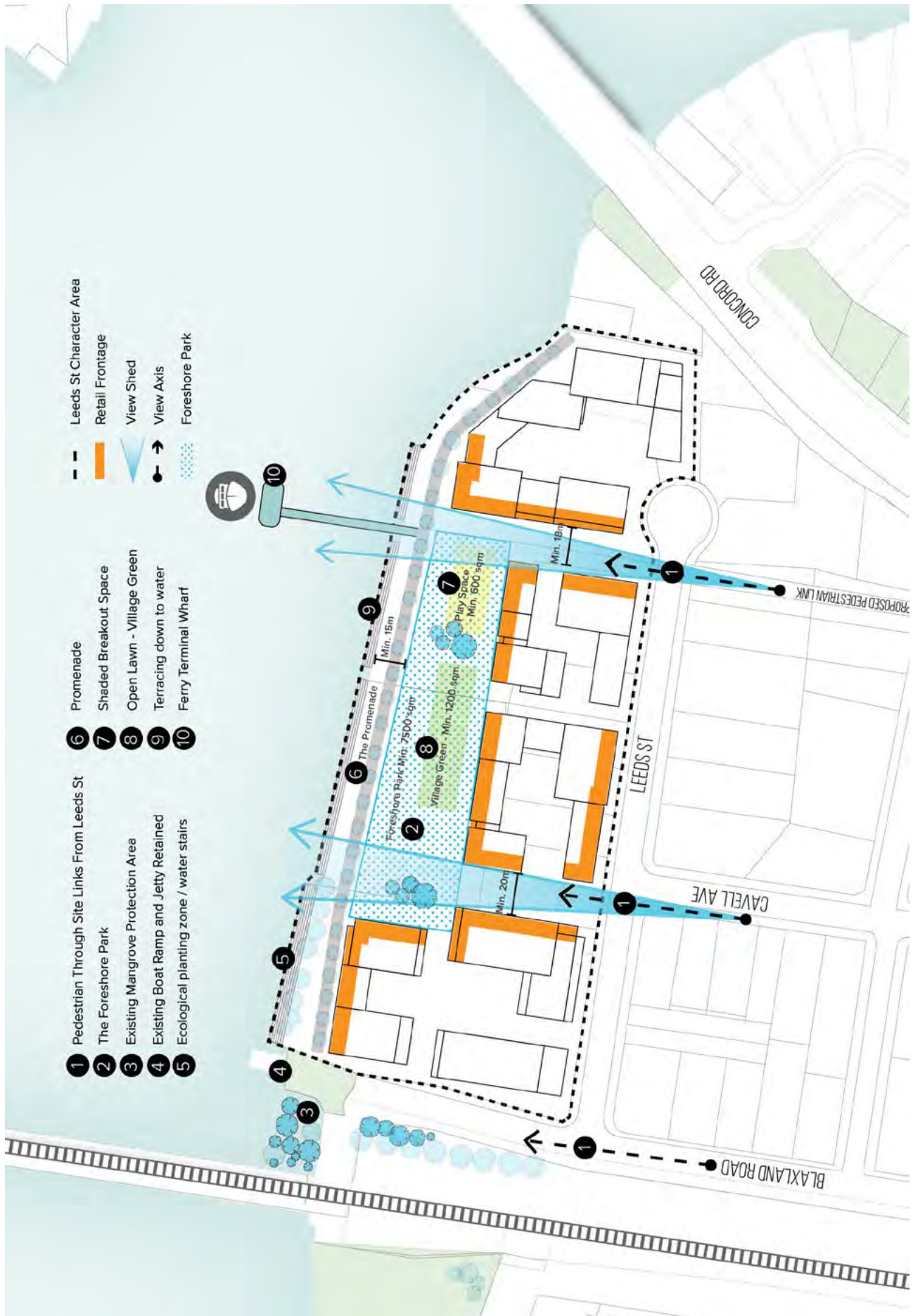

Figure K16-31 Leeds Street Character Area Regulating Plan

| Controls - Open Space |  |
|-----------------------|--|
| C33.                  | <p>A variety of open spaces should be provided within the Character Area, including;</p> <ul style="list-style-type: none"> <li>• Foreshore Promenade</li> <li>• Foreshore Park</li> <li>• Multi use paved space for sports and events</li> <li>• Pedestrian connection to the new Ferry Wharf</li> <li>• Access to the existing boat ramp and jetty</li> <li>• Terracing to the water edge.</li> </ul>  |
| C34.                  | <p>The Foreshore Promenade must be 15m wide and should be designed in accordance with <b>Figure K16-33</b>.</p>  |
| C35.                  | <p>The promenade must provide a continuous path of travel along the foreshore edge, minimum 5m in width, consistent with the existing Rhodes West foreshore, and with alignments that connect seamlessly with the existing and future promenade to the west and east, respectively.</p> <p>Large trees with a minimum mature canopy diameter of 10m should be incorporated into the Foreshore Promenade, and spaced to achieve a continuous canopy in maturity, Utilising deep soil available, these trees will grow to provide shade and amenity to the promenade walk and active water edge, and make a significant contribution the sense of place.</p> |
| C36.                  | <p>A minimum 50% of foreshore edge must step down into the river, and minimum of one equal access location provided to mean high tide level. The remainder of edge may consist of elevated terraces (with appropriate fall protection) or 'natural' edges (such as rip rap walling, mangrove planting, etc.).</p> <p>Open views to the water at eye level must be retained for at least 50% of the park interface</p>  |
| C37.                  | <p>The Foreshore Park should be designed in accordance with <b>Figure K16-32</b> and comprise a total of 7,500m<sup>2</sup>.</p>   |
| C38.                  | <p>The Foreshore Interface with the park is required to have a minimum 50% of its area free of obstructions. The remaining 50% may contain obstructions such as fixed and moveable seating, plantings and trees, light poles, public space signage, litter bins or other design elements that are permitted within public parks.</p>   |
| C39.                  | <p>A minimum clear zone of 3m offset from the façade interfacing with The Foreshore Park is required. The remaining 5m of Built Form Interface with the park is required to have a minimum 50% of its area free of obstructions. The remaining 50% may contain obstructions such as fixed and moveable seating, plantings and trees, light poles, public space signage, litter bins or other design elements that are permitted within public parks.</p>   |
| C40.                  | <p>A large level open lawn space must be provided in the park, with minimum dimensions of 20 x 60m, and grades in all directions of 1-2.5%. This space must be framed with seating and shade amenity.</p>  |
| C41.                  | <p>An inclusive play space should be incorporated into the park. The play space must be minimum 600m<sup>2</sup>. The range of play elements must cater for all abilities and ages, including young children, adults, and the elderly. The play experience must include bespoke elements that connect with the natural landscape and local context, contributing to a unique sense of place and creating an iconic destination.</p>  |
| C42.                  | <p>An amenities building must provided within the park, with accessible toilet/s and change facilities (babies, children, adults). Its location shall prioritise convenience from the ferry wharf and play space. The building shall be integrated into the park's design aesthetic and minimise disruption of water views from the park.</p>  |
| C43.                  | <p>The Blaxland Road terminus area (northern end) will be resurfaced, provide a multi use paved space for sports, recreation facilities and events. Landscape treatment must include new planting and on-site rain water detention / retention facilities.</p>   |

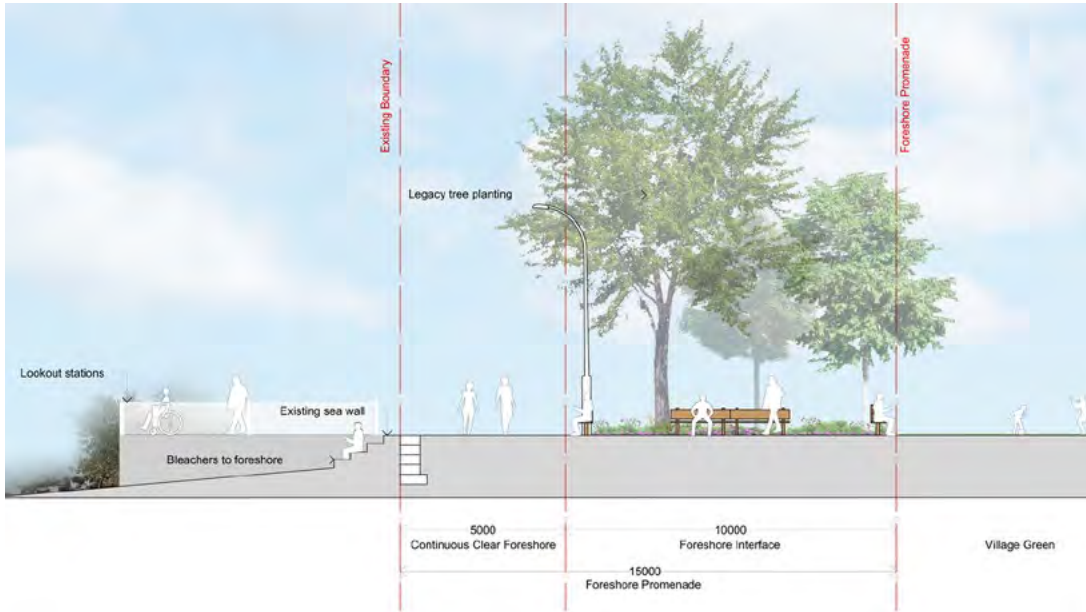

Figure K16-32 Foreshore / Park Interface (nts)

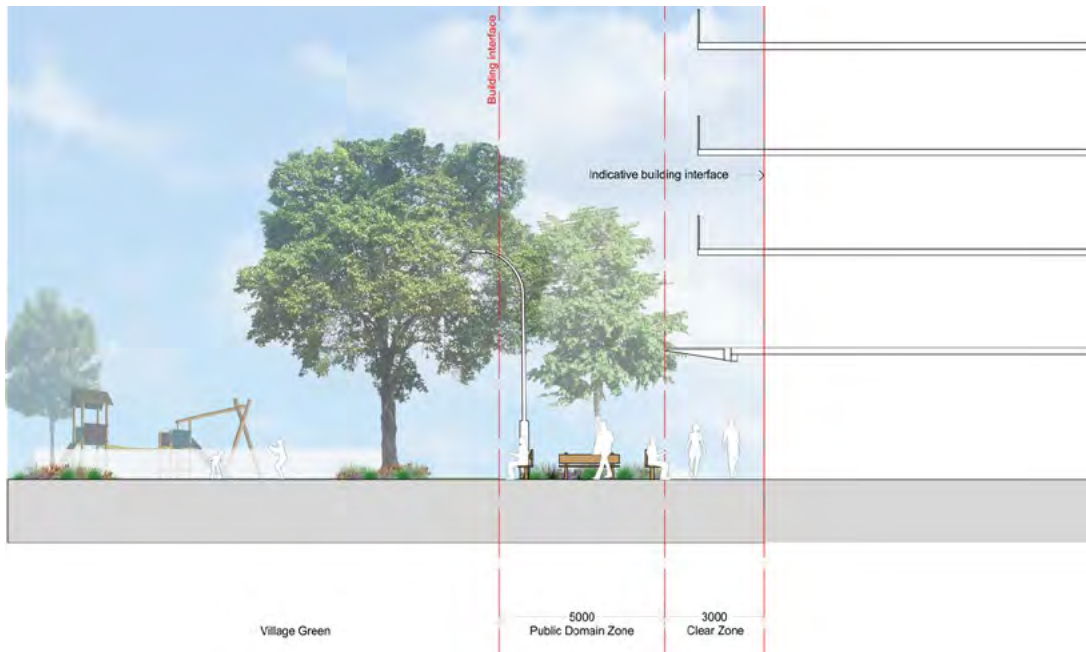

Figure K16-33 Built form / Park Interface (nts)

|      |   |
|------|---|
| C44. | <p>All areas of open space, including the Foreshore Promenade and Foreshore Plaza, must;</p> <ul style="list-style-type: none"> <li>• Be publicly accessible 24 hours a day, 7 days a week.</li> <li>• Be designed as an extension to the public domain.</li> <li>• Not be privatised through walls, fencing or the like.</li> <li>• Allow unobstructed pedestrian access at all times (with the exception of approved events and activities).</li> </ul> |
| C45. | <p>Uhrs Point Reserve will be upgraded with new planting, on-site rain water detention/ retention facilities and the provision of a launch ramp. (Note: any upgrades to the existing building facilities is the responsibility of the Sea Scouts and Crown Lands).</p>  |
| C46. | <p>The Foreshore Park must not receive any overshadowing from new development between 8.30 and 12.30pm in the Primary Zone on the Winter Solstice.</p> <p>The Foreshore Park must not receive more than 50% overshadowing from new development after 12.30pm on the Winter Solstice.</p>  |
| C47. | <p>King George Reserve must not receive any additional overshadowing from new development between 8.30am and 12.30pm on the Winter Solstice.</p> <p>Uhrs Reserve must not receive any additional overshadowing from new development between 8.30am and 12.30pm on the Winter Solstice.</p>  |
| C48. | <p>The proposed development within Leeds Street Character Area must not overshadow the open space of the school site between 10.00am and 2.00pm on the Winter Solstice.</p> <p>Location of school's open space is to be determined through detailed architectural design process.</p>   |
| C49. | <p>Development must demonstrate a response to areas identified as a Sculpture / Landscape / Public Art Feature.</p>   |

|      |  |
|------|--|
| C50. | <p>View sheds and visual axis must be protected and terminated by Architecture / Landscape / Public Art Feature.</p> |
|------|--|

#### Controls - Access

|      |  |
|------|--|
| C51. | <p>Primary vehicular access and servicing is to be provided via Blaxland Road.</p>   |
| C52. | <p>Pedestrian links and facilities for non-car modes of transport must be provided.</p>  |
| C53. | <p>The pedestrian links from Leeds Street to the northern foreshore are to be as follows:</p> <ul style="list-style-type: none"> <li>• Ferry Wharf pedestrian link 18m minimum width.</li> <li>• Cavell Avenue extension pedestrian link to be 20m minimum width.</li> <li>• Fronted by active, retail uses.</li> <li>• Open to the sky and unroofed.</li> </ul> |
| C54. | <p>Leeds Street Precinct basement carpark access/ servicing is to be:</p> <ul style="list-style-type: none"> <li>• Shared amongst all developments irrespective of land ownership and/ or land use in a superbasement or shared basement configuration in order to maximize deep soil potential underneath the Leeds Street Foreshore Park.</li> </ul>           |
| C55. | <p>Access to the new Ferry Wharf must be designed in accordance with the appropriate Transport for NSW standards and requirements. This could include disabled parking, vehicle turning heads, kiss-n-ride facilities and bus interchange opportunities.</p>   |
| C56. | <p>A wind impact assessment is required as part of any Development Applications relating to the Leeds Street Character Area. The assessment must demonstrate the mitigation of any wind impact through the design and architectural treatment of new buildings, without relying on the enclosure of laneways and through site links.</p>                         |



Figure K16-34 Section Location Plan



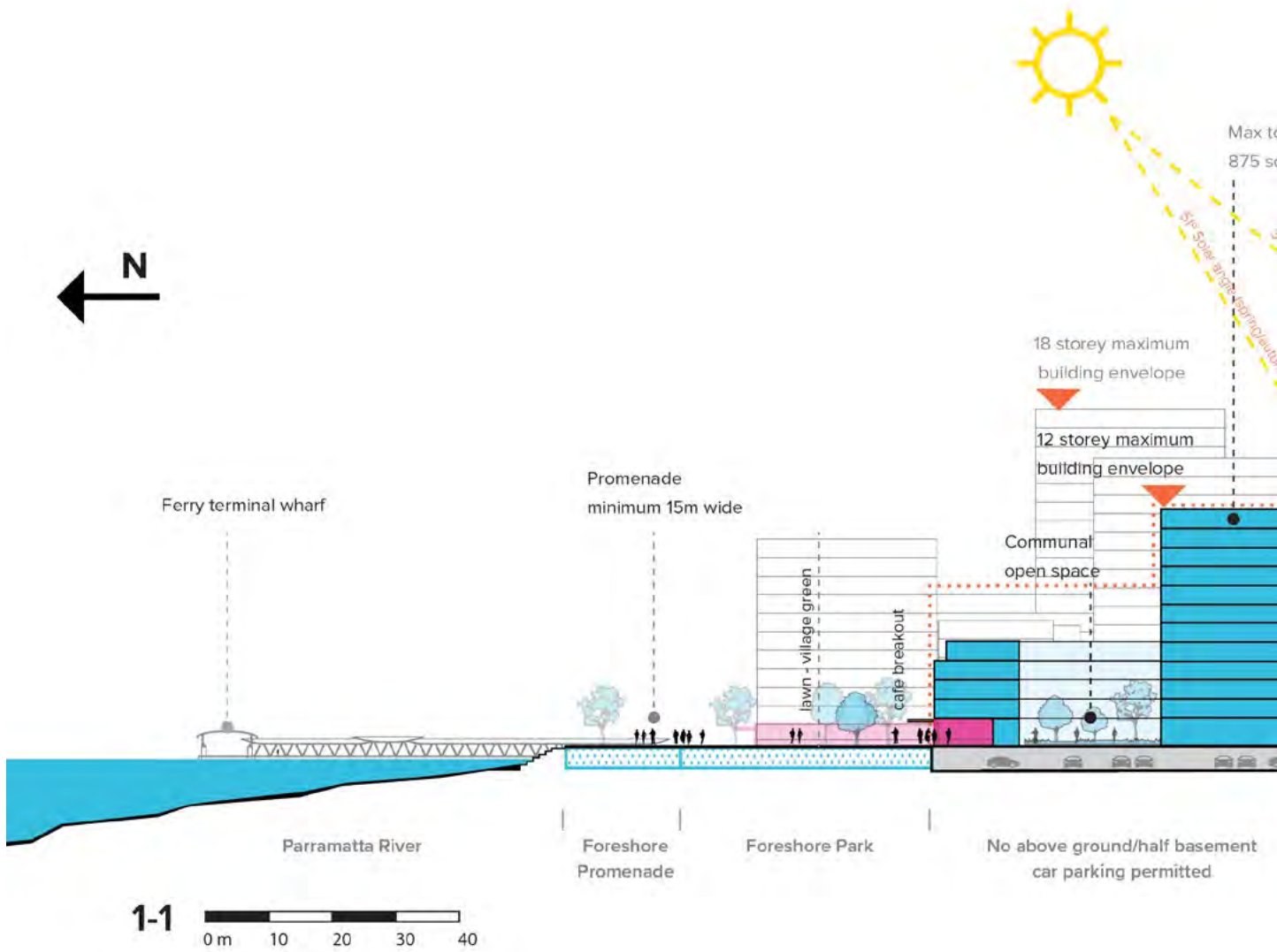
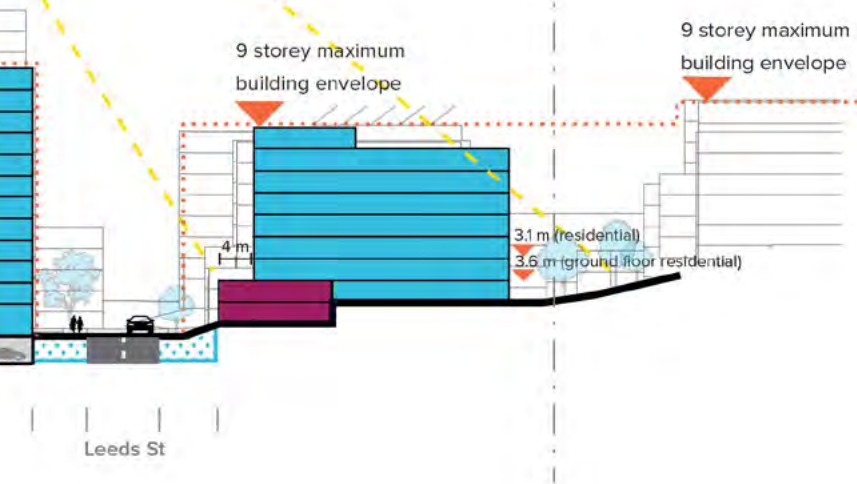

Figure K16-35 Section 1-1

Lower footprint  
including balconies

2° Solar angle (winter 12 pm)  
12 pm



- Public space
- Communal open space
- Residential
- Terrace housing
- Destination retail
- Underground parking

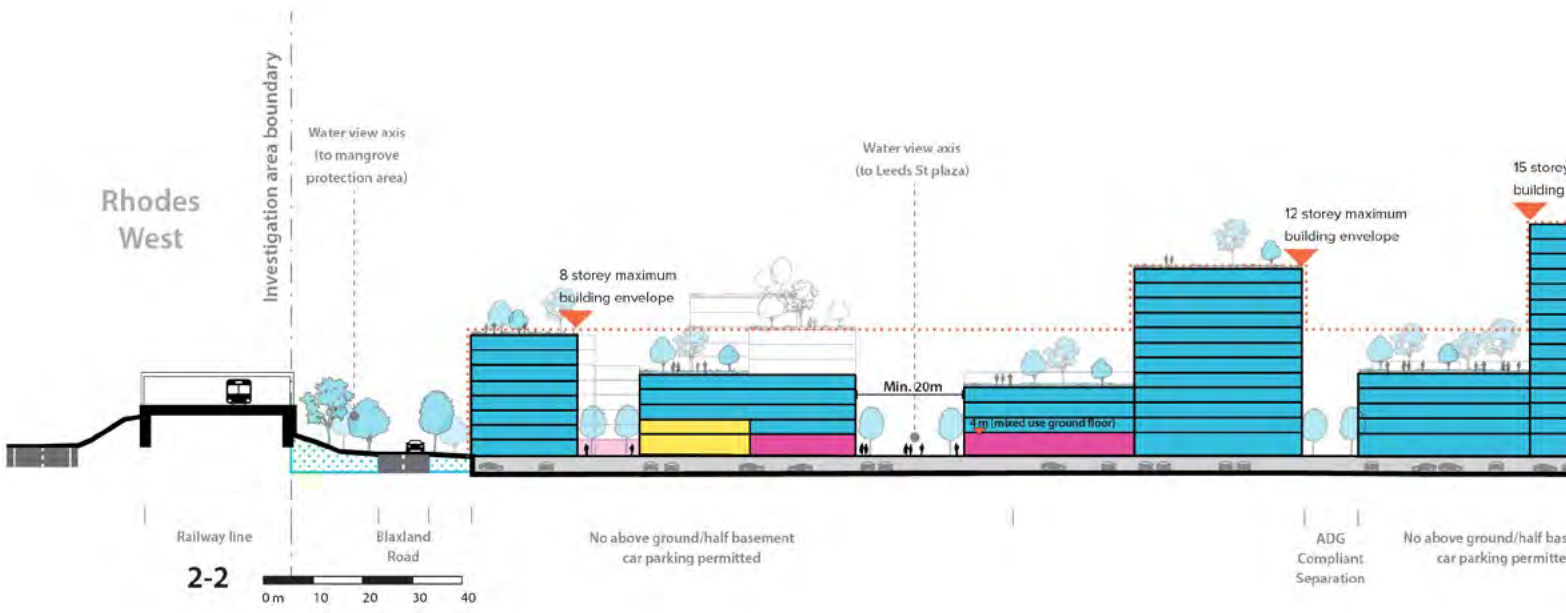
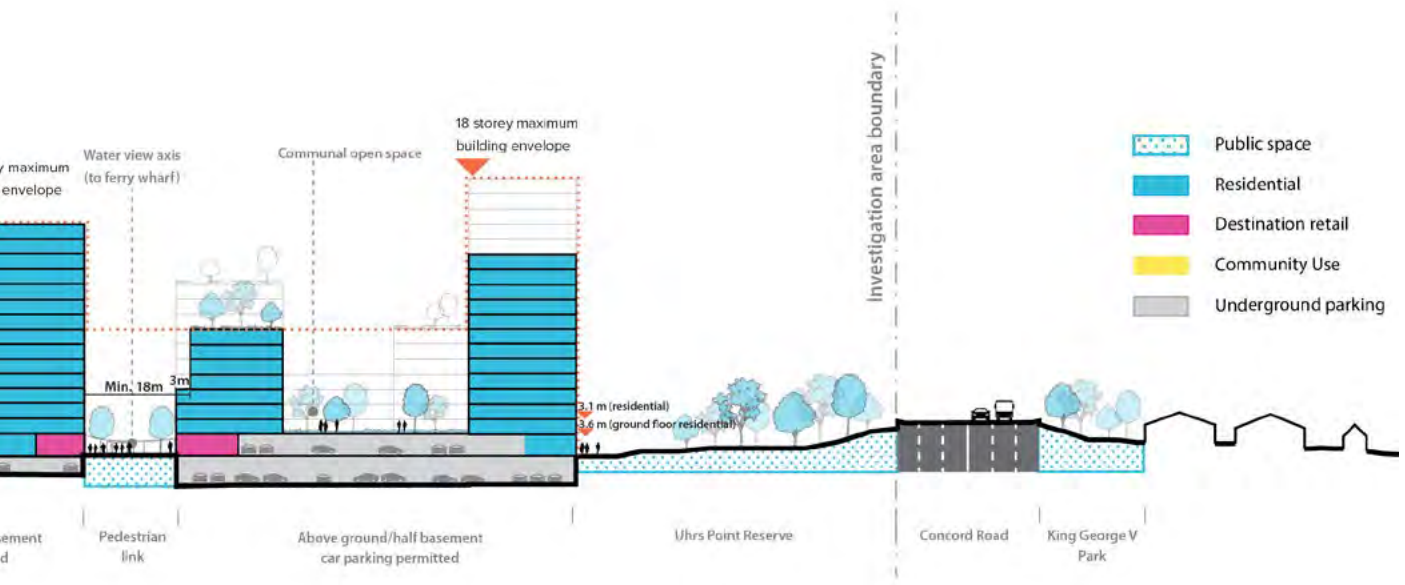

Figure K16-36 Section 2-2



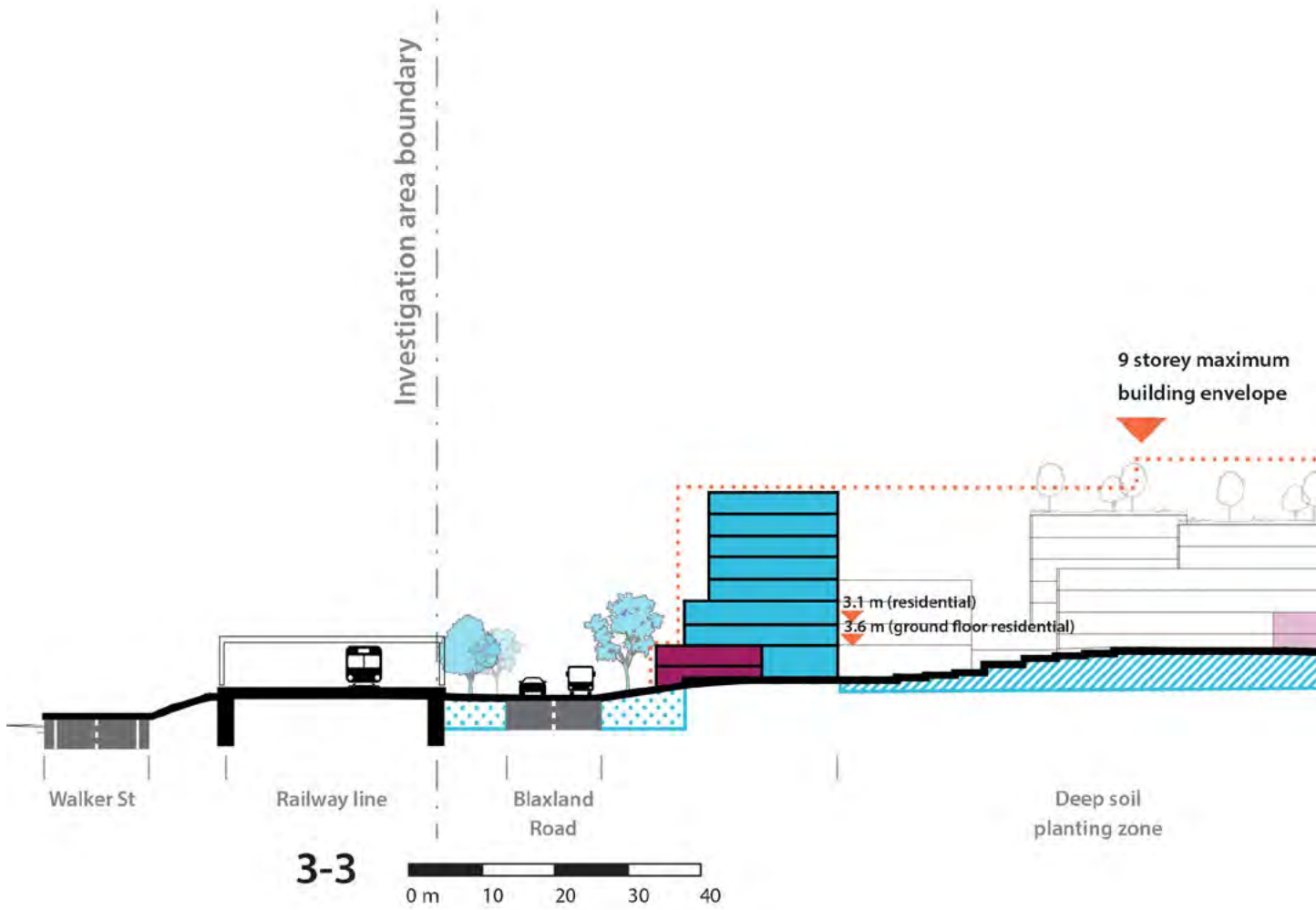
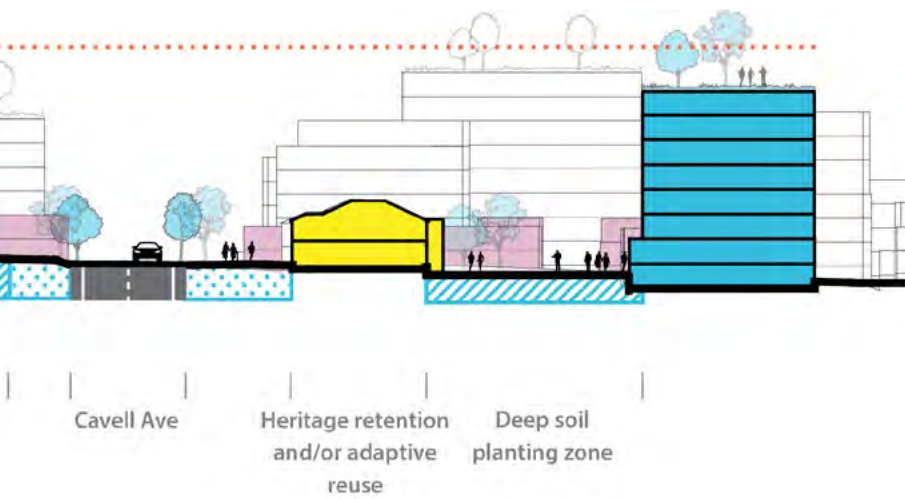

Figure K16-37 Section 3-3

-  Heritage Item
-  Public space
-  Communal open space
-  Residential
-  Terrace housing



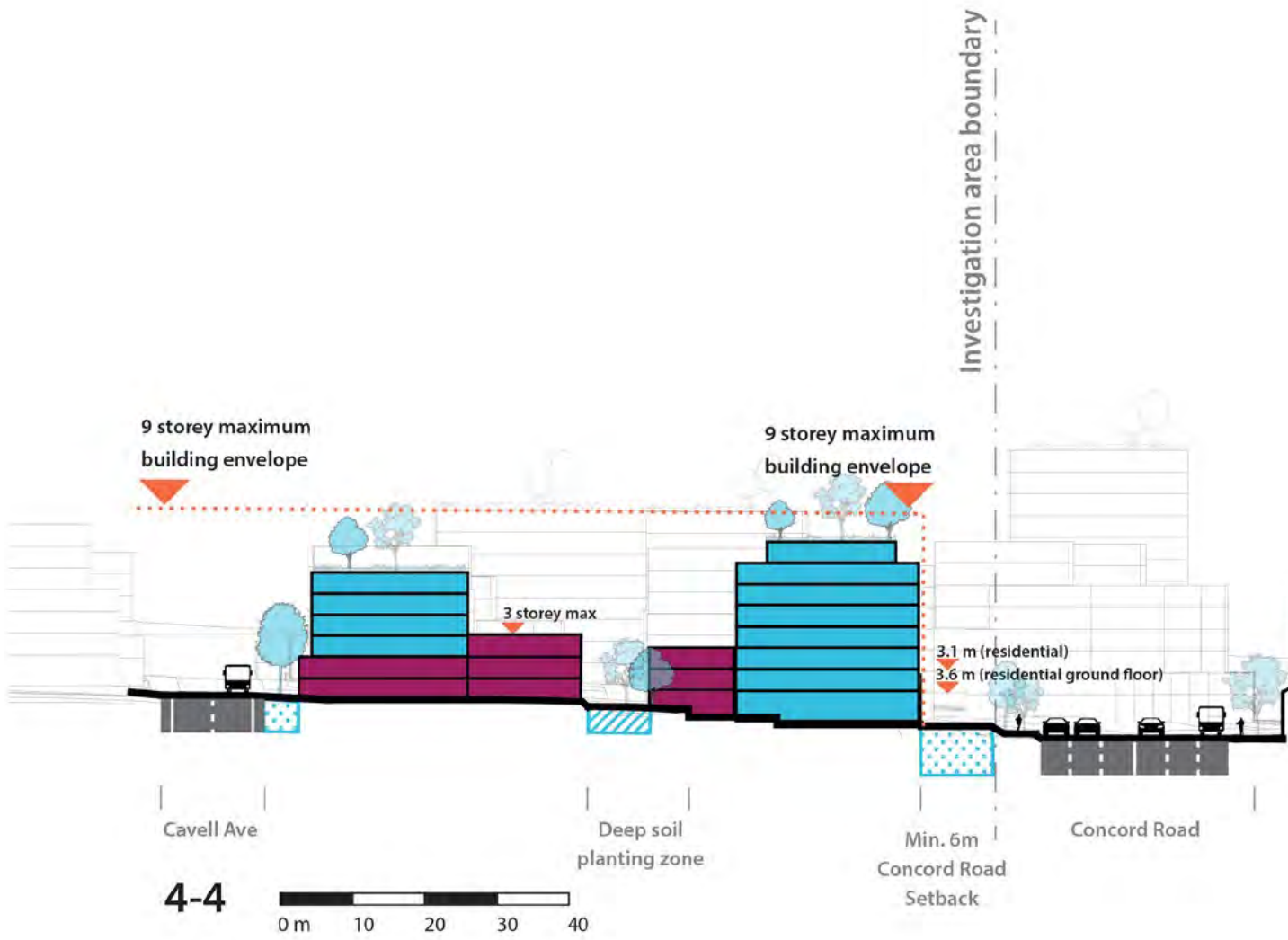
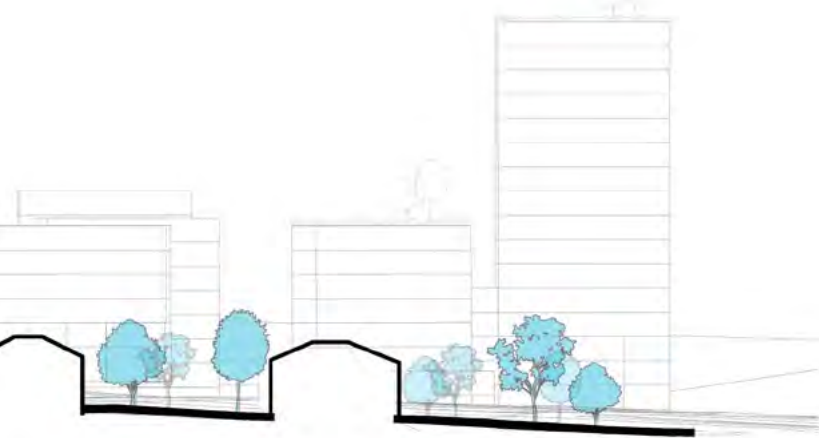

Figure K16-38 Section 4-4

-  Public space
-  Communal open space
-  Residential
-  Terrace housing





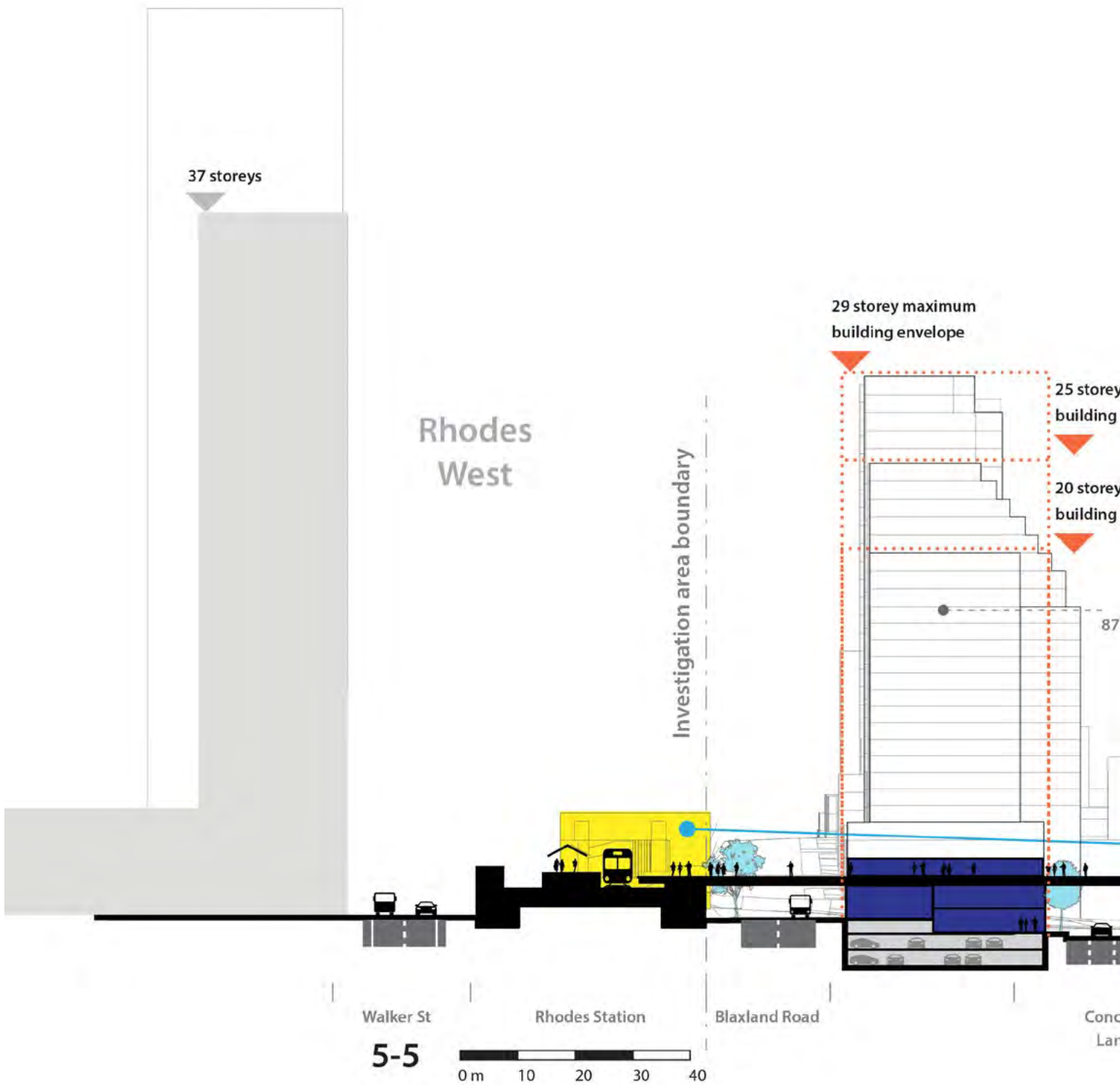

Figure K16-39 Section 5-5

maximum envelope

maximum envelope

Max tower floorplate  
5m<sup>2</sup> including balconies

- Public space
- Communal open space
- Residential
- Commercial
- Underground parking

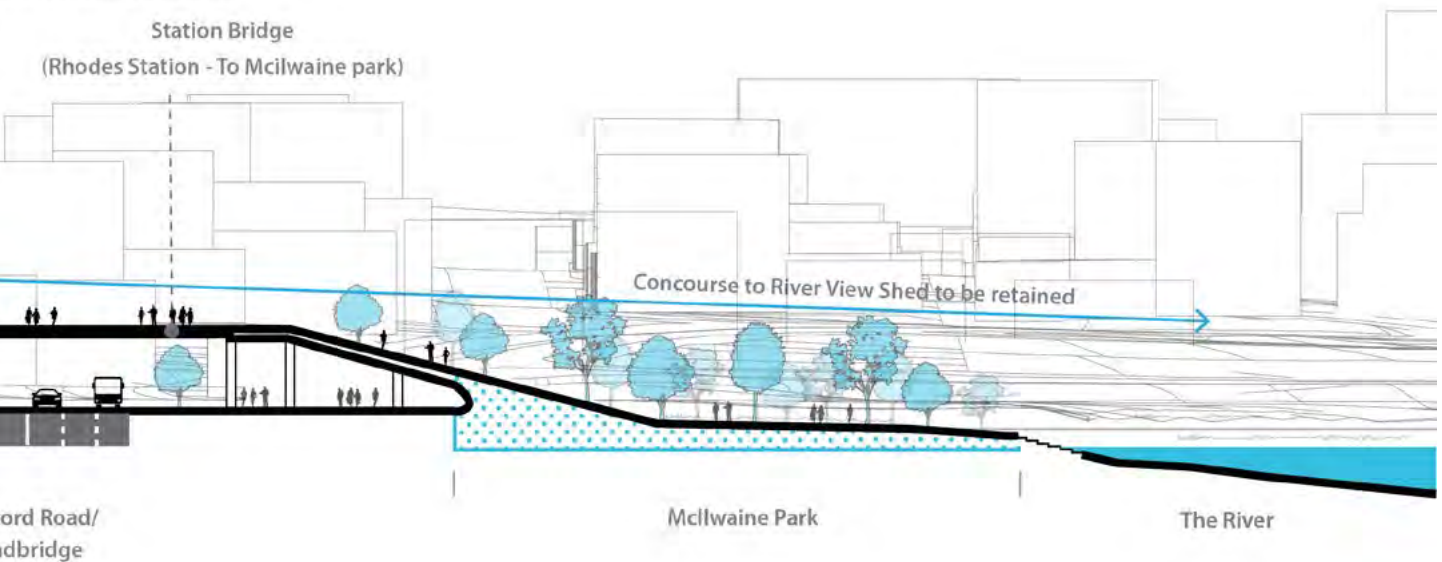

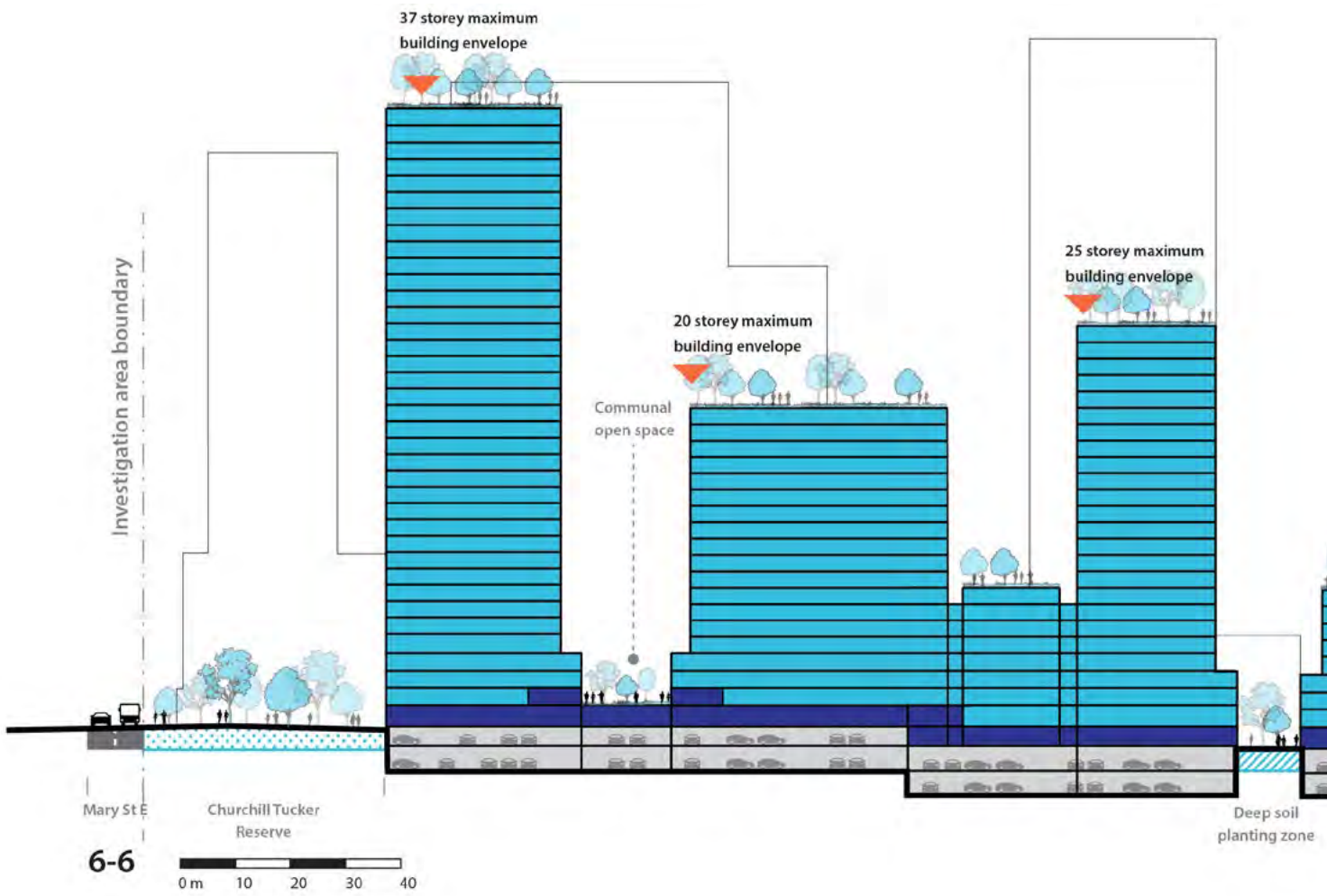
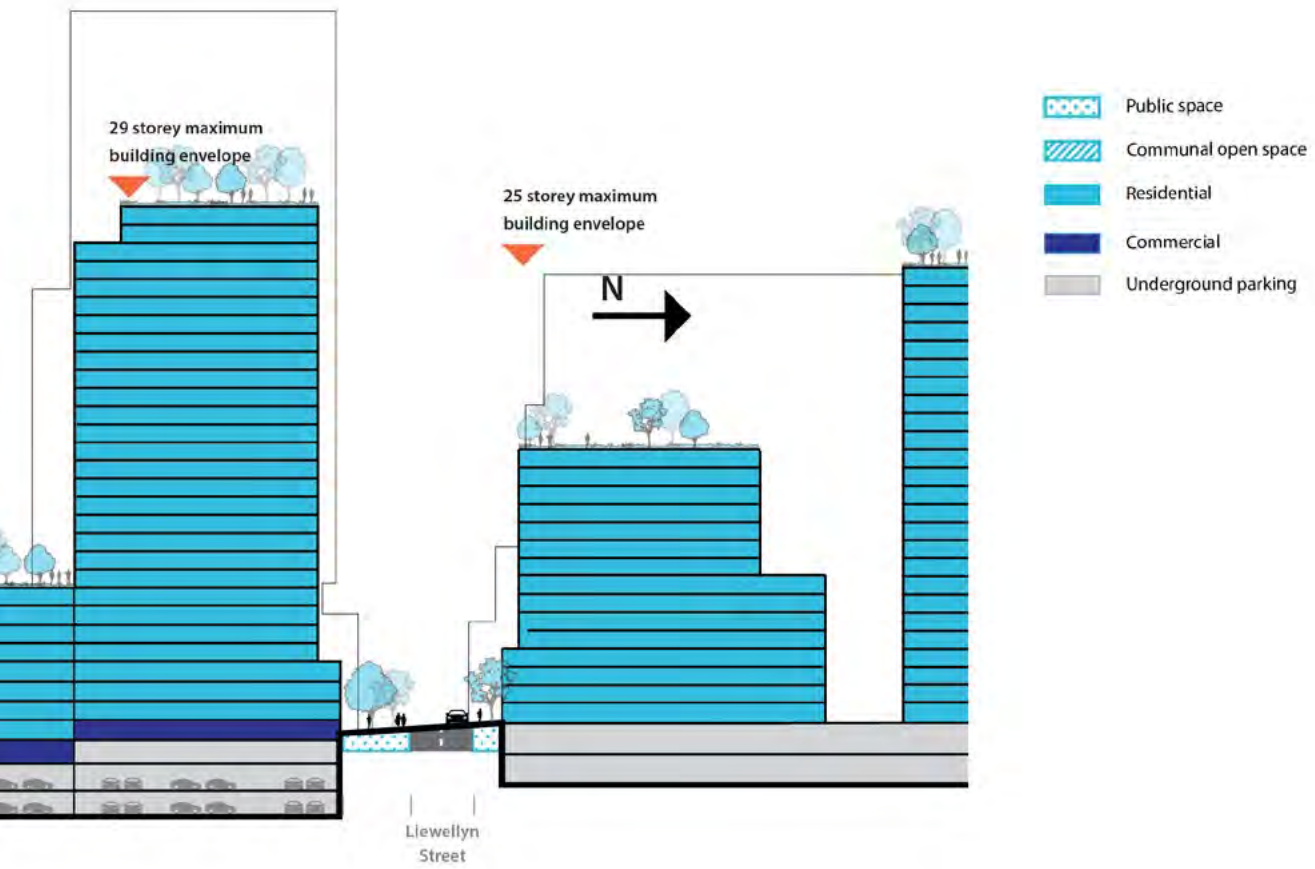

Figure K16-40 Section 6-6



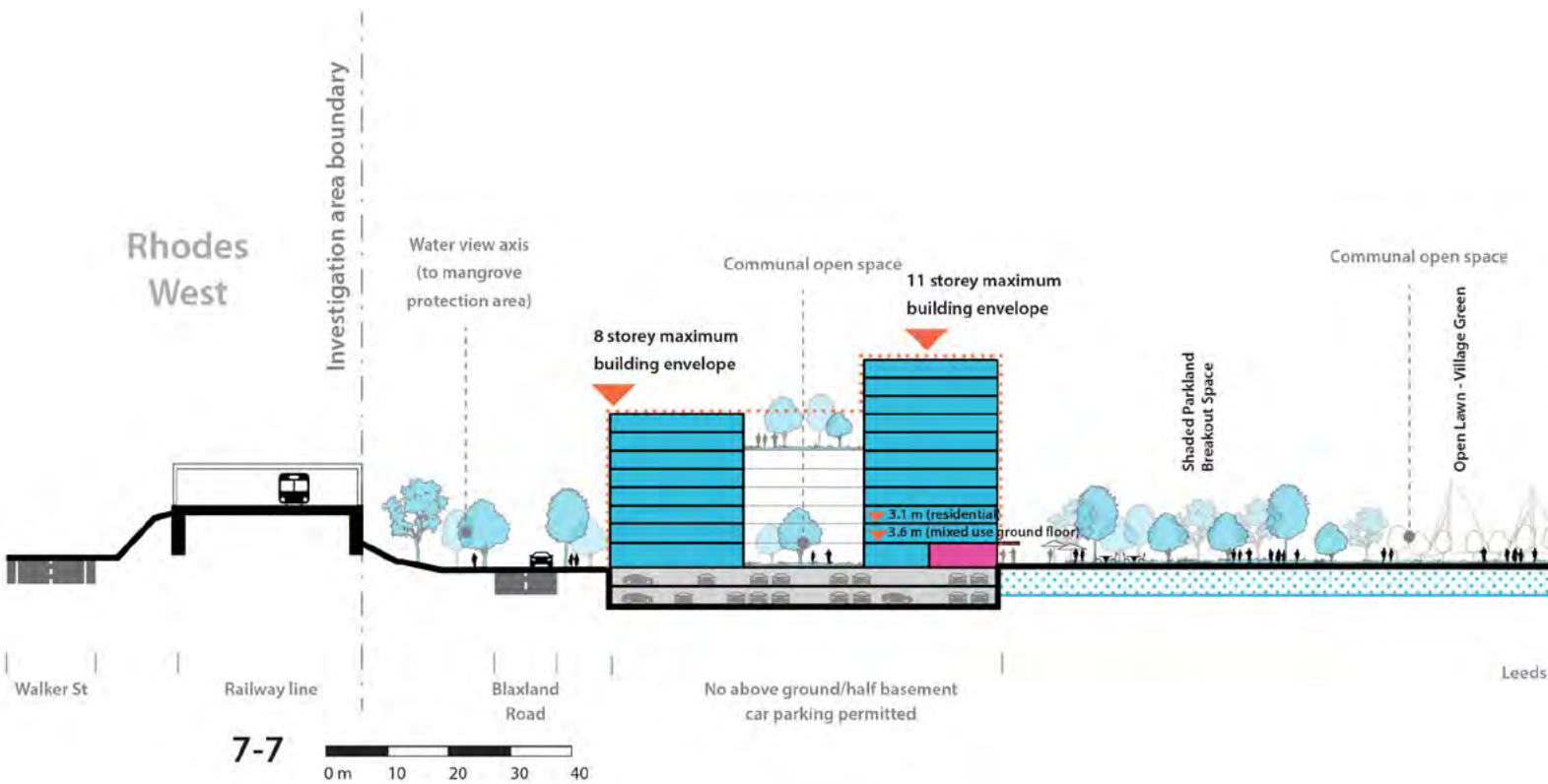

Figure K16-41 Section 7-7



### Mixed use corners

Three small mixed use corners with associated corner plazas have been strategically located along important desire lines within the Rhodes East Precinct.

### Objectives

- O33 To create intimate, localized spaces and gathering points for the community reflective of the Character Areas, co-located with small pockets of open space.
- O34 To provide frequent points of interest in between destinations, enabling better way-finding.
- O35 To embed opportunities for non-residential uses such as shops, cafes, start-ups and other small-scale commercial or community uses.

### Controls

|      |   |
|------|---|
| C57. | Mixed use corners are to be located as identified in <b>Figure K16-42</b> .   |
| C58. | The open space plaza associated with each mixed use corner must be: <ul style="list-style-type: none"> <li>• a minimum of 100m<sup>2</sup></li> <li>• Be publicly accessible 24 hours a day, 7 days a week.</li> <li>• Be designed as an extension to the public domain.</li> <li>• Not be privatised through walls, fencing or the like.</li> <li>• Allow unobstructed pedestrian access at all times (with the exception of approved events and activities).</li> </ul> |
| C59. | A minimum of 25m <sup>2</sup> ground floor GFA is to be used for the purpose of mixed, non-residential use addressing the open space/ plaza and be accessible at grade.   |
| C60. | Mixed use facades are at least 80% transparent and address the open space.  |
| C61. | The mixed use component may occupy the open space in the form of outdoor seating and/ or a raised platform.   |
| C62. | Upper level residential: <ul style="list-style-type: none"> <li>• must not have blank walls addressing the open space / plaza.</li> <li>• must not use the mixed use corner as a residential lobby.</li> </ul>  |





**Mixed Use Corner A (Concord Road):**

**Controls**

- C63. New development in this location:
- should reinforce its function as a key feature along Concord Road.
  - is to be in accordance with **Figure K16-43**.
  - is to provide a high degree of building and facade articulation to both street frontages with particular attention given to the view of the corner from the northeast.
  - is to provide landscape treatment is encouraged to attenuate noise associated with traffic on Concord Road.

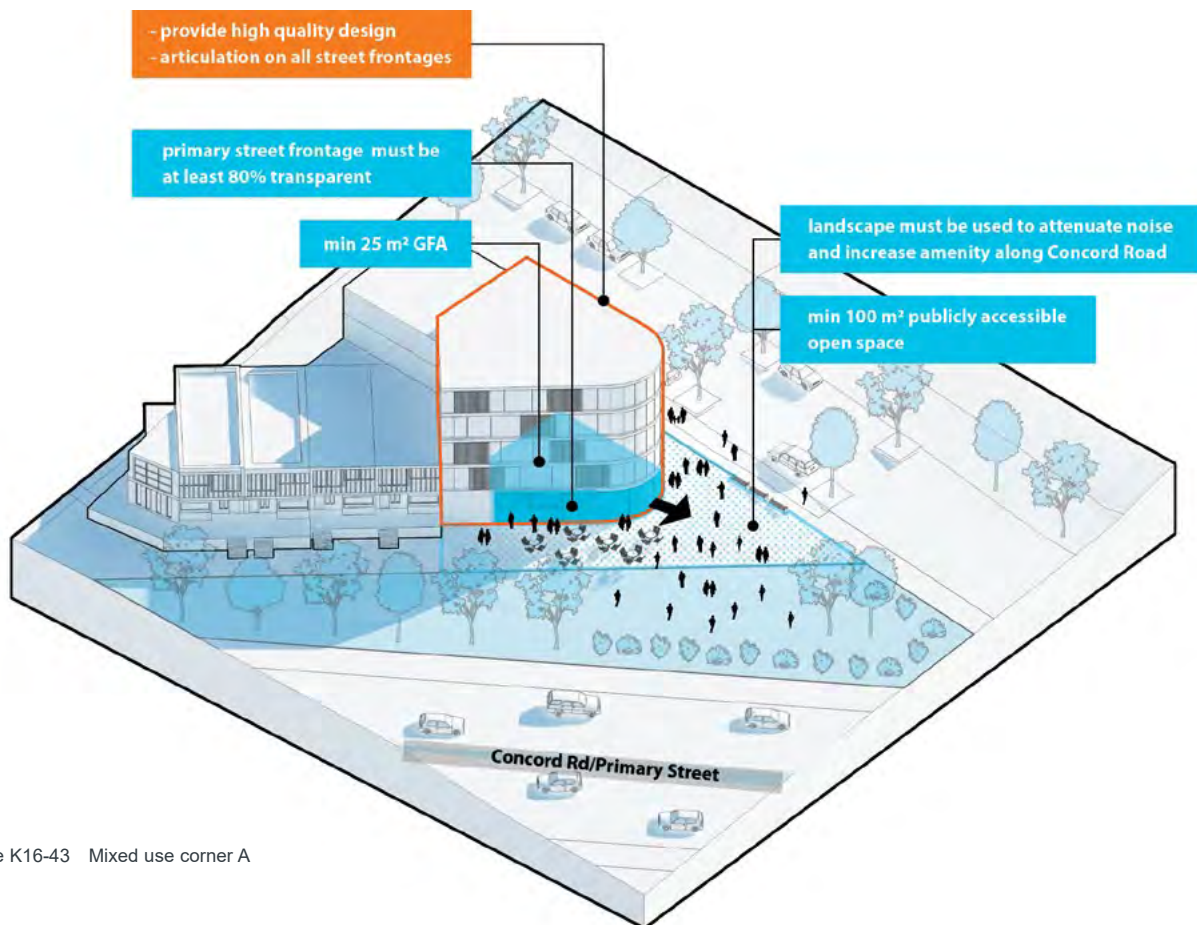

Figure K16-43 Mixed use corner A

**Mixed Use Corner B (heritage trees):**

| Controls |   |
|----------|---|
| C64.     | <p>New development in this location:</p> <ul style="list-style-type: none"> <li>• is to be in accordance with <b>Figure K16-44</b>.</li> <li>• is to be in accordance with the remnant tree heritage controls for 4A Cavell Avenue. Refer to <i>Section K16.6 (Heritage items subheading)</i> of this DCP.</li> </ul> |

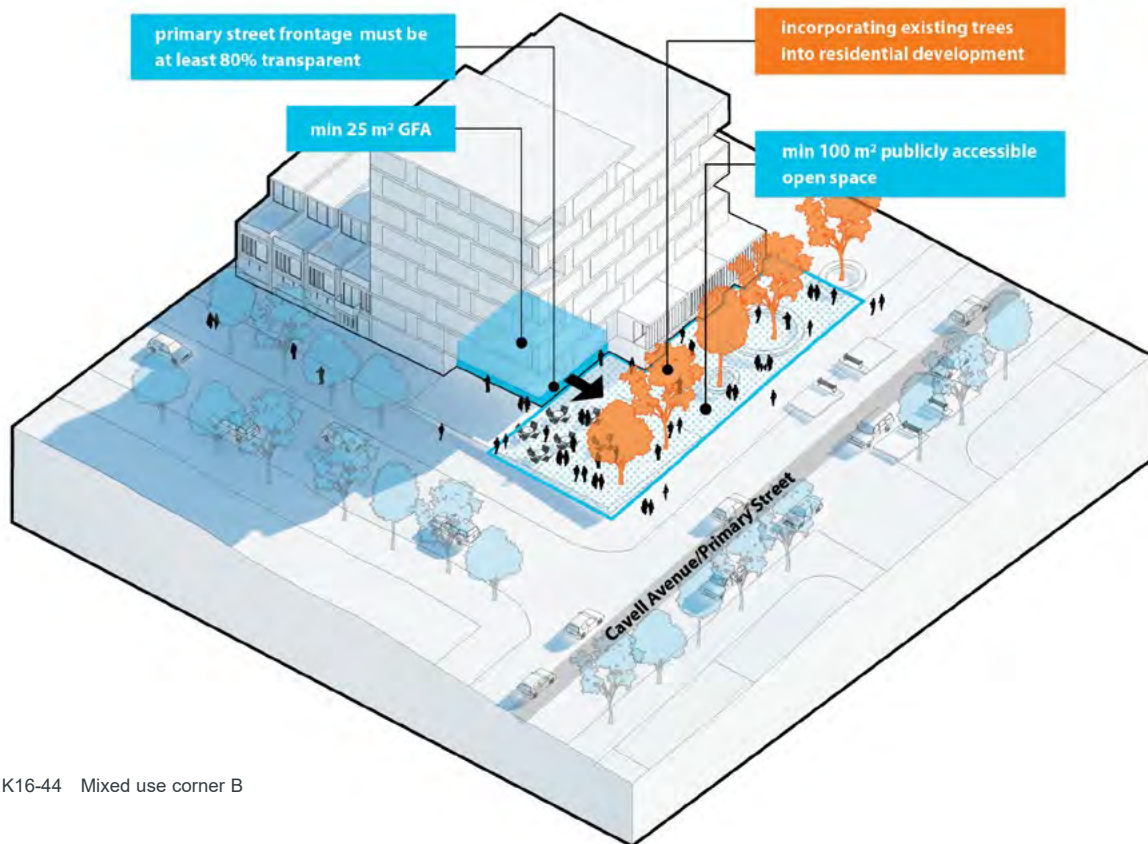

Figure K16-44 Mixed use corner B

**Mixed Use Corner C (Concord Road):**

**Controls**

- C65. New development in this location:
- should reinforce its function as a key feature along Concord Road.
  - is to be in accordance with **Figure K16-45**.
  - is to provide a high degree of building and facade articulation to both street frontages with particular attention given to the view of the corner from the northeast.
  - is to provide landscape treatment is encouraged to attenuate noise associated with traffic on Concord Road.

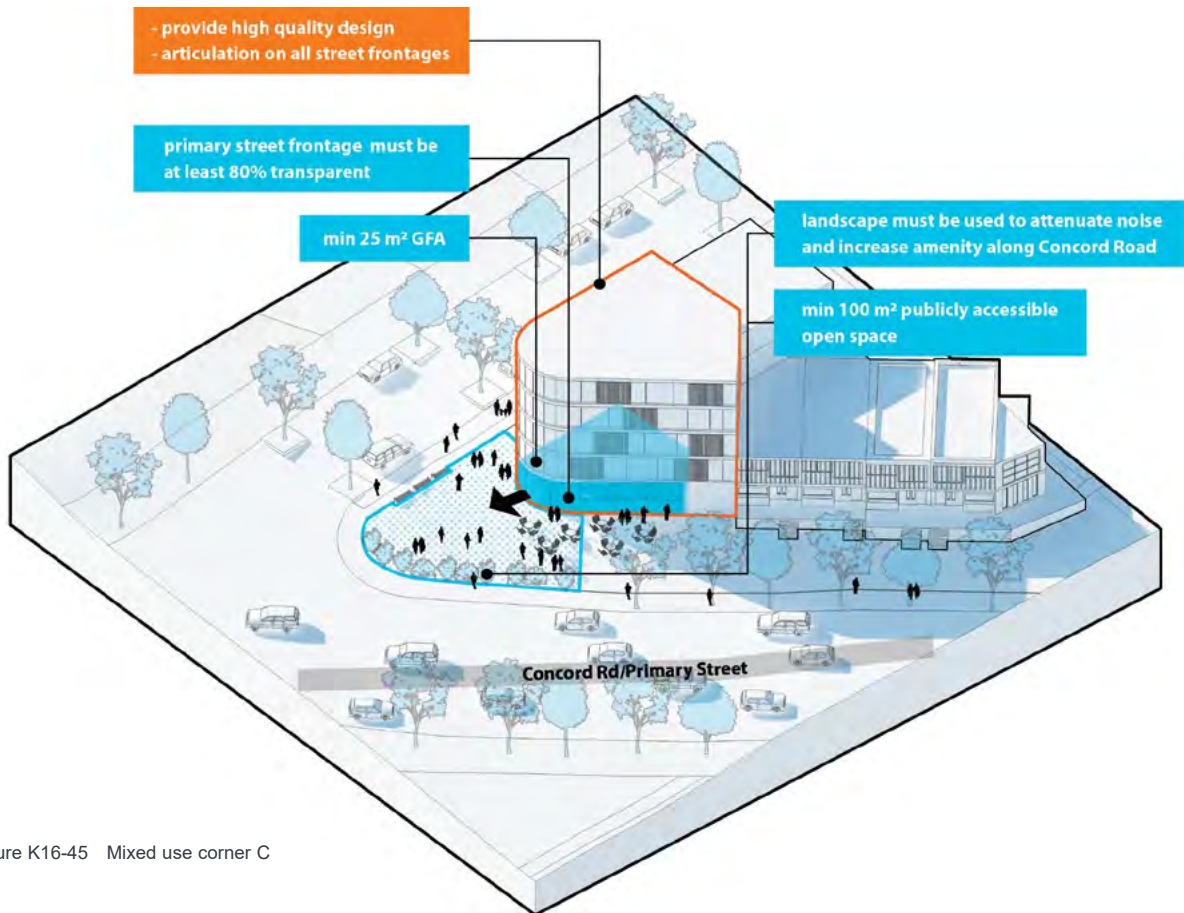

Figure K16-45 Mixed use corner C

**This page was intentionally left blank**

## K17 Rhodes West

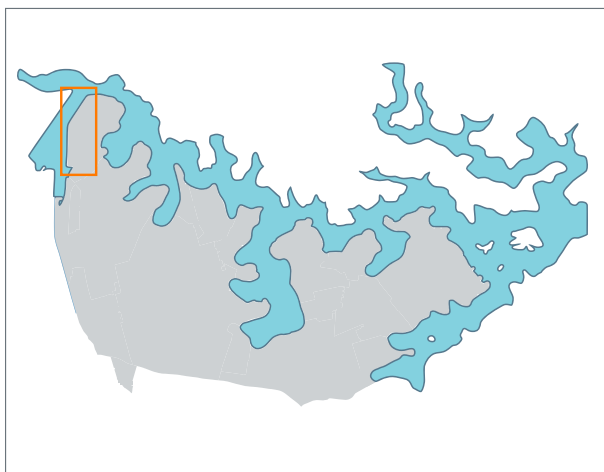

Figure K17-1 LGA map

### K17.1 Introduction

#### Preliminary

Rhodes West is a Specialised Centre in Canada Bay Local Government Area (LGA) located on the eastern shore of Homebush Bay, Sydney Harbour's western most bay. Rhodes West has progressively developed under a planning framework established in 1999 under the Sydney Regional Environmental Plan 29: Rhodes Peninsula (SREP 29) (Now repealed) and the Renewing Rhodes Development Control Plan 2000 (RRDCP 2000) (now superseded).

The City of Canada Bay Council was delegated the role of consent authority from the Minister for Planning in 2009. Since that time, Council has investigated the potential opportunities to enhance the community's facilities and public open space and to build on the existing urban design and planning framework to incorporate sound place making principles in the development of the remaining development sites.

The Rhodes West DCP 2010 formed an important part of the previous implementation of Council's vision for Rhodes West. This site and precinct specific DCP, Rhodes West DCP 2015, will continue and strengthen this vision to create a sustainable, liveable and well connected place on the peninsula.

This DCP includes:

- A Framework Plan to set the urban design structure for development sites; and
- Development controls for the public and private domain.

#### Vision

The 'vision' for Rhodes West is to:

1. Create a diverse and visually interesting commercial centre supported by a high density residential community;
2. Integrate the new community of Rhodes West with the existing community east of the Northern Railway line, Wentworth Point and Sydney Olympic Park through bus, pedestrian and cycle connections and the provision of new community facilities, which are accessible to all;
3. Engender a meaningful 'sense of place' and community with a network of activity areas that combine neighbourhood shops, recreation opportunities, and public open space with residential dwellings;
4. Create a range of high quality public open spaces and community facilities;
5. Ensure high quality architectural design that contributes positively to the role of Rhodes as a Specialised Centre in Sydney; and
6. Demonstrate leadership in ESD initiatives.

#### Aims and objectives

The intention of the Rhodes West Development Control Plan is to set the detailed development objectives and controls that support the Canada Bay Local Environment Plan 2013 (as amended).

#### Aims

The following Aims seek to implement Council's vision for a precinct of high quality urban design that is well connected, liveable and environmentally, economically and socially sustainable.



Figure K17-2 Rhodes West Precinct Plan

### High quality design

- A1 High quality public domain design to create memorable places that the community use and enjoy.
- A2 Pleasant streetscapes with active street frontages.
- A3 High quality architectural design that creates a visually interesting skyline as well as pleasant streetscapes.

### Well connected

Connectivity achieved by:

- A4 Supporting an integrated, well connected and accessible area to it's local and regional context.
- A5 Providing pathways and cycleways that link public spaces and activity areas through and between residential and mixed use areas and that link with adjacent residential areas.
- A6 Enhancing existing connections and creating new connections between Rhodes West and Rhodes East, Wentworth Point and Sydney Olympic Park which supports the proposed construction of the Homebush Bay Bridge between Rhodes West and Wentworth Point.
- A7 Promoting and providing a well connected network of public, private and communal areas which offer a range of recreational needs including places with high amenity for workers, local residents and other visitors to enjoy.

### Liveable

Liveability achieved by:

- A8 Establishing an urban design framework that optimises views, sunlight access and natural air movement and that minimises environmental impacts within Rhodes West and adjacent residential areas.
- A9 Providing safe and secure public spaces, pedestrian pathways and cycleways.
- A10 Providing well designed public open spaces through the use of high quality materials, street furniture and public art.
- A11 Promoting high levels of internal residential amenity in the design of communal areas and internal layout of dwellings having regard to visual and acoustic privacy, thermal comfort, natural airflow and ventilation, sunlight access, adequacy of storage areas, views and aspect.

### Sustainable

Environmental sustainability achieved by:

- A12 Promoting sustainable transport, reduce car use and increase use of public transport, walking and cycling.
- A13 Providing high quality open spaces and a range of recreational facilities.
- A14 Conserving the environmental heritage of Canada Bay.
- A15 Promoting ecologically sustainable development.
- A16 Supporting foreshore areas for parkland open space that balances the need for ecological restoration with functional open space required for public foreshore access.
- A17 Promoting a high level of building sustainability performance through energy and water efficiency.
- A18 Promoting waste minimisation in building construction and operation.
- A19 Promoting pedestrian and cycling network through integrated circulation and wayfinding which will provide safe and enjoyable access to facilities and open space.

Economic sustainability achieved by:

- A20 Promoting an appropriate mix of uses that will enhance the role of Rhodes as a Specialised Centre for employment growth.
- A21 Promoting a dwelling mix that supports demand for housing that is affordable whilst providing housing choice for a range of household types.

Social sustainability achieved by:

- A22 Providing community facilities of an appropriate use and size to cater to the demands of a growing population.
- A23 Providing an adequate amount of public open spaces designed to suit the needs of the growing population for a variety of passive and active recreational needs.

## Objectives

The DCP is based on the following objectives in support of Canada Bay Local Environment Plan 2013 (as amended).

### *Create a specific identify for Rhodes Peninsula*

- O1 Optimise the waterfront location by providing continuous public access to the foreshore that links adjoining parks.
- O2 Substantially retain the alignment of existing seawalls.
- O3 Design public open spaces that create a special amenity and passive and active recreation opportunities, which are safe and promote ease of pedestrian movement.
- O4 Retain and enhance opportunities for views from the public domain, including views to the water from along the ridge, to Homebush Bay and Brays Bay looking east and west along Mary Street, west along Parramatta River from the point, and to the Millennium Markers and Olympic Park.
- O5 Preserve the cultural heritage value of the place by retaining wherever practical existing streets, established stands of trees, site benching, prereclamation shoreline and the flat terrain of the reclaimed area.
- O6 Reflect and emphasis the topography with lower buildings at the foreshore and greater height to the east of Shoreline Drive.
- O7 Create a visible identity to Rhodes West through the design of high quality tower buildings of slender design.

### *Provide a street layout that maximises connections to all surrounding areas and creates a high quality public domain that is permeable and safe*

- O8 Integrate the east and west parts of the Rhodes Peninsula and improve pedestrian and cycle links to Concord West.
- O9 Build the Homebush Bay Bridge to provide connectivity for pedestrians and public transport between Rhodes Peninsula and Wentworth Point.
- O10 Provide for future flexibility by maximising connections to adjoining areas from Mill Park in the north, across the rail line in the east, and to Oulton Avenue in the south.

- O11 Create pedestrian and cycle connections from Bicentennial Park and Millennium Parklands in the south to the Leeds Street boat ramp in the north via streets and the foreshore reserve;
- O12 Improve pedestrian connections to the north by providing stairs from Mill Park to John Whitton Bridge and at the ferry wharf at Meadowbank;
- O13 Locate streets to enhance views to Homebush Bay, Parramatta River and associated open spaces, and ensure a view to water, open space or sky at the end of every street, to the maximum extent possible.
- O14 Establish a continuous network for vehicles, pedestrians and throughout the peninsula, close to the Railway Station, and minimise public dead end streets;
- O15 Create pedestrian permeability by providing through block pedestrian access;
- O16 Establish a hierarchy of streets that distinguishes between major streets for through traffic and public transport, and local streets to assist orientation and improve legibility;
- O17 Create a safe and vibrant public domain by designing streets as social spaces that incorporate a mix of transport modes, including pedestrians, cyclists, moving and parked vehicles;
- O18 Give pedestrians and cyclists priority in residential areas by means such as pedestrian through block connections, footpaths, kerb ramps, street trees, minimising vehicle crossings of footpaths, and designing minor carriageways for slow vehicle speeds to deter through traffic.

### *Create a range of public open spaces that complement and supplement the existing local and regional park network, and that maximise connections to all surrounding areas*

- O19 Contribute to the regional network by providing continuous public open space along the foreshore that is publicly accessible, connecting to Bicentennial Park and the Blaxland Road Boat Ramp and pedestrian/cycleway connections on John Whitton Bridge.
- O20 Contribute to the regional network by constructing the proposed Homebush Bay Bridge between Rhodes Peninsula and Wentworth Point creating the Homebush Bay Loop.



- O21 Provide a point park that extends the typology of point parks in the harbour and along the Parramatta River foreshores creating the Parramatta River Loop.
- O22 Provide an active Foreshore Park as the major public activity point along the foreshore, between Mary and Gauthorpe Streets.
- O23 Provide a conservation park which conserves the existing mangroves along the foreshore to the south.
- O24 Provide a linear reserve for local recreation including the three major foreshore parks, incorporating planting to extend habitat, enhancing the view of development from the reserve and Homebush Bay, and providing privacy to park front development.
- O25 Provide neighbourhood open space as a gathering point in the mixed use zone close to the railway station, near the junction of the major pedestrian routes to the foreshore and retail complex.
- O26 Provide local parks along Shoreline Drive to enhance the amenity of this primary through street, which have quality landscaping, trees for shade and areas for supervised children's play.
- O27 Provide strategically positioned local parks and squares in the B4 - Mixed Use and R4 - Residential Zones to provide places for people to meet, gather, sit, actively use or relax.
- O28 Maximise public pedestrian and cycle access to all public open spaces.
- O29 Create high quality landscaped parks that include deep soil landscape areas, that allow planting of large trees.

*Integrate best practice ESD principles in the design and management of the public and private domain*

- O30 Minimise energy consumption by creating low maintenance environments and encouraging green supply electricity.
- O31 Minimise resource deletion by selecting environmentally sustainable building materials in the public and private domain.
- O32 Control the quality of water entering Homebush Bay by integrating stormwater management strategies.
- O33 Conserve water by maximising opportunities for infiltration of runoff, reducing irrigation

requirements through the planting of locally indigenous species, and using water saving devices in public amenities.

- O34 Control the potential impact on air quality by minimising car dependency, promoting pedestrian and cyclist movement throughout the site and encouraging the use of public transport.
- O35 Reduce energy consumption by encouraging non-motorised forms of transport.

*Optimise the use of public transport and reduce travel demand*

- O36 Provide a mix of residential, community, employment, local and district retail activities within the Rhodes Peninsula.
- O37 Concentrate public accessible facilities, commercial development and the entrance to retail facilities with direct and convenient access to Rhodes Station, within 500m of the station entrance.
- O38 Maximise access to Rhodes Station by creating a permeable layout of streets, pedestrian arcades and walkways, and create an appropriate setting in terms of pedestrian access, facilities and modal change.
- O39 Create a primary retail/commercial street linking Mary Street and a retail centre adjacent to Homebush Bay Drive.
- O40 Enable local shops and home based business in residential areas, along Walker Street, within and adjacent the Foreshore Park to complement community facilities, and fronting onto local parks.
- O41 Minimise public and private car parking in all developments.
- O42 Accommodate a bus route through Rhodes West in the design of streets and connecting bus routes to Wentworth Point over the Homebush Bay Bridge.
- O43 Promote cycling as a sustainable alternative to the automobile for commuting as well as for local travel through the provision of an integrated on-road and off-road cycleway network and the provision of bicycle parking within private developments as well as at key activity places in the public domain including Rhodes Railway Station.
- O44 Minimise car dependence by encouraging car sharing by providing dedicated on-street spaces for car share companies to use.

*Enliven the public domain and encourage walking by distributing active uses, including retail and communal facilities, at street level, particularly along major streets in the mixed use zone*

- O45 Consolidate mixed uses including publicly accessible facilities, local retail and commercial adjoining Rhodes Railway Station.
- O46 Encourage active ground floor uses on primary streets, in particular along the major spine connecting Rhodes Station and the retail centre adjacent to Homebush Bay Drive.
- O47 Encourage activities in, and surveillance of, all public areas.
- O48 Provide publicly accessible facilities and small scale retailing adjoining and opposite parks and squares, including facilities that accommodate or are ancillary to recreational opportunities relating to the use of the public domain.

*Embody ESD principles into the design of buildings and external spaces*

- O49 Create street blocks that facilitate subdivision and building orientation to the north, east and west, provide excellent address to Homebush Bay, the foreshore parks and local parks and that follow the design guidelines within SEPP65.
- O50 Encourage the design of long life buildings that are durable and designed to accommodate adaptation to future uses, and buildings that innovatively combine ecological, social, cultural and economic objectives.
- O51 Conserve energy by maximising the use of natural lighting and ventilation, passive heating and cooling, energy efficient hot water heating and low energy lighting and appliances.
- O52 Minimise resource depletion by the selection of environmentally sustainable building materials.
- O53 Providing on site facilities for composting, recycling and bulky goods.
- O54 Conserve water by matching water quality with its intended use and using water saving devices.
- O55 Conserve water by connecting Rhodes West to the water conservation infrastructure known as WRAMS at Sydney Olympic Park, if available.

- O56 Maximise water quality by implementing soil erosion and sedimentation control measures during remediation and construction phases, maximising opportunities for infiltration of stormwater, and minimising nutrients and pollution in urban runoff.
- O57 Control the potential impact on air quality by minimising reliance on cars, provision of bicycle parking within the basement and providing information to respective residents about the transportation alternatives to private motor vehicles, requiring car share arrangements to integrate into developments and the public domain and the continuance of the reduced on-site parking requirements for private development.
- O58 Reduce landfill by:
  - » Minimising the generation of waste;
  - » Recycling 80% of weight of construction waste.

*Create a model suburb characterised by high quality architecture, landscape architecture, and urban and environmental design which enhances the locality*

- O59 Promote a high quality of architectural and landscape design, to create a strong identity for all new development.
- O60 Encourage design excellence in architectural and landscape design and follow the design guidelines within SEPP65.
- O61 Create an architectural character specific to urban location, public domain interface and landscape setting.
- O62 Encourage built form that creates a positive urban edge to streets and public open spaces and the foreshore of Homebush Bay.
- O63 Encourage built form that optimises sun access to new and existing streets and public open spaces.
- O64 Minimise the bulk of tower and tall buildings to protect amenity of adjoining residential areas and parklands.
- O65 Encourage built form that has articulated facades to create visually interesting building forms and to assist in breaking up building bulk.
- O66 Create private internal and external environments that achieve a high level of amenity to building occupants and neighbours and that create pleasant streetscapes.